

User's Manual

PLZ-5W Series Electronic Load

PLZ205W

PLZ405W

PLZ1205W

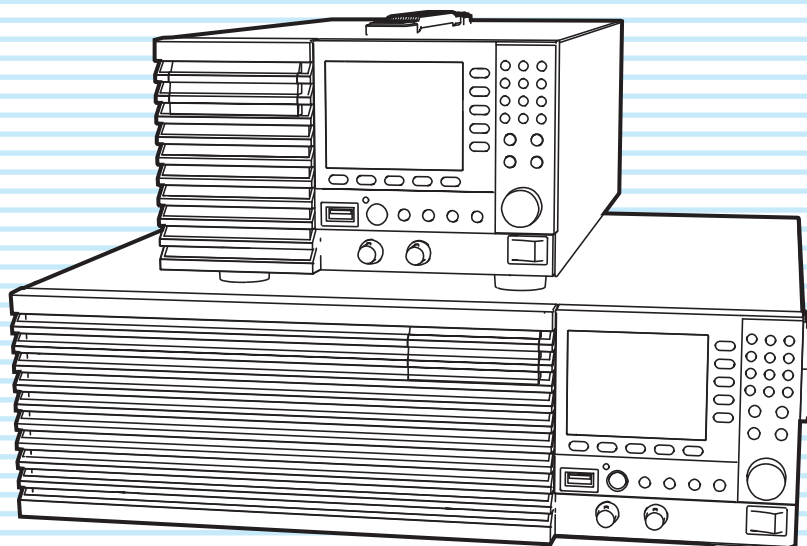

Contents 5

Component Names 8

Installation and Preparation 12

Basic Functions 19

Advanced Functions 54

Sequence Function 74

External Control 91

Parallel Operation 105

System Settings 111

Maintenance 127

Specifications 128

Appendix 141









About the PLZ-5W Series Manuals

These manuals provide an overview of the product and notes on usage. They also explain how to configure it, operate it, perform maintenance on it, and so on. Read these manuals thoroughly before use, and use the product properly.

Who should read these manuals?

These manuals are intended for users of this product and their instructors. Explanations are given under the presumption that the reader has knowledge of power supplies.

PLZ-5W series manual construction

- User's manual  (this manual)
This manual is intended for first-time users of this product. It provides an overview of the product, notes on usage, and specifications. It also explains how to connect the product, configure the product, operate the product, perform maintenance on the product, and so on.
- Communication Interface Manual  (partially in PDF)
This document contains details about remote control. It is written for readers with sufficient basic knowledge of how to control testers and measuring instruments using SCPI commands..
- Quick Reference  
This document briefly explains the PLZ-5W panel and the basic operation of it.
- Setup Guide  
This guide is intended for first-time users of the product. It gives an overview of the product, connecting procedures, safety precautions, etc. Please read this manual before you operate the product.
- Safety Information  
This document contains general safety precautions. Keep them in mind and make sure to observe them.

PDF and HTML files are included in the accompanying CD-ROM. The newest version of the operation manual can be downloaded from Download service of Kikusui website.

Firmware versions that this manual covers

This manual covers firmware versions 1.0X.
For information on how to check the current firmware version, see 「Displaying the Device Information」 (p.126) .
When contacting us about the product, please provide us with the following information.

Model (marked in the top section of the front panel)

Firmware version (p.126)

The serial number (marked on the rear panel)

Trademarks

Microsoft is a registered trademark or trademark of Microsoft Corporation in the United States and/or other countries.

All company names and product names used in this document are trademarks or registered trademarks of their respective companies.

Copyrights

The contents of this document may not be reproduced, in whole or in part, without the prior consent of the copyright holder.

The specifications of this product and the contents of this document are subject to change without prior notice.

Copyright© 2016 Kikusui Electronics Corporation

Accessories

The attached power cord varies depending on the shipment destination.

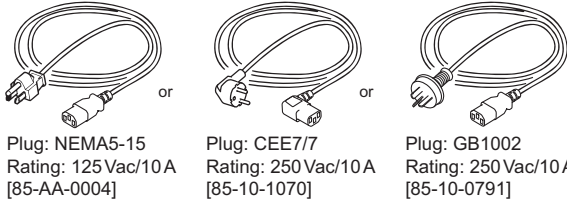

- Power cord (1 pc., length: 2.5 m)

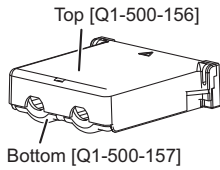

- Rear-panel load input terminal cover (1 pc.)

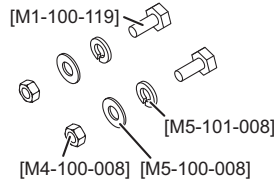

- Load input terminal screw set (2 sets)

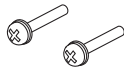

- Screws for the rear-panel load input terminal cover (2 pcs.) [M3-112-018]

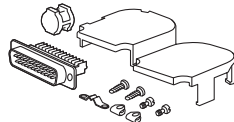

- External control connector kit (1 set) [83-20-0190]

Washer [M9-000-013]
Spring washer [M5-103-001]

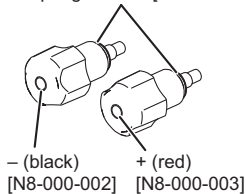

- Front-panel load input knob set (1 set)

Screw [M8-600-021]



- Front-panel load input terminal cover (1 pc.)

- Setup Guide (1 pc.)

- Quick Reference (Japanese (1 sheet), English (1 sheet))

- CD-ROM (1 disk)

- Safety Information (1 pc.)

- China RoHS sheet (1 sheet)

Product Overview

The PLZ-5W Series Electronic Load is a multifunctional system designed to offer the highest levels of reliability and safety. The electronic load contains a stable and high-performance current control circuit that enables high-speed load simulations. Designed to allow high-precision current setting, it provides outstanding resolution.

Because the electronic load comes standard with RS232C, USB, and LAN communication functions, it can easily be incorporated into a wide range of inspection systems.

PLZ-5W series lineup

| Model | Maximum operating current | Operating voltage | Power |
|-------------|---------------------------|-------------------|--------|
| PLZ205W | 40 A | 0.25 V to 150 V | 200 W |
| PLZ405W | 80 A | 0.25 V to 150 V | 400 W |
| PLZ1205W | 240 A | 0.25 V to 150 V | 1200 W |
| PLZ2405WB*1 | 480 A | 0.25 V to 150 V | 2400 W |

*1. PLZ1205W dedicated booster

Features

In addition to basic constant current, constant resistance, constant voltage, and constant power modes, the PLZ-5W Series offers a variety of other functions. The PLZ-5W Series also provides better performance than previous models.

High-speed response

The rise time has been improved from 10 μ s to 5 μ s.

Expanded voltage range

The minimum operating voltage has been improved from 1.5 V to 0.25 V, offering support of low voltage input.

Arbitrary I-V characteristics mode

Arbitrary I-V characteristics mode that allows current to be set arbitrarily in relation to voltage input. This mode can be used for simulation of LED loads and the like.

Color liquid crystal display (LCD)

Allows easy-to-see display in color. The voltage value, current value, power value, current capacity value (Ah), and power capacity value (Wh) at the load input terminal are indicated on the display.

Increased power capacity and current capacity

Power capacity and current capacity 1.2 times those of previous models have been realized while keeping the size unchanged.

Larger capacity achievable

Larger capacity can be achieved by connecting optional boosters (PLZ2405WB) to the PLZ1205W. Up to four booster units can be operated in parallel using a PLZ1205W unit as the master unit (up to 10.8 kW, 2160 A).

Support of synchronized operation

Load on/off control and the execution of sequences can be synchronized for multiple PLZ-5W units.

RS232C, USB, and LAN communication functions provided as standard

These functions allow easy incorporation into various types of inspection systems.

GPIB function available as option*

Using the optional GPIB converter (p.171), the GPIB function can be used via the RS232C or USB interface.

* Limitation apply to some of the functions.

Notations Used in This Manual

- In this manual, electronic load PLZ205W, PLZ405W, or PLZ1205W is sometimes referred to as PLZ-5W.
- The term "PC" is used to refer generally to both personal computers and workstations.
- The term "DUT" is used to refer generally to a device under test.
- The screen captures and illustrations used in this text may differ from the actual items.
- The following markings are used in the explanations of this text.

WARNING

Indicates a potentially hazardous situation which, if ignored, could result in death or serious injury.

CAUTION

Indicates a potentially hazardous situation which, if ignored, may result in slight injury or damage to the product or other property.

NOTE

Indicates information that you should know.



Indicates a reference manual (CD-ROM) containing detailed information.



Indicates the hierarchy of items you need to select. The item to the left of this symbol indicates a higher level item.

Safety Precautions

When using this product, be sure to observe the precautions in the Safety Information manual. Items specific to this product are given below.

CAUTION

- The rear panel may become hot during operation. If you touch it, you may burn yourself.
- Do not install the product vertically. It may cause injury to the operator or damage to the product when it falls down.
- Do not use the product where ventilation is poor. Heat is expelled from vents of the rear panel. To prevent the heat from building up and causing a fire, keep the vents at least 60 cm away from walls. Also, do not place objects within 60 cm of the rear panel.

Notes on Usage

- When installing this product, be sure to observe the temperature and humidity ranges indicated below.
Operating temperature range: 0 °C to 40 °C (32 °F to 104 °F)
Operating humidity range: 20 %rh to 85 %rh (no condensation)
- When storing this product, be sure to observe the temperature and humidity ranges indicated below.
Storage temperature range: -20 °C to 70 °C (-4 °F to 158 °F)
Storage humidity range: 90 %rh or less (no condensation)

Notes on transportation

Remove the cover for the load input terminals and the load input knob set on the front panel from this product before transporting.

Transporting the product with these attached may cause damage.

Contents

| | |
|---------------------------------------|---|
| About the PLZ-5W Series Manuals | 2 |
| Accessories | 3 |
| Product Overview | 3 |
| Notations Used in This Manual..... | 4 |
| Safety Precautions | 4 |
| Notes on Usage..... | 4 |
| Component Names | 8 |

Installation and Preparation

| | |
|----------------------------------------------------------------|----|
| Connecting the Power Cord | 12 |
| Checking Whether the Power Is On or Off | 13 |
| Turning the power on..... | 13 |
| Turning the power off..... | 13 |
| Connecting to the DUT | 14 |
| Connecting to the load input terminals on the rear panel..... | 15 |
| Connecting to the load input terminals on the front panel..... | 17 |
| Notes regarding load input terminals..... | 18 |

Basic Functions

| | |
|---------------------------------------------|----|
| Panel Operations..... | 19 |
| Switching the display..... | 19 |
| Using the function keys | 20 |
| Inputting numbers and characters | 22 |
| Changing values..... | 23 |
| Load On/Off..... | 24 |
| Setting the Operation Mode | 25 |
| Setting the operation mode | 25 |
| Setting the current in CC mode | 26 |
| Setting the conductance in CR mode | 26 |
| Setting the voltage in CV mode | 27 |
| Setting the power in CP mode..... | 27 |
| Setting the load value in CC+CV mode..... | 28 |
| Setting the load value in CR+CV mode..... | 29 |
| Setting the load value in ARB mode..... | 30 |
| Setting the Current Range and Voltage Range | 34 |
| Setting the Slew Rate | 35 |
| Setting the Short Function | 36 |
| Switching Function | 37 |
| Setting the switching level | 37 |
| Setting the switching interval..... | 38 |

| | |
|-------------------------------------------------------------------|----|
| Turning the switching function on/off..... | 39 |
| Timing of trigger signal output..... | 39 |
| Alarm Function | 40 |
| Alarm types and operation | 40 |
| Setting overcurrent protection (OCP)..... | 42 |
| Setting overpower protection (OPP)..... | 43 |
| Setting undervoltage protection (UVP)..... | 44 |
| Setting watchdog protection (WDP)..... | 45 |
| When an alarm occurs | 45 |
| Clearing an alarm..... | 46 |
| Recording Measurements | 47 |
| Starting measurement recording..... | 47 |
| Obtaining measurements | 47 |
| Setting recording conditions..... | 48 |
| Aborting a measurement recording..... | 50 |
| Recording Integrated Data | 51 |
| Recording current capacity, power capacity, and elapsed time..... | 51 |
| Showing or hiding integrated data..... | 53 |

Advanced Functions

| | |
|-----------------------------------------------|----|
| Changing the Response Speed | 54 |
| Soft Start | 55 |
| Remote Sensing..... | 56 |
| Connecting the sensing cables | 56 |
| Enabling or disabling remote sensing | 57 |
| Auto Load Off Timer..... | 58 |
| Types of Memory | 59 |
| ABC Preset Memories..... | 60 |
| Saving to ABC preset memories | 61 |
| Recalling ABC preset memory entries | 62 |
| Setup Memory..... | 63 |
| How to view the setup memory edit screen..... | 63 |
| Saving to the setup memory..... | 64 |
| Checking the setup memory details | 66 |
| Recalling the setup memory..... | 66 |
| Synchronized Operation..... | 67 |
| Connection for synchronized operation..... | 67 |
| Synchronizing the load on/off operation..... | 69 |
| Synchronizing measurement recording..... | 70 |
| Synchronizing the start of sequences | 71 |
| Synchronizing the resuming of sequences..... | 72 |
| Aborting synchronized operation..... | 72 |
| Remote Control..... | 73 |
| Releasing remote control | 73 |

Sequence Function

| | |
|-------------------------------------------------------|----|
| Overview of the Sequence Function..... | 74 |
| Programs and steps..... | 74 |
| Main functions..... | 74 |
| Program Configuration..... | 75 |
| How to view the program editing screen..... | 75 |
| Creating a program..... | 75 |
| Setting the number of loops..... | 76 |
| Setting the voltage of CV mode addition (+CV)..... | 77 |
| Setting protection functions..... | 78 |
| Changing a program name..... | 79 |
| Deleting a program..... | 79 |
| Setting Steps..... | 80 |
| Creating steps..... | 80 |
| Deleting steps..... | 83 |
| Sequence Creation Tutorial..... | 84 |
| Creating Program1 as a new program..... | 84 |
| Registering steps to Program1..... | 85 |
| Executing, Pausing, and Stopping Sequences..... | 88 |
| Executing a sequence..... | 88 |
| Pausing a sequence..... | 89 |
| Aborting a sequence..... | 89 |
| Controlling the start of sequences with triggers..... | 89 |

External Control

| | |
|---------------------------------------------------------------------------------------|-----|
| Preparation for External Control..... | 91 |
| Precautions for high-speed load simulations..... | 91 |
| EXT CONT connector pin arrangement..... | 92 |
| Connecting to the EXT CONT connector..... | 93 |
| Load Setting Control..... | 95 |
| Constant current (CC), constant resistance (CR), and constant power (CP) control..... | 95 |
| Constant voltage (CV) control..... | 96 |
| Controlling the current to be superimposed on the constant current (CC)..... | 97 |
| Controlling Load On/Off..... | 98 |
| Load on/off control input..... | 98 |
| Load-on status signal output..... | 99 |
| Current Range Control..... | 100 |
| Range control input..... | 100 |
| Range status output..... | 100 |
| Controlling Alarms..... | 101 |
| Alarm input..... | 101 |
| Alarm clearing input..... | 101 |
| Alarm status output..... | 101 |
| Trigger Input/Output..... | 102 |
| Trigger input..... | 102 |
| Trigger output..... | 102 |

| | |
|---------------------------------------|-----|
| Digital I/O..... | 103 |
| Using the Current Monitor Signal..... | 104 |
| Current monitor output..... | 104 |

Parallel Operation

| | |
|-------------------------------------------------------------------------------------------|-----|
| Overview of Parallel Operation..... | 105 |
| Parallel Operation Using the Same Model..... | 106 |
| Making connections for parallel operation..... | 107 |
| Performing parallel operation..... | 109 |
| Slew rate and response speed settings during parallel operation..... | 109 |
| Protection function during parallel operation (parallel operation anomaly detection)..... | 109 |
| Canceling parallel operation..... | 110 |

System Settings

| | |
|---------------------------------------------------------------------|-----|
| Displaying and Changing CONFIG Settings .. | 111 |
| Remote sensing..... | 111 |
| Panel settings at startup..... | 112 |
| Watchdog protection setting (WDP)..... | 112 |
| Screen saver..... | 113 |
| Key lock..... | 114 |
| Setting the beep sound..... | 115 |
| Setting the DIGITAL2 signal input/output..... | 115 |
| Displaying/Changing the Interface Settings ... | 116 |
| Resetting the interface settings..... | 117 |
| Returning the interface settings to the factory default values..... | 118 |
| Displaying SCPI Errors..... | 119 |
| Setting the Date/Time..... | 120 |
| Factory Default Settings and Reset Settings.. | 121 |
| Restoring the factory default settings..... | 121 |
| Restoring the reset settings..... | 122 |
| Main settings at factory default and at reset..... | 123 |
| Updating..... | 125 |
| Displaying the Device Information..... | 126 |

Maintenance

| | |
|---------------------------------|-----|
| Inspection..... | 127 |
| Overhaul..... | 127 |
| Backup battery replacement..... | 127 |
| Calibration..... | 127 |

Specifications

| | |
|-----------------------------------------------|-----|
| Ratings | 128 |
| Constant current (CC) mode | 129 |
| Constant resistance (CR) mode | 130 |
| Constant voltage (CV) mode | 130 |
| Constant power (CP) mode | 131 |
| Arbitrary I-V characteristics (ARB) mode..... | 131 |
| Measurement function | 131 |
| Switching function..... | 132 |
| Slew rate..... | 133 |
| Soft start..... | 133 |
| Alarm Function | 134 |
| Sequence function..... | 134 |
| Other functions | 135 |
| Common specifications | 136 |
| General specifications | 138 |
| External dimensions | 139 |

| | |
|-----------------------|-----|
| Troubleshooting | 173 |
|-----------------------|-----|

| | |
|-------------|-----|
| Index | 175 |
|-------------|-----|

Appendix

| | |
|------------------------------------------------------------------|-----|
| Selecting the Load Cables | 141 |
| Methods to Stabilize Operation | 143 |
| Reducing the load cable inductance..... | 143 |
| Optimizing the response speed..... | 144 |
| Using remote sensing..... | 145 |
| Slew Rate for Small Currents | 146 |
| Operating Area | 147 |
| Basic operation modes | 147 |
| Operation of the constant current (CC) mode | 148 |
| Operation in constant resistance (CR) mode | 149 |
| Constant power (CP) mode operation | 151 |
| Constant voltage (CV) mode operation | 152 |
| Operation when CV mode is added to CC mode | 154 |
| Operation when CV mode is added to CR mode | 155 |
| Operating area of each model | 157 |
| Response Time and Waveform When an OPP Is Activated..... | 160 |
| Response time..... | 160 |
| waveform | 161 |
| Operating Range during Parallel Operation ... | 163 |
| Parallel operation using the same type of electronic loads | 163 |
| Parallel operation using boosters | 165 |
| Options | 167 |
| Rack adapters, brackets..... | 167 |
| GPIB converter (PIA5100)..... | 171 |
| Parallel operation signal cable kit (PC01-PLZ-5W) .. | 171 |
| Low inductance cable | 171 |
| Large current load cable..... | 172 |

Component Names

Front panel

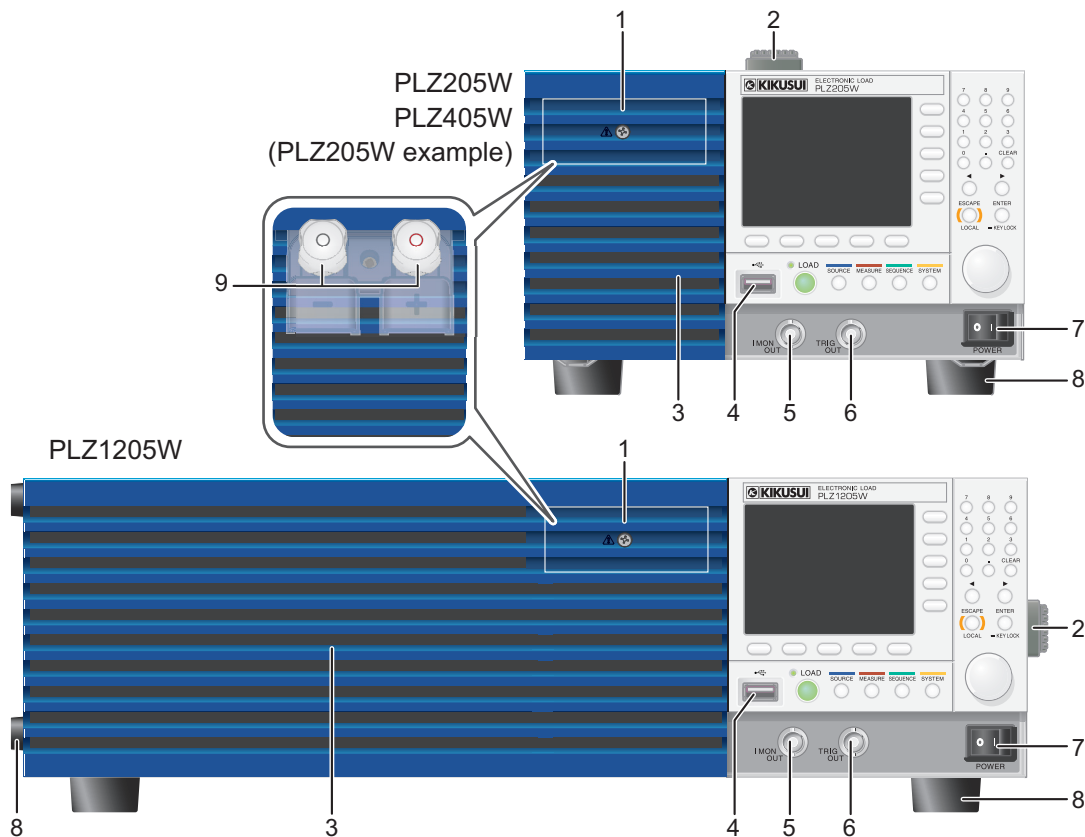

| No. | Name | Function | See |
|-----|----------------------------------------------------------------------------------|---------------------------------------------------------------------------------------------------------------------------------------------------------------------------------------------------------------------------------------------------------------------------------------------------------|-----------------------------------------------------------------------|
| 1 | Protection plate | This plate protects the load input terminal on the front panel. The DUT and the PLZ-5W can be connected by removing the protection plate and attaching the front panel load input terminal cover. When not using the DC load input terminal on the front panel, be sure to attach the protection plate. | p.17 |
| 2 | Handle | Handle for carrying the PLZ-5W. | p.168 |
| 3 | Air inlet | Inlet holes for cooling. | — |
| 4 | USB connector (host) | This connector is used to connect an external keyboard, save the setup memory, and perform updates. | p.22 p.64 p.125 |
| 5 | I MON OUT connector | Current monitor output terminal. | p.104 |
| 6 | TRIG OUT terminal | Trigger signal output terminal. | p.102 |
| 7 | POWER switch | Press the (I) side to switch the power on, and the (O) side to switch the power off. | p.13 |
| 8 | Feet | PLZ205W/PLZ405W: 4 locations on bottom panel. PLZ1205W: 4 locations on bottom panel, 4 locations on side panel. | p.168 |
| 9 | DC INPUT terminal on the front panel (Load input terminal on the front panel) | Used for simple connection with the DUT. The specifications are for the load input terminal on the rear panel and the load input terminal on the front panel may not meet the specifications. | p.17 |



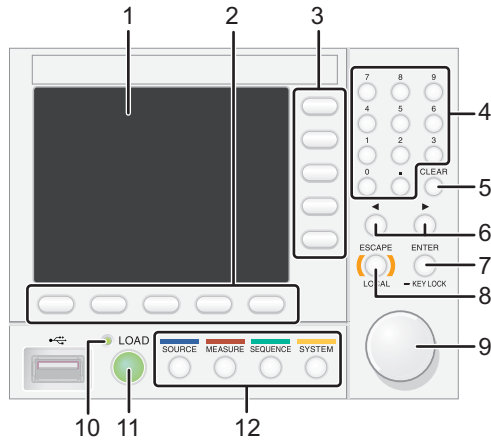



Controls

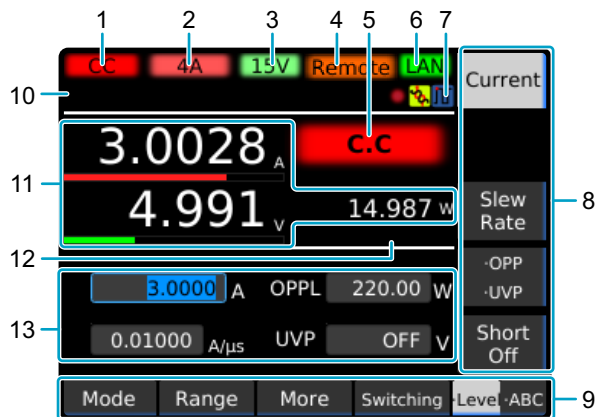

| No. | Name | Function | See |
|-----|--------------------------|---------------------------------------------------------------------------------------------------------------------------------------------------------------------------------------------------------------------------------------------------------------------------------------------------------------------------------------|-----------------------------------------------|
| 1 | Display area | Displays the settings, measured values, and other information. | p.10 |
| 2 | Function keys | Each function key executes the item that is displayed above that key (function area). | p.20 |
| 3 | Sub-function keys | Each sub-function key executes the item that is displayed to the left of that key (sub-function area). | p.20 |
| 4 | Numeric keypad | Enters values. | p.22 |
| 5 | CLEAR key | Deletes numbers/characters. | p.22 |
| 6 | ◀▶ keys | Move the cursor left and right. Select the left or right item. | p.22 |
| 7 | ENTER key KEYLOCK key | Confirms the input value when performing numeric keypad input. Confirmation after selection of setting item. Hold down to lock the keys. | p.22 p.114 |
| 8 | ESCAPE key LOCAL key | Cancels numeric/character input. Closes the window. Returns remote control to panel operation. | p.22 p.73 |
| 9 | Rotary knob | Item selection. Inputs numbers/characters. | p.22 |
| 10 | LOAD LED | Lit when the load is on. | – |
| 11 | LOAD key | Turns the load on and off. | p.24 |
| 12 | Menu key | Switches the display. | p.19 |
| | SOURCE key | Operation mode and load value settings, voltage and current range settings, slew rate, short, switching, alarm, response speed, soft start, auto load off timer, ABC preset memories, load on/off synchronization, measurement recording synchronization, sequence synchronization, sequence start trigger setting, external control. | – |
| | MEASURE key | Measurement function, measurement trigger function, integrated data recording/display, etc. | p.47 p.51 |
| | SEQUENCE key | Functions related to sequence. | p.74 |
| | SYSTEM key | Remote sensing, system settings, interface settings, setup memory, SCPI error display, date setting, restore factory default setting, update, device information display. | p.111 |

Display



| No. | Name | Function | See |
|-----|-------------------------------------------------------------------------------------|------------------------------------------------------------------------------------------------------------------------------------------------------------------------------|-----------------------|
| 1 | Selected operation mode. | Displays the selected operation mode. | p.25 |
| 2 | Current range | Displays the current range. | p.34 |
| 3 | Voltage range | Displays the voltage range. | p.34 |
| 4 | Remote | Indicates that the product is being controlled remotely. | p.73 |
| 5 | Operation mode in use | Displays the currently running operation mode. | p.25 |
| 6 | LAN | Displays the status of the LAN connection. Green: Communication enabled. Orange: Preparing for communication. Red: Not connected. | – |
| 7 | Icon | – | – |
| |  | Indicates that the switching function is currently being used. | p.39 |
| |  | Indicates that measured values are being recorded. | p.47 |
| |  | Indicates that remote sensing is in progress. | p.56 |
| |  | Indicates that key lock is on. The key lock level is displayed numerically. | p.114 |
| |  | Sequence in progress. | p.88 |
| |  | Indicates that an SCPI error has occurred. The number of error incidents (up to 16) is displayed numerically. | p.119 |
| 8 | Sub-function area | Indicates that execution is possible with the keys (sub-function keys) in the right side of the display. | p.20 |
| 9 | Function area | Indicates that execution is possible with the keys (function keys) at the bottom of the display. | p.20 |
| 10 | Message area | Displays alarm messages. | p.40 |
| 11 | Measured values | Displays the current, voltage, and power values. The load input ratio for the rating of each range is displayed in bar graph form under the current value and voltage value. | – |
| 12 | Integrated data | Displays the integrated data when integrated data display is enabled. | p.53 |
| 13 | Value | Displays load values (current, conductance, voltage, power) and other settings such as slew rate and alarm operating conditions. | – |

Rear panel

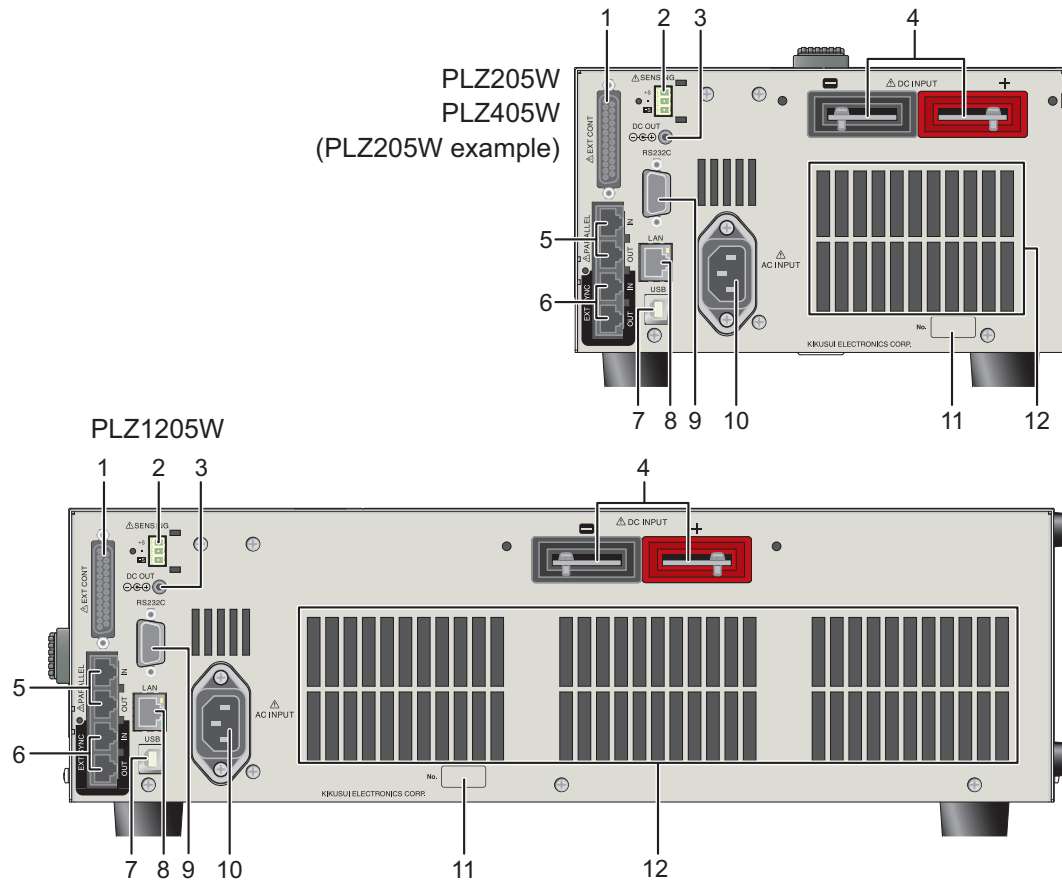

| No. | Name | Function | See |
|-----|--------------------------------------------------------------------------------|---------------------------------------------------------------|---------------------------------------------------------------------------------------|
| 1 | EXT CONT connector | External control connector. A cover for the pins is provided. | p.91 |
| 2 | SENSING connector | Remote sensing connector. | p.56 |
| 3 | DC OUT connector | Used during GPIB converter (option) use. | p.171 |
| 4 | DC INPUT terminal on the rear panel (load input terminal on the rear panel) | Used to connect the DUT and the PLZ-5W. | p.14 |
| 5 | PARALLEL connector | Connector for parallel operation. | p.106 |
| 6 | EXT SYNC port | Connector for synchronized operation. | p.67 |
| 7 | USB port (device) | USB port for remote control. |  |
| 8 | LAN port | LAN port for remote control. | Interface Manual |
| 9 | RS232C port | RS232C port for remote control. | |
| 10 | AC INPUT connector | Power inlet. | p.12 |
| 11 | Serial number | PLZ-5W manufacturing number. | – |
| 12 | Air outlet | Air outlet for cooling. | – |

Installation and Preparation

Connecting the Power Cord

WARNING

Risk of electric shock.

- The PLZ-5W conforms to IEC Safety Class I (equipment that has a protective conductor terminal). Be sure to earth ground the product to prevent electric shock.
- The PLZ-5W is grounded through the power cord ground wire. Connect the protective conductor terminal to earth ground.

NOTE

- Use the included power cord to connect to the AC line. If the supplied power cord cannot be used because the rated voltage or the plug shape is incompatible, have a qualified engineer replace it with an appropriate power cord that is 3 m or less in length. If obtaining a power cord is difficult, contact your Kikusui agent or distributor.
- The power cord with a plug can be used to disconnect the PLZ-5W from the AC power line in an emergency.
- Secure adequate space around the power cord plug. Do not insert the power cord plug into an outlet that is difficult to access or place objects around the power cord plug that will make plugging and unplugging difficult.
- Do not use the supplied power cord with other instruments.

The PLZ-5W conforms to IEC Overvoltage Category II (energy-consuming equipment that is supplied from a fixed installation).

1 Turn the **POWER switch off (O)**.

2 Check that the **AC power line meets the nominal input rating of the PLZ-5W**.

The PLZ-5W can receive a nominal line voltage in the range of 100 Vac to 240 Vac at 50 Hz or 60 Hz. (Frequency range: 47 Hz to 63 Hz)

3 Connect the power cord to the **AC INPUT inlet on the rear panel**.

4 Connect the power cord plug to a properly grounded outlet.

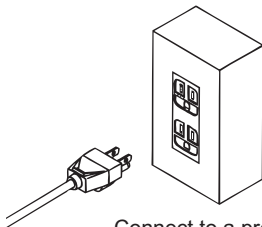

Connect to a properly grounded outlet.

This completes the setting.

Checking Whether the Power Is On or Off

Turning the power on

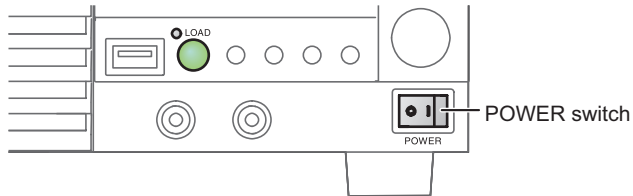

- 1** Check that the power cord is connected correctly.
- 2** Check that nothing is connected to the DC INPUT (load input) terminals on the front and rear panels.
- 3** Turn the POWER switch on (I).

The PLZ-5W turns on, and the display lights.

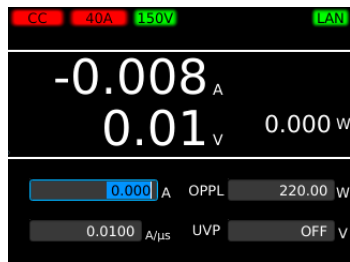

If you notice strange sounds, unusual odors, fire, or smoke around or from inside the PLZ-5W, turn the POWER switch off, or remove the power cord plug from the outlet.

By factory default, the panel settings immediately before the POWER switch is turned off are saved. When you turn the power on, the PLZ-5W starts in the same state as it was in the last time it was turned off. (However, the load setting is always Load Off.)

The panel setting state at startup can be changed ([p. 112](#)).

Turning the power off

Press the (O) side of the POWER switch to turn the power off.

CAUTION

If you want to turn the POWER switch back on, wait at least 5 seconds after the fan stops. Repeatedly turning the POWER switch on and off at short intervals will shorten the service life of the POWER switch and the internal input fuse.

Connecting to the DUT

The PLZ-5W has load input terminals on both its front and rear panels. The specifications of the PLZ-5W are for the load input terminals on the rear panel.

For information on selecting load cables, refer to “Selecting the Load Cables” (p. 141) in the “Appendix”. Large current load cables are available as options. For details, see the Large Current Load Cable Manual in the included CD-ROM.

 **WARNING**

Risk of electric shock.

- Do not touch load input terminals when the output is turned on.
- The load input terminals on the front panel are connected internally to the load input terminals on the rear panel. The voltage applied to the terminal on one side appears directly at the terminal on the other side.

 **CAUTION**

Risk of damage.

- Do not connect the DUT to the load input terminals while the product's load is turned on.
- Do not connect electronic loads to the load input terminals on the front panel and those on the rear panel at the same time.
- Do not invert the polarity when connecting. An overcurrent might flow when the load is turned on.

To avoid overheating, observe the following precaution.

- Use the supplied screws to connect the cables with crimping terminals.
-

Connecting to the load input terminals on the rear panel

Connect the DUT to the load input terminals on the rear panel.

WARNING

Risk of electric shock.

- Be sure to attach the cover for the load input terminals on the rear panel.
- Attach the protection plate or cover for the load input terminals on the front panel also to the load input terminals on the front panel. The voltage applied to the load input terminals on the rear panel appears at the load input terminals on the front panel.

1 Turn the load off.

2 Turn off the output of the DUT.

3 Attach crimping terminals to the load cables.

The load input terminals on the rear panel have bolt (M10) holes for connecting the load cables. Attach the appropriate crimping terminals to the cables.

4 Connect the load cables to the load input terminals on the rear panel using the included load input terminal screw set.

To prevent interference with the cover for the load input terminals on the rear panel, basically connect the crimping terminals in orientation (1) in the figure. If the crimping terminals are small and cannot be connected in orientation (1), connect them in orientation (2).

Tightening torque: 22.46 N·m

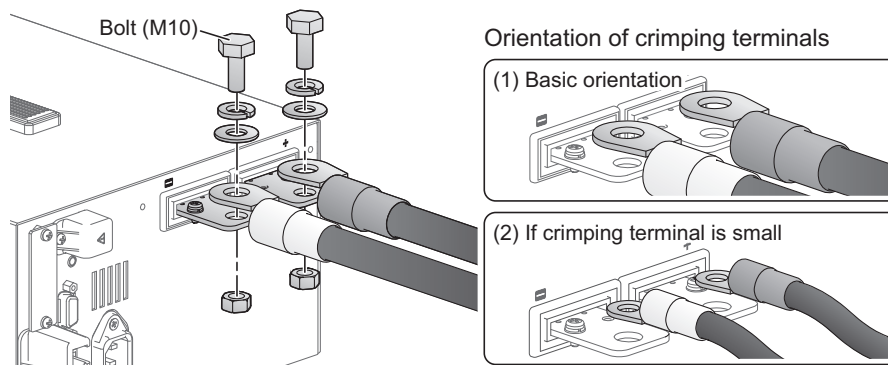

5 Place the bottom half of the cover for the load input terminals on the rear panel underneath the cables connected to the load input terminals.

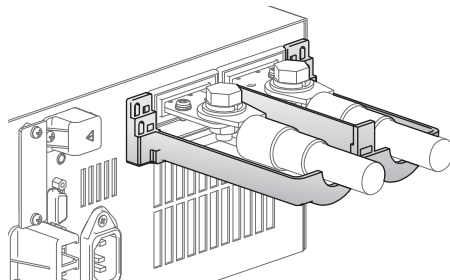

6 Align the tabs of the top cover for the load input terminals on the rear panel with those of the bottom cover.

Align the tabs of the load input terminal cover according to the load cable diameter.

You can adjust the diameter of the holes that the load cables pass through by changing the position that the top and bottom covers are put together. There are two available positions. Use the appropriate position for the load cables that you are using.

- For cables up to $\varnothing 10$ mm: Put the top and bottom load input terminal covers together so that the hole diameter is small.
- For cables that are between $\varnothing 10$ and 20 mm: Put the top and bottom load input terminal covers together so that the hole diameter is large.

For thin load cables (up to $\Phi 10$)

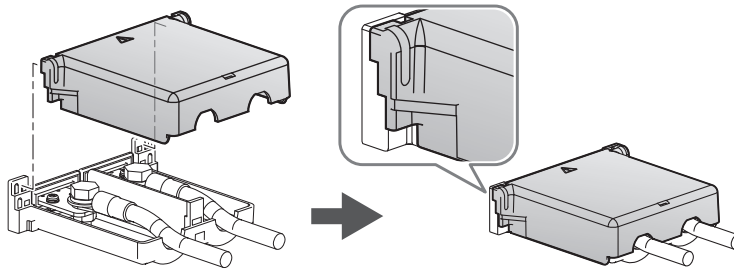

For thick load cables ($\Phi 10$ to $\Phi 20$)

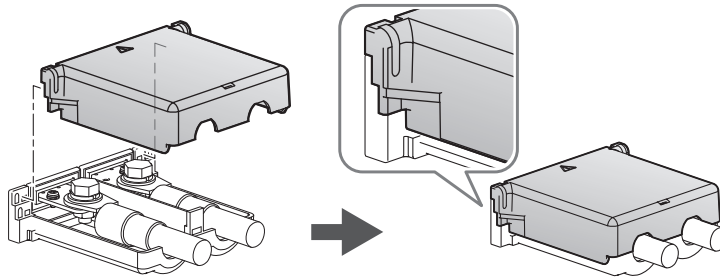

7 Push the cover for the load input terminals on the rear panel against the panel, and fasten it with the included screws.

Make sure that the screws are securely fastened.

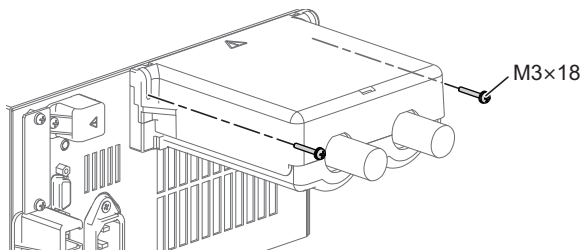

8 Connect the load cables to the output terminals of the DUT.

Connect the positive (+) polarity of the load input terminal on the rear panel to the positive (+) polarity of the DUT, and the negative (-) polarity of the load input terminal on the rear panel to the negative (-) polarity of the DUT.

This completes the connections.

Connecting to the load input terminals on the front panel

The load input terminals on the front panel enable you to easily connect the DUT to the PLZ-5W. The specifications of the PLZ-5W are for the load input terminals on the rear panel. The load input terminals on the front panel may not meet the specifications.

⚠ WARNING Risk of electric shock.

- Attach insulation caps to the crimping terminals.
- When not using the load input terminals on the front panel, be sure to attach the cover for the load input terminals on the front panel or the protection plate.
- Attach the cover for the load input terminals on the rear panel also to the load input terminals on the rear panel. The voltage applied to the load input terminals on the front panel appears at the load input terminals on the rear panel.

NOTE

The rated current value of the load input terminals on the front panel of the PLZ1205W is 80 A. When a current of 80 A or more flows to the load input terminals on the front panel, an alarm occurs and the load turns off.

- 1 Turn the **POWER** switch off.
- 2 Turn off the output of the DUT.
- 3 Remove the protection plate of the load input terminals on the front panel.

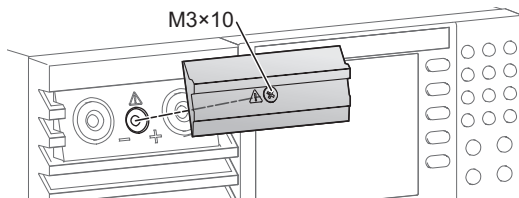

Keep the removed protection plate and screws in a safe place. By attaching the protection plate when not using the load input terminals on the front panel, the PLZ-5W can be used in a safe and compact manner.

- 4 Attach the cover for the load input terminals on the front panel.

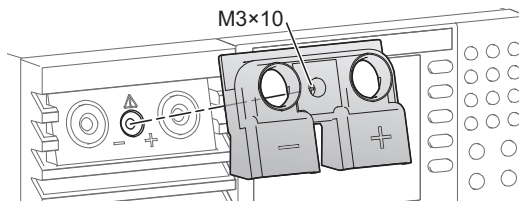

- 5 Insert the load cables from the bottom and tighten the accessory knobs to fix the cables in place.

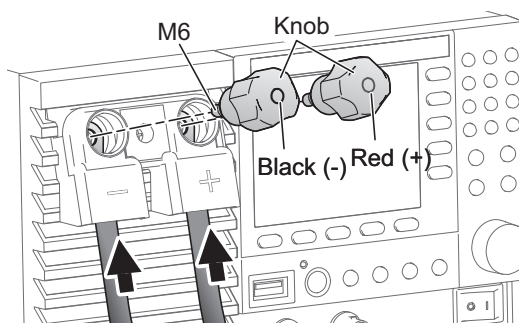

6 Connect the load cables to the output terminals of the DUT.

Connect the positive (+) polarity of the load input terminal on the front panel to the positive (+) polarity of the DUT, and the negative (-) polarity of the load input terminal on the front panel to the negative (-) polarity of the DUT.

This completes the connections.

Notes regarding load input terminals

Do not apply overvoltage to the load input terminals

CAUTION Risk of damage. Do not apply a voltage that exceeds 150 Vdc to the load input terminals.

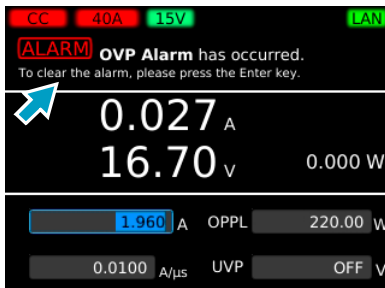

When an overvoltage of 165 V is applied when the voltage range is 150 V, or when an overvoltage of 16.5 V is applied when the voltage range is 15 V, a beeping sound is emitted and an alarm appears. If this happens, immediately lower the voltage of the DUT.

Match the wiring polarity with that of the DUT

Be careful to match the polarities of the load input terminals with those of the DUT during connection.

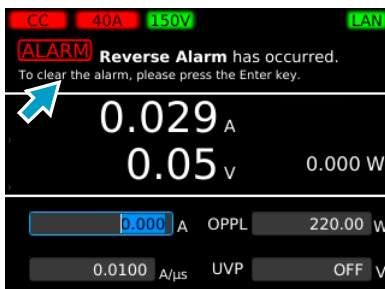
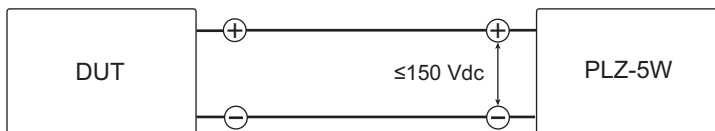

If a reverse voltage of 0.6 V or higher is applied, or a reverse current (approximately -1 % of the range rating) flows, a beeping sound is emitted and an alarm appears. If this happens, immediately turn off the POWER switch of the DUT.

Basic Functions

Panel Operations

This chapter explains the front panel operations in general.

Switching the display

There are two display modes: function display and main display. The function display shows functions that can be executed on each screen. The main display shows measured values with large numbers.

Pressing a menu key shows the function display of the corresponding menu screen. Pressing the same menu key again on the function display switches the display to the main display.

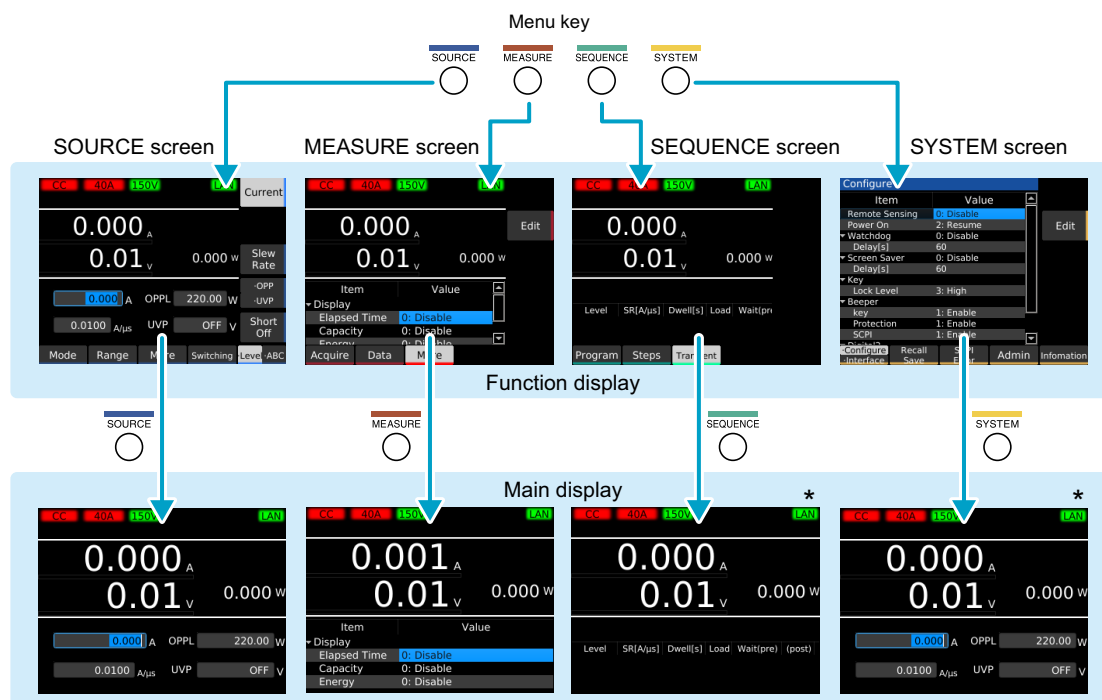

* On screens that do not show measured values (the screen that appears when the Program or Step key is pressed on the SEQUENCE screen or the SYSTEM screen), the display switches to the main display of the screen that showed measured values last.

| Menu key | Available functions |
|----------|---------------------------------------------------------------------------------------------------------------------------------------------------------------------------------------------------------------------------------------------------------------------------------------------------------------------------------------|
| SOURCE | Operation mode and load value settings, voltage and current range settings, slew rate, short, switching, alarm, response speed, soft start, auto load off timer, ABC preset memories, load on/off synchronization, measurement recording synchronization, sequence synchronization, sequence start trigger setting, external control. |
| MEASURE | Measurement recording, trigger settings for measurement recording, integrated data recording, integrated data display, measurement synchronization. |
| SEQUENCE | Sequencing, synchronizing the start of sequences. |
| SYSTEM | Remote sensing, setup memory, system settings, interface settings, SCPI error display, date/time setting, restore factory default setting, update, device information display. |

Using the function keys

On the function display (p.19), the available functions are shown in the function area and sub-function area. You can execute or select the functions by pressing the corresponding function key or sub-function key.

The selected function is shown with a light gray background.

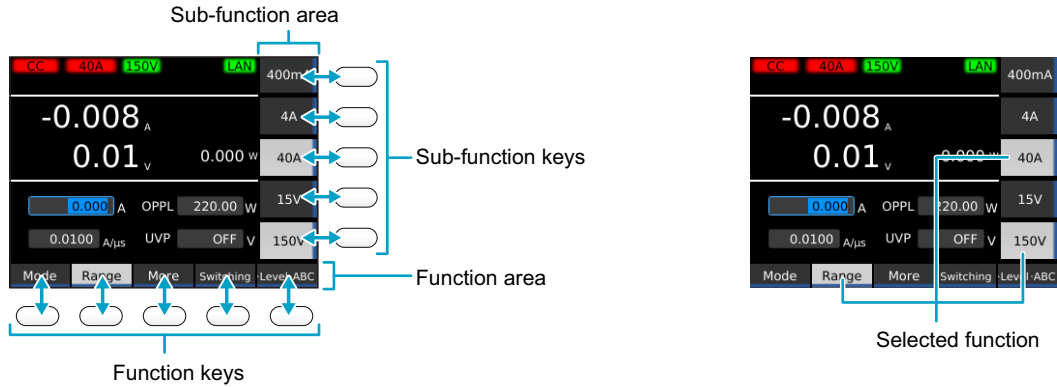

If two or more functions that can be used with a single function key are shown, you can switch between the functions by repeatedly pressing the function key.

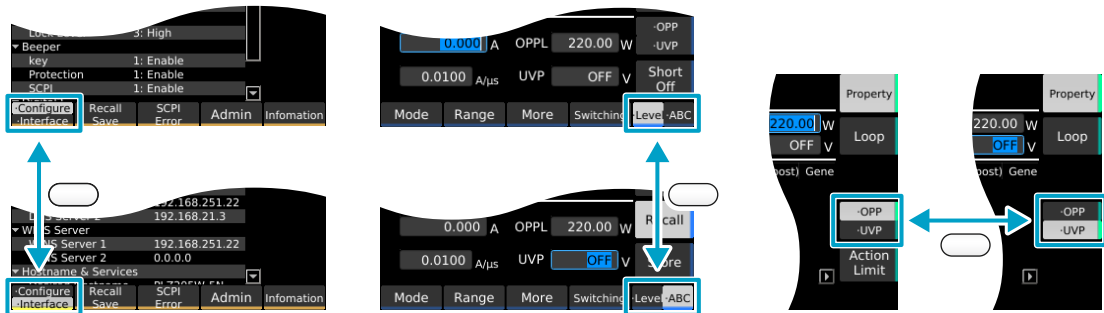

Key names

In this document, individual function keys and sub-function keys are distinguished by indicating the function names shown in the function area or sub-function area as the key names. If there are two or more functions shown, the name of the function to use is indicated as the key name.

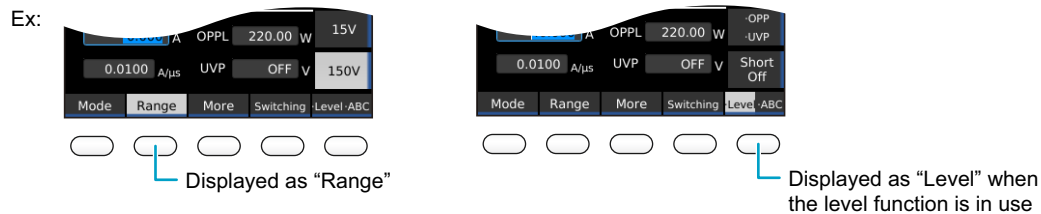

Operation example (Selection of constant resistance mode)

1 Press SOURCE, Mode, and then CR.

In the above step example, press the buttons in the following order.

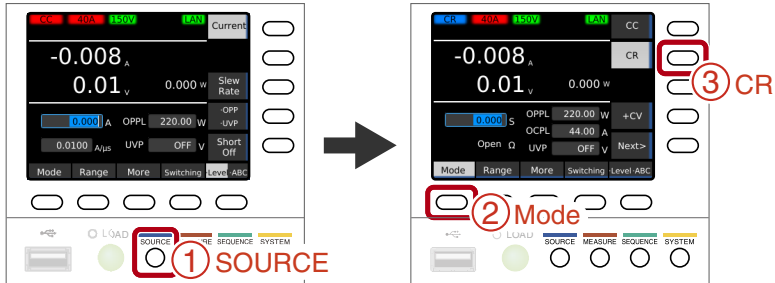

Inputting numbers and characters

You can enter numbers and characters in input areas from the front panel or external keyboard. Number input and character input switch automatically according to the input area.

If numbers or characters are selected in an input area, they can be changed. If only a cursor is shown in an input area, you can enter characters or numbers at the cursor position.

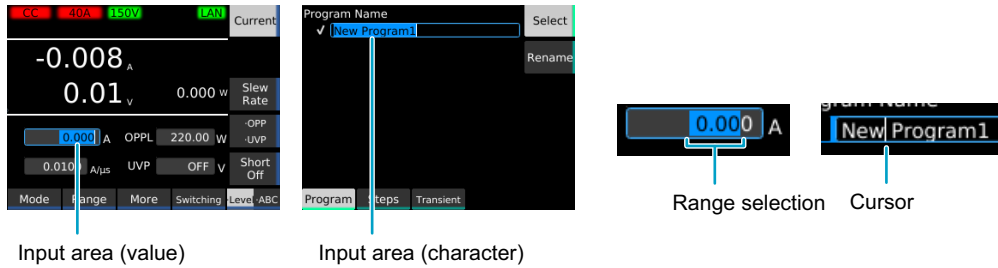

Entering from the front panel

| Purpose | Operation | Description |
|-----------------|----------------|----------------------------------------------------------------------------------------------------------------------------------------------------------------------------------------------------------------------------------------------------------------|
| Numeric input | Numeric keypad | You can enter numbers and a decimal point. Following input, press the ENTER key to confirm the value. |
| | Rotary knob | You can enter numbers. Turn clockwise to increase the value and counterclockwise to decrease. The value is confirmed immediately upon input. |
| Character input | Numeric keypad | You can enter numbers and dots. |
| | Rotary knob | Turn clockwise to enter characters in the following order: space, uppercase letters, lowercase letters, numbers, and symbols. Turn counterclockwise to enter character in reverse order. To enter the next character, press the ◀ or ▶ key to move the cursor. |
| Cursor movement | ◀/▶ keys | Changes the number of digits or input position. |
| Delete | CLEAR key | Deletes the number or character on the left of the cursor or the selected range. |
| Cancel | ESCAPE key | Cancels numeric/character input. |

Entering from an external keyboard

You can enter numbers/characters if you connect a keyboard to the USB port on the front panel. Use the arrow keys to move the cursor, the Backspace and Delete key to delete numbers and characters, the Escape key to cancel input, the Enter key to confirm, and the Tab key to move between input items.

Changing values

To change a selected value (e.g., load value), use the numeric keypad or rotary knob. If you enter a value with the numeric keypad, following input, press the ENTER key to confirm the value.



Use the numeric keypad or the rotary knob to change the value.

On screens in which “Edit” is shown in the sub-function area, use the rotary knob to select the item you want to change, and then press the Edit key or a numeric key to start changing the value. Procedures using the Edit key are provided in this document.

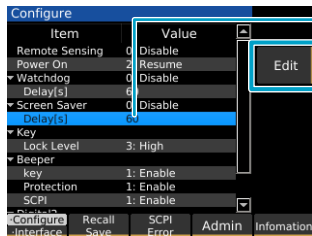

Pressing Edit or a numeric key makes it possible to edit the value.

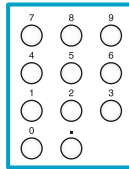

When changing a setting, if there are multiple items you can choose from, select a number in front of the item name using the numeric keypad, or select the item using the rotary knob. Procedures using the rotary knob are provided in this document.

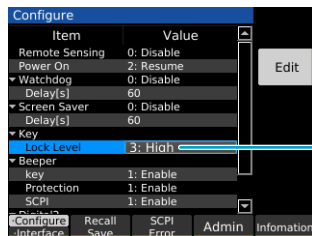

If there are multiple items when settings are being changed, use the numeric keypad or the rotary knob to select the item.

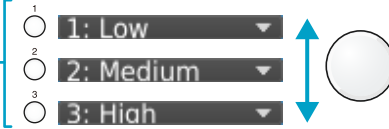

To confirm a value you entered, press the Edit or ENTER key. Procedures using the ENTER key are provided in this document.

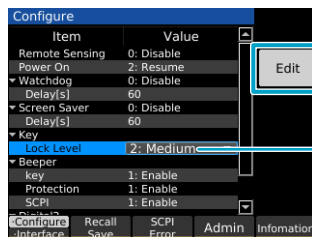

Use Edit or ENTER to confirm the value.



Load On/Off

“Load on” refers to a condition in which a current is running through the PLZ-5W. “Turning the load on” refers to the operation of running a current through the PLZ-5W.

Conversely, “load off” refers to a condition in which a current is not running through the PLZ-5W. “Turning the load off” refers to the operation of stopping a current from running through the PLZ-5W.

Turning the PLZ-5W’s load on and off is done with the LOAD key.

1 Press LOAD.

The value switches between load on and load off each time you press the key.

In the load on state, the load on LED lights.

In the load off state, the load on LED turns off.

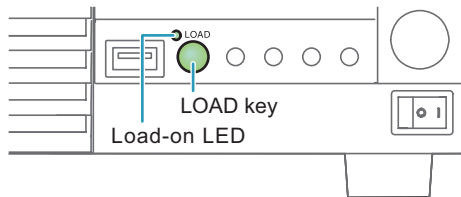

■ Controlling load on/load off externally

Load on/load off can be controlled using an external signal ([p.98](#)).

■ Gradually increasing the input current of the PLZ-5W

In constant current (CC) mode, you can set to slowly increase the input current (Soft start) ([p.55](#)).

■ Turning off the load after a specified time elapses

When performing battery or capacitor discharge tests, it is convenient to use the function to automatically turn off the load after a specified time elapses (auto load off timer) ([p.58](#)).

Setting the Operation Mode

The PLZ-5W has the following five operation modes. Mode switching can be done only while the load is off.

| | |
|------------------------------------------|----------------------------------------------------------------------------------------------------------------------------------------|
| Constant current (CC) mode | A current value is specified and the current is kept constant even when the voltage changes. |
| Constant resistance (CR) mode | A conductance value is specified and the PLZ-5W sinks current proportional to the voltage variation. |
| Constant voltage (CV) mode | A voltage is specified and the PLZ-5W sinks current so that the voltage at the load input end of the PLZ-5W is constant. |
| Constant power (CP) mode | A voltage is specified and the PLZ-5W sinks current so that the power consumed inside the electronic load is constant. |
| Arbitrary I-V Characteristics (ARB) Mode | The desired load characteristics can be set by specifying multiple arbitrary voltage values and current values as I-V characteristics. |

CV mode can be added to CC mode (CC+CV) and CV to CR mode (CR+CV).

Setting the operation mode

You can set +CV regardless of whether the load is on or off. You can set other modes only when the load is off.

1 Press SOURCE and then Mode.

The operation mode is shown in the sub-function area.

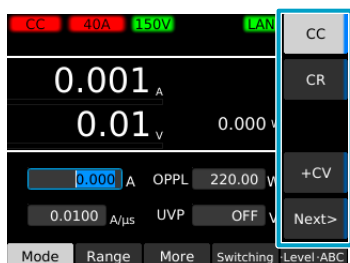

2 Use the sub-function keys to select the operation mode.

To set CC+CV, select CC and +CV.

To set CR+CV, select CR and +CV.

If the operation mode you want to select is not shown, press Next or Back to switch the operation mode display.

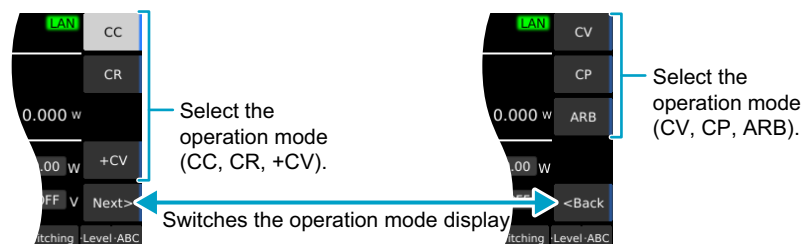

“CC,” “CR,” “CV,” “CP,” “CC+CV,” “CR+CV,” or “ARB” appears in the upper left of the display depending on the selected operation mode.

This completes the setting.

Setting the current in CC mode

In CC mode, the current is kept constant even when the voltage changes.

For details on CC mode, see “Operation of the constant current (CC) mode” (p.148).

1 Set the operation mode to CC mode (p.25).

2 Press Level and then Current.

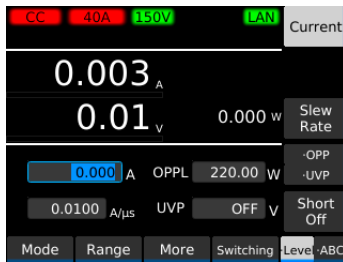

3 Use the numeric keypad or the rotary knob to enter the current value.

This completes the setting. The current value can be changed even while the load is turned on.

Setting the conductance in CR mode

In CR mode, the PLZ-5W sinks current proportional to the voltage variation. The resistance calculated from the conductance can also be displayed. (Conductance [S] = 1/resistance [Ω])

For details on CR mode, see “Operation in constant resistance (CR) mode” (p.149).

1 Set the operation mode to CR mode (p.25).

2 Press Level and then Conductance.

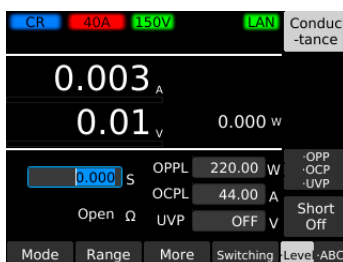

3 Use the numeric keypad or the rotary knob to enter the conductance value.

This completes the setting. The conductance value can be changed even while the load is turned on.

Setting the voltage in CV mode

In CV mode, the PLZ-5W runs current so that the voltage at the load input end of the PLZ-5W is constant. For details on CV mode, see “Constant voltage (CV) mode operation” (p.152).

- 1 Set the operation mode to CV mode (p.25).
- 2 Press Level and then Voltage.



- 3 Use the numeric keypad or the rotary knob to enter the voltage value.
This completes the setting. The voltage value can be changed even while the load is turned on.

Setting the power in CP mode

In CP mode, the PLZ-5W runs current so that the consumed power is constant. For details on CP mode, see “Constant power (CP) mode operation” (p.151).

- 1 Set the operation mode to CP mode (p.25).
- 2 Press Level and then Power.



- 3 Use the numeric keypad or the rotary knob to enter the power value.
This completes the setting. The power value can be changed even while the load is turned on.

Setting the load value in CC+CV mode

You can add CV mode in CC mode.

For details on CC+CV mode, see “Operation when CV mode is added to CC mode” (p.154).

1 Set the operation mode to CC+CV mode (p.25).

2 Press Level and then Voltage.



3 Use the numeric keypad or the rotary knob to enter the voltage value.

This sets the voltage value.

4 Press Current.



5 Use the numeric keypad or the rotary knob to enter the current value.

This sets the current value. The voltage and current values can be changed even while the load is turned on.

This completes the setting.

Setting the load value in CR+CV mode

You can add CV mode in CR mode. CV mode can be added even while the load is turned on.
For details on CR+CV mode, see “Operation when CV mode is added to CR mode” (p.155).

1 Set the operation mode to CR+CV mode (p.25).

2 Press Level and then Voltage.



3 Use the numeric keypad or the rotary knob to enter the voltage value.

This sets the voltage value.

4 Press Conductance.



5 Use the numeric keypad or the rotary knob to enter the conductance value.

This sets the conductance value. The voltage and conductance values can be changed even while the load is turned on.

This completes the setting.

Setting the load value in ARB mode

In ARB mode, arbitrary I-V characteristics can be set by registering multiple I-V characteristic points (set of voltage value and current value). Three up to 100 points can be registered, and the space between two points is linearly interpolated. This mode can be used for simulation of LED loads and the like.

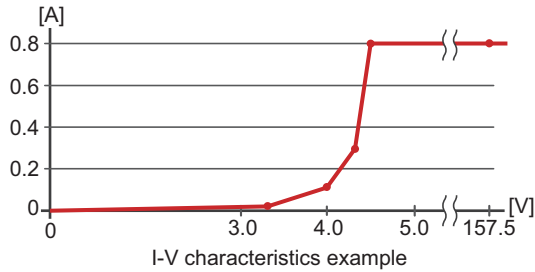

Example of settings (values with an asterisk are fixed)

| Voltage [V] | Current [A] |
|-------------|-------------|
| 0* | 0* |
| 3.2 | 0.02 |
| 4.0 | 0.1 |
| 4.3 | 0.3 |
| 4.5 | 0.8 |
| 157.5* | 0.8 |

Displaying the I-V characteristics editing screen

- 1 Set the operation mode to ARB mode (p.25).
- 2 Press Level and then Table.

The I-V characteristics editing screen appears.



Basic operations on the I-V characteristics editing screen

The left column is voltage, and the right is current. In each row, you can enter a single point of your choice.

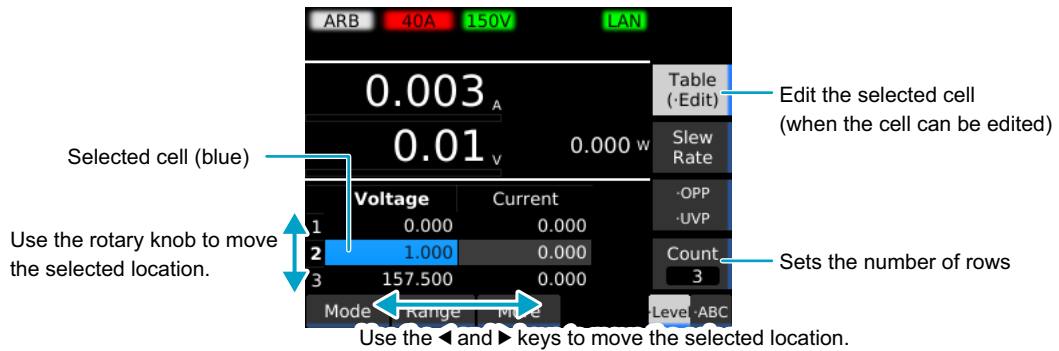

■ Setting the number of rows

You can change the number of rows using the Count key.

If you increase the number of rows, a copy of the selected row is inserted after the selected row.

If you decrease the number of rows to a number less than the number of the selected row, the last rows excluding the very last row are deleted. If you decrease the number of rows to a number greater than the number of the selected row, the selected row and subsequent rows are deleted.

Ex: Selecting row 3 and changing Count from 5 to 7

| | Voltage | Current |
|---|---------|---------|
| 1 | 0.000 | 0.000 |
| 2 | 1.000 | 0.100 |
| 3 | 2.000 | 0.200 |
| 4 | 3.000 | 0.300 |
| 5 | 157.5 | 0.400 |

← Two rows are inserted with the copy of row 3.

Selecting row 4 and changing Count from 7 to 3

| | Voltage | Current |
|---|---------|---------|
| 1 | 0.000 | 0.000 |
| 2 | 1.000 | 0.100 |
| 3 | 2.000 | 0.200 |
| 4 | 3.000 | 0.300 |
| 5 | 4.000 | 0.400 |
| 6 | 5.000 | 0.500 |
| 7 | 157.5 | 0.600 |

Deleted

Selecting row 4 and changing Count from 7 to 5

| | Voltage | Current |
|---|---------|---------|
| 1 | 0.000 | 0.000 |
| 2 | 1.000 | 0.100 |
| 3 | 2.000 | 0.200 |
| 4 | 3.000 | 0.300 |
| 5 | 4.000 | 0.400 |
| 6 | 5.000 | 0.500 |
| 7 | 157.5 | 0.600 |

Deleted

- 1 Press Count.
- 2 Use the numeric keypad or the rotary knob to enter the number of rows, and then press ENTER.

This completes the setting.

■ Setting the frequency

The voltage (0 V) and current (0 A) in the first row and the voltage (157.5 V) in the last row are fixed. You cannot enter a voltage that is less than the previous row or a voltage that is greater than the next row.

- 1 Select a value with the rotary knob and </> keys.
- 2 Press Table (*Edit).
- 3 Use the numeric keypad or the rotary knob to enter a value, and then press ENTER.

This completes the setting.

Example: Setting I-V characteristics

You can smoothly set the I-V characteristics by first setting the number of rows and then setting the row with the maximum voltage and proceeding to rows with lower voltages. As an example, let's set the I-V characteristics while referring to the table below.

Example of settings (values with an asterisk are fixed)

| Voltage [V] | Current [A] |
|-------------|-------------|
| 0* | 0* |
| 3.2 | 0.02 |
| 4.0 | 0.1 |
| 4.3 | 0.3 |
| 4.5 | 0.8 |
| 157.5* | 0.8 |



1 Press Level and then Table.
The I-V characteristics editing screen appears.

2 Press Count.

3 Use the numeric keypad or the rotary knob to enter the number of rows "6", and then press ENTER.

The rows are added.

4 Use the rotary knob and the ► key to select the Current column of row 6.

5 Press Table (•Edit).

The current value in row 6 becomes editable.



6 Use the numeric keypad or the rotary knob to enter the current value "0.8", and then press ENTER.

The current value in row 6 is set to 0.8 A.

7 Use the rotary knob and the ◀ key to select the Voltage column of the row 5.

8 Press Table (•Edit).

The voltage value in row 5 becomes editable.



9 Use the numeric keypad or the rotary knob to enter the voltage value "4.5", and then press ENTER.

The voltage value in row 5 is set to 4.5 V.

10 Use the ► key to select the Current column of row 5.

11 Press Table (•Edit).

The current value in row 5 becomes editable.

| | Voltage | Current | OPP |
|---|---------|---------|-----|
| 4 | 0.000 | 0.000 | UVP |
| 5 | 4.500 | 0.800 | |
| 6 | 157.500 | 0.800 | |

12 Use the numeric keypad or the rotary knob to enter the current value “0.8”, and then press ENTER.

The current value in row 5 is set to 0.8 A.

| | Voltage | Current | OPP |
|---|---------|---------|-----|
| 2 | 3.200 | 0.020 | UVP |
| 3 | 4.000 | 0.100 | |
| 4 | 4.300 | 0.300 | |

13 In the same manner, set the voltage and current values in rows 4 through 2.

This completes the setting.

Setting the Current Range and Voltage Range

The current range and voltage range can be set when the load is off. The current range that can be specified varies depending on the model.

- 1 Press **SOURCE** and then **Range**.
- 2 Use the sub-function keys to set the current range and the voltage range.

The set range is displayed by a range icon at the top of the screen.

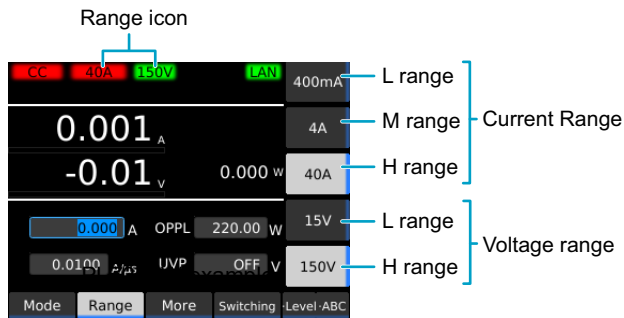

This completes the setting.

NOTE

If the current range is changed to other than H range using external control, an asterisk will appear on the current range icon. Example: **4A***

Setting the Slew Rate

You can set the speed of change when the current is changed.

The slew rate functions in the following cases.

- When the setting is changed to change the current value (including the switching function).
- When the current value is changed using external control in constant current (CC) mode.
- When the current value is changed while the load is on

The slew rate is set according to the current range as an amount of current change per unit of time. The value is common to rising and falling slopes.

NOTE

- The specified slew rate may not be achieved depending on the load cable inductance. If this happens, reduce the load cable inductance ([p.143](#)).
- If the load current is small, the specified slew rate may not be achieved ([p.146](#)).
- If the current changes when the load is turned on, the slew rate may be slower than the setting.

You can set this regardless of whether the load is on or off. This function operates in CC and ARB modes.

1 Press SOURCE, Level, and then Slew Rate.



2 Use the numeric keypad or the rotary knob to enter the slew rate value.

This completes the setting.

Setting the Short Function

The load input terminals can be shorted artificially by activating the short function. In constant current (CC) mode, the maximum current value, and in constant resistance (CR) mode, the minimum voltage value, is set, and the relay contact (30 Vdc/1 A) of the EXT CONT connector (p.92) closes.

The load input terminals can be shorted by driving an external high-current relay or the like.

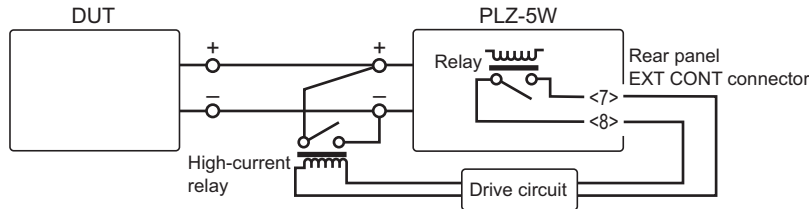

NOTE

Be sure to use a dedicated driver circuit to drive the high-current relay. Please provide your own dedicated driver circuit.

This function operates in CC and CR modes.

- 1** Press **SOURCE** and then **Level**.
- 2** In **CC** mode, press **Current**, and in **CR** mode, press **Conductance**.
- 3** Press **Short**.

The current setting shows “Short,” and the short function is enabled.

The short function switches on and off each time you press the key.

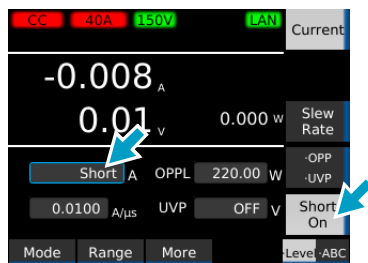

This completes the setting.

Switching Function

Switching refers to the operation of executing two settings repetitively. The switching function is suitable for transient response characteristics testing of regulated DC power supplies.

When the switching operation is in progress, a trigger signal is output from the TRIG OUT connector on the front panel (p.39).

You can set this regardless of whether the load is on or off. This function operates in CC and CR modes.

Setting the switching level

The switching level is set with a value or a percentage of the load value.

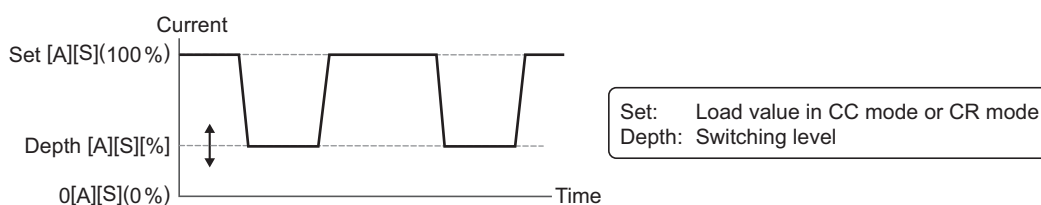

1 Press SOURCE, Switching and then Depth.

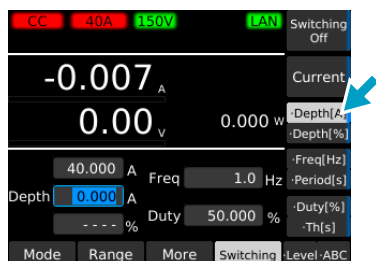

2 Use the numeric keypad or rotary knob to enter the switching level (Depth).

Enter a value (a current [A] in CC mode or a conductance [S] in CR mode) or a percentage of the load value. The input switches between numeric input and percentage [%] input every time you press Depth.

This completes the setting.

Setting the switching interval

Set the switching interval using the length of time at the high level or the duty ratio (ratio of high level to one cycle) for the frequency or cycle.

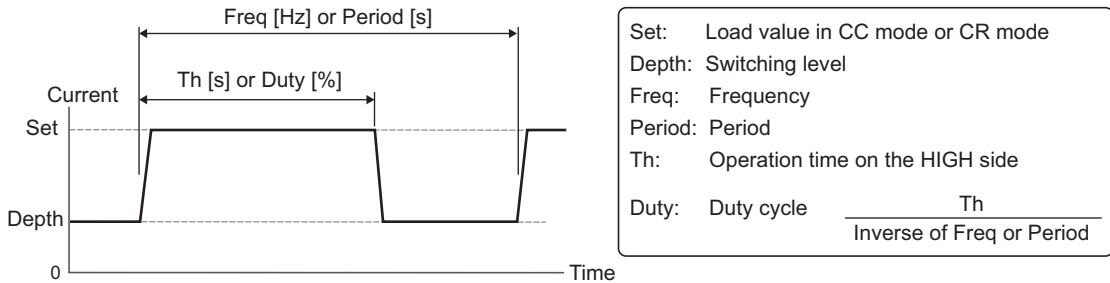

1 Press SOURCE, Switching and then Freq or Period.

The input switches between frequency [Hz] input and cycle [s] input every time you press the key.



2 Use the rotary knob to enter the frequency or cycle.

You can enter the frequency also using the numeric keypad.

3 Press Duty or Th.

The input switches between duty ratio [%] input and high level time [s] input every time you press the key.

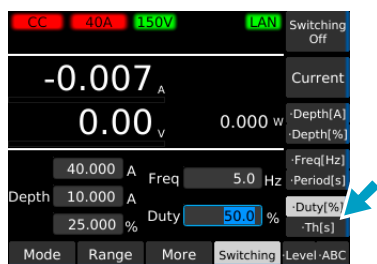

4 Use the rotary knob to enter the duty ratio or high level time.

You can enter the duty ratio also using the numeric keypad. The minimum switching interval is 5 μs. The minimum changeable digit of high level time varies depending on the frequency.

This completes the setting.

Turning the switching function on/off

If you want to turn on the switching function, set the switching level (p.37) and switching interval (p.38) in advance.

1 Press **SOURCE** and then **Switching**.

2 Press **Switching On** or **Switching Off**.

The switching function switches on and off each time you press the key.

When the switching function is on,  is shown on the display.

The current setting is shown in the sub-function area.



Timing of trigger signal output

When the switching operation is in progress, a trigger signal is output for 1 μ s from the TRIG OUT connector on the front panel when the current changes from low to high level.

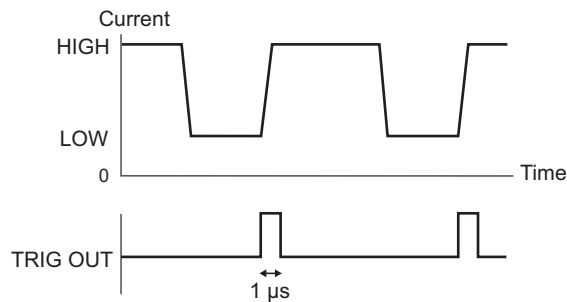

Alarm Function

This function detects anomalies and protects the DUT.

Alarm types and operation

There are two types of alarm based on urgency level: alarm 1 (high urgency) and alarm 2 (low urgency).

Alarm 1 (high urgency)

This alarm detects anomalies and automatically turns off the load. The operating conditions of this alarm are fixed. When alarm 1 occurs, immediately remove the cause(s) of the alarm.

| Name | Display | Operating condition | When activated |
|--------------------------------------------------------|--------------------|-----------------------------------------------------------------------------------------------------------------------------------------|----------------|
| Overvoltage detection | OVP Alarm | Voltage that is equal to or exceeds 110 % of the maximum voltage of the range is applied to the load input terminals. | Load off |
| Reverse-connection detection | Reverse Alarm | A reverse voltage (-0.6 V) is applied to the load input terminals. Or, a reverse current (approx. -1 % of the range rating) is flowing. | Load off |
| Overheat detection* ¹ | OTP Alarm | The temperature of the internal devices exceeds the standard. | Load off |
| Alarm input detection* ² | External Alarm | A signal between 1.5 V and 0 V is applied to ALARM INPUT (pin No. 6) of the EXT CONT connector. | Load off |
| Front-panel load input terminal over-current detection | Front Alarm | A current of 80 A or higher is flowing through the front panel load input terminals. | Load off |
| Parallel operation anomaly detection | See the reference. | An anomaly occurred during parallel operation (p.109). | Load off |

*1. Check whether the air inlet on the front panel and the air outlet on the rear panel are being obstructed.

*2. First clear the signal input to the EXT CONT connector, then clear the alarm of the PLZ-5W.

Alarm 2 (low urgency)

This alarm protects the DUT. The operating conditions of this alarm can be set freely within a given range.

| Name | Display | Operating condition | When activated |
|---------------------------------------------|----------------|------------------------------------------------------------------------------------------------------------------------------|---------------------------|
| Overcurrent protection (OCP) | OCP Alarm | Current at or exceeding the OCP setting (0 % to 110 % of rated current) flows (p.42). | Select load off or limit. |
| Overpower protection (OPP) | OPP Alarm | Power at or exceeding the OPP setting (0 % to 110 % of rated current) is applied (p.43). | Select load off or limit. |
| Undervoltage protection (UVP)* ¹ | UVP Alarm | The voltage becomes equal to or less than the UVP setting (0 V to 150 V) (p.44). | Load off |
| Watchdog Protection (WDP) | Watchdog Alarm | SCPI communication is not performed for a length of time that is equal to or exceeds the watchdog protection setting (p.45). | Load off |

*1. UVP can be set to off.

Operating range

The operating range of the alarms is linked to the current and the voltage ranges. For details on the operating area of each operation mode, see "Operating Area" (p.147).

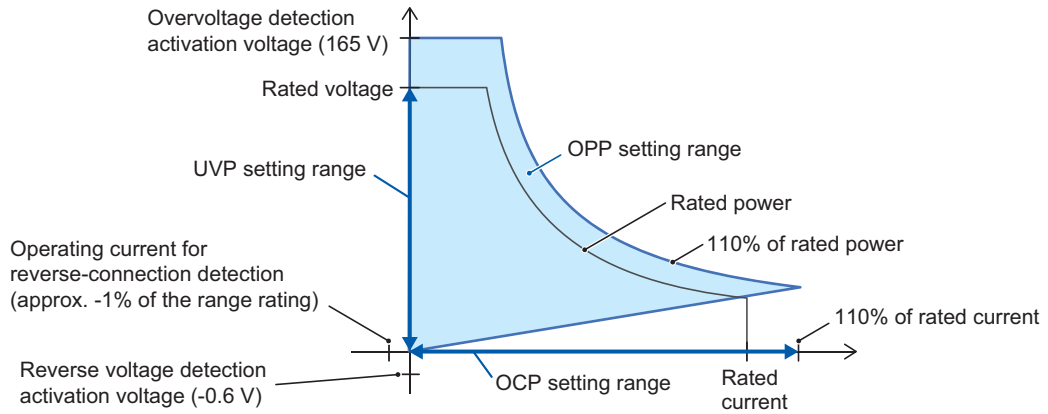

NOTE

- The detection points of OCP, OPP, and UVP are the load input terminals of the PLZ-5W. However, when the remote sensing function (p.56) is used, the detection points are the connection points (sensing points).
- The detection points for overvoltage detection and reverse-connection detection are the load input terminals of the PLZ-5W.

Setting overcurrent protection (OCP)

This function either puts a limit on the current (OCPL) or turns off the load of the PLZ-5W (OCPT) when a current that is equal to or exceeds the set value is running through the PLZ-5W. You can set the overcurrent protection setting and the operation when an alarm occurs.

If the OCP value is set to 110 % of the L range rating or M range rating, an alarm occurs at a current 110 % of each range's rating.

You can set this function when the load is off. This function operates in CR, CV, and CP modes.

1 Press Source and then Level.

2 Press OCP repeatedly until OCP is selected.

Each time you press the key, the selected item changes.



3 Use the numeric keypad or the rotary knob to enter the current value.

4 Press Action and select the operation when an alarm occurs.



Each time you press the key, the item changes.

| Item | Description |
|-------|----------------------------------------------------------------------------------------------|
| Trip | Turns the load off. The setting display changes to "OCPT". |
| Limit | Limits the current so as not to exceed the set value. The setting display changes to "OCPL". |

This completes the setting.

Setting overpower protection (OPP)

This function either puts a limit on the power (OPPL) or turns off the load of the PLZ-5W (OPPT) when a current that is equal to or exceeds the set value is applied to the PLZ-5W. You can set the overpower protection setting and the operation when an alarm occurs.

If the OPP value is set to 110 % of the L range rating or M range rating, an alarm occurs at a power 110 % of each range's rating.

You can set this function when the load is off. This function operates in modes other than CP mode.

1 Press Source and then Level.

2 Press OPP to select OPP.

Each time you press the key, the selected item changes.



3 Use the numeric keypad or the rotary knob to enter the power value.

4 Press Action and select the operation when an alarm occurs.



Each time you press the key, the item changes.

| Item | Description |
|-------|--------------------------------------------------------------------------------------------|
| Trip | Turns the load off. The setting display changes to "OPPT". |
| Limit | Limits the power so as not to exceed the set value. The setting display changes to "OPPL". |

This completes the setting.

Setting undervoltage protection (UVP)

This function turns off the load of the PLZ-5W when the voltage applied to the PLZ-5W becomes equal to or less than the UVP setting. You can also turn UVP off.

You can set this function when the load is off. This function operates in modes other than CV mode.

1 Press Source and then Level.

2 Press UVP to select UVP.

Each time you press the key, the selected item changes.

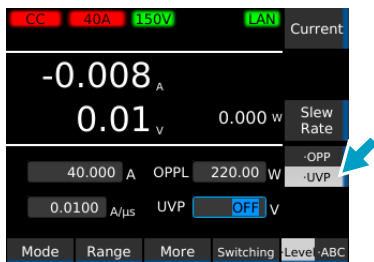

3 Use the numeric keypad or the rotary knob to enter the voltage value.

To turn this off, turn the rotary knob counterclockwise to select OFF.

This completes the setting.

Setting watchdog protection (WDP)

This function turns off the load of the PLZ-5W when SCPI communication is performed for a length of time that is equal to or exceeds the WDP setting.

1 Press SYSTEM.

The Configure screen appears.
If the Configure screen does not appear, press Configure.

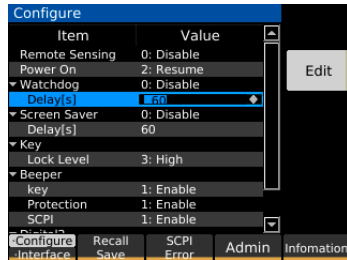

2 Use the rotary knob to select Delay under Watchdog, and then press Edit.

3 Use the numeric keypad or the rotary knob to enter the time [s], and then press ENTER.

This sets the WDP value.

4 Use the rotary knob to select Watchdog, and then press Edit.

5 Use the rotary knob to select Enable or Disable, and then press ENTER.

This completes the setting.

When an alarm occurs

An alarm message appears in the message area of the display.
Additionally, there are the following status outputs to the EXT CONT connector.

- When overvoltage detection, reverse-connection detection, overheat detection, alarm input detection, front-panel load terminal overcurrent detection, or parallel operation anomaly detection is activated: ALARM1 (pin 14) switches ON
- When OCP, OPP, UVP or WDP is activated: ALARM2 (pin 15) switches ON

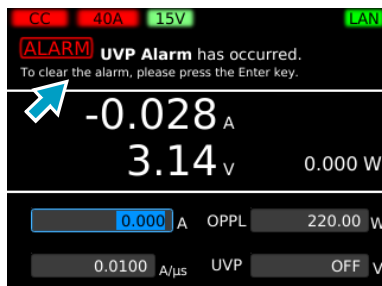

Example when UVP occurs

Clearing an alarm

1 Remove the cause of the alarm.

2 Press **ENTER**.
The alarm is cleared.

NOTE If the cause of the alarm remains, the alarm will occur again.

Recording Measurements

The PLZ-5W shows the latest measured values (current, voltage, power) on the display. It can also store them in the internal memory (data logging function). Recorded measurements are obtained by remote control.

By setting measurement recording conditions (p.48), you can control the timing that measurements are recorded.

The recording timing of measurements can be synchronized on synchronized PLZ-5Ws (p.70).

Starting measurement recording

1 Press MEASURE and then Acquire.

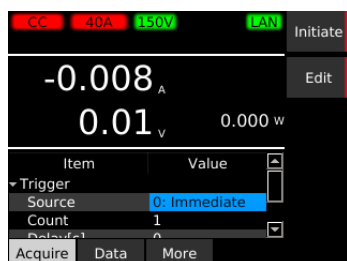

2 Press Initiate.

Measurement recording starts. While recording is in progress,  is displayed in the upper right of the display.

Obtaining measurements

Measurements are obtained by remote control. For details, see “Command (function search)” > “Measurement function” in the Communication Interface Manual on the included CD-ROM.

Setting recording conditions

You can set the following measurement recording conditions.

| Condition | Value | Description |
|----------------|---------------------|--------------------------------------------------------------------------------------------------------------------------------------------------------|
| Trigger | – | Set the measurement recording timing and the number of times to record measurements. |
| Source | – | Event (trigger source) that defines the measurement recording condition. Recording starts after the Initiate key is pressed and a trigger is received. |
| | Immediate | Pressing Initiate applies a trigger immediately. |
| | BUS | Applies a trigger when a *TRG command is received from a PC or when the *TRG key on the front panel is pressed. |
| | DIGITAL2*1 | Applies a trigger when a signal is received at pin 13 of the EXT CONT connector. |
| | MSync | The trigger application timing is synced between PLZ-5W that are synchronized (p.70). |
| | TALink | Applies a trigger when a step is executed if Generate is set to TA Link in the sequence step settings (p.80). |
| Count | 1 to 65536 | The number of times to recorded measurements. |
| Delay | 0 s to 100 s | The delay time from trigger application until measurement recording. |
| Interval | Disable/Enable | Sets whether to insert an interval between recordings when Count is 2 or higher. |
| Interval Time | 0.0002 s to 3 600 s | Recording interval time when Interval is set to Enable. |
| Sense Aperture | 0.0002 s to 1 s | Time period of each recording. The average over the time period is recorded. |

*1. Only when Direction of Digital 2 is set to Input (p.115).

Recording condition setting examples

Example: Source is set to Immediate, Interval to Disable, and Count to 3.

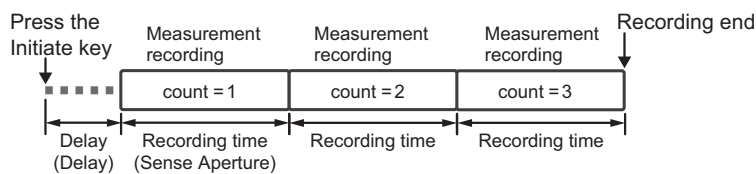

Example: Source is set to BUS, DIGITAL2, TALink, or MSync, Interval to Disable, and Count to 3.

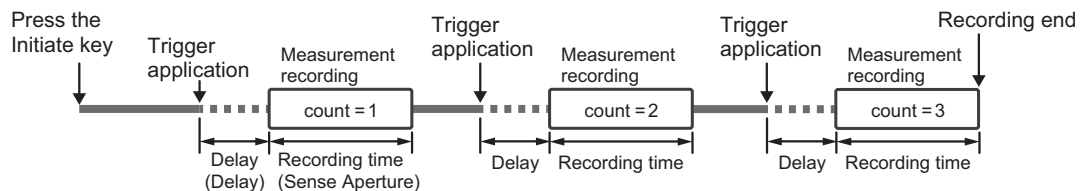

Example: Source is set to Immediate, Interval to Enable, and Count to 3.

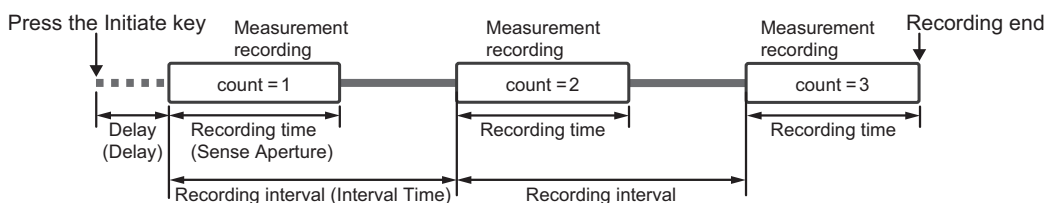

■ Measurement recording flowchart

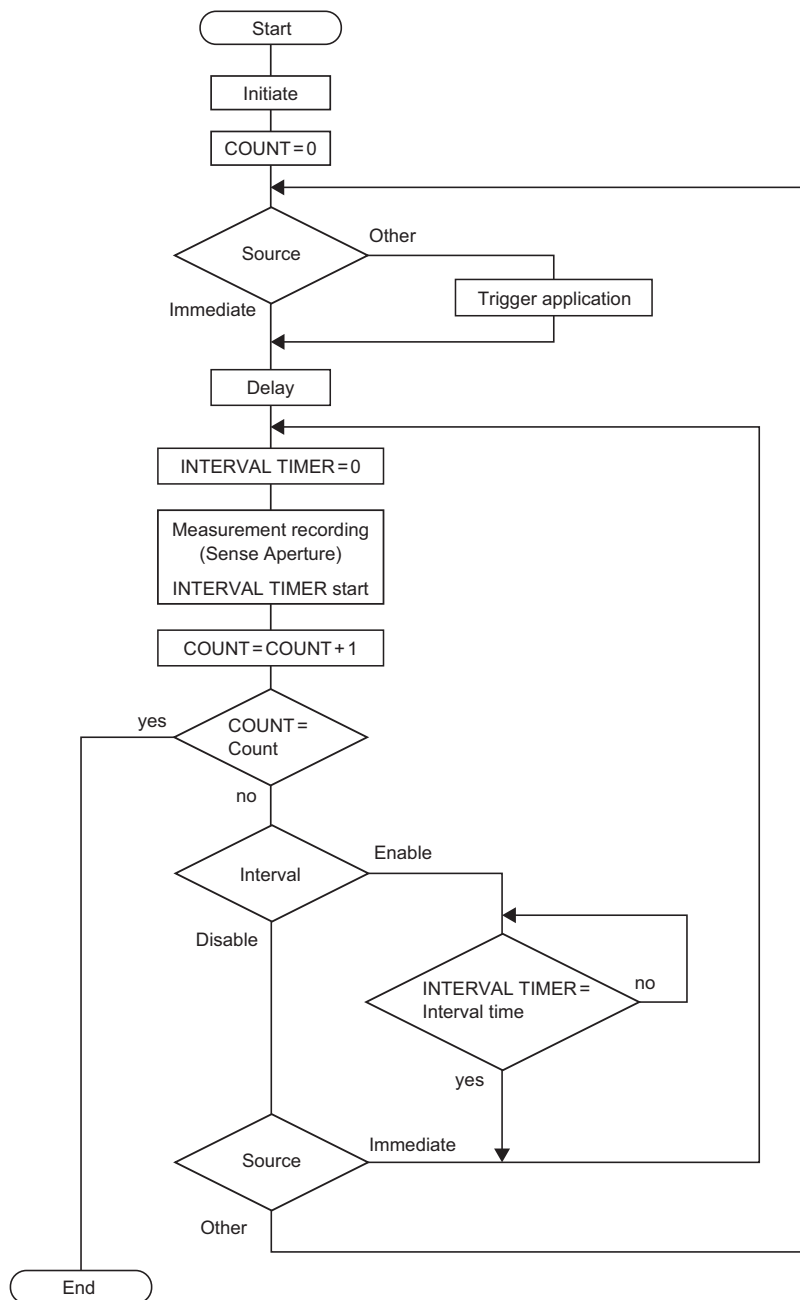

Setting recording conditions

- 1 Press MEASURE and then Acquire.
- 2 Use the rotary knob to select a measurement recording condition (p.48), and then press Edit.



- 3 Use the numeric keypad or the rotary knob to enter a value, and then press ENTER.
Repeat step 2 and step 3 to set the recording conditions.
This completes the setting.

Aborting a measurement recording

- 1 Press Abort while measurement is in progress.



Measurement recording is aborted.

Recording Integrated Data

Recording current capacity, power capacity, and elapsed time

Current capacity, power capacity, and elapsed time (hereafter referred to as integrated data) start/stop being recorded in synchronization with load on/off and are reset automatically at the start of recordings in the factory default condition.

You can set the recording period and the reset method of integrated data as follows.

| Item | Value | Description |
|---------------|-------------|----------------------------------------------------------------------------------------------------------------------------------------------------------------------------------------|
| Integral Gate | – | Sets the integrated data recording period. |
| | None | Recording is started/stopped with the Start key and Stop key. |
| | Load On | Recording is started/stopped in synchronization with load on/load off. |
| | Program Run | Recording is started/stopped in synchronization with sequence execution start/stop. |
| Reset | – | Selects the integrated data reset method. Integrated data will be reset regardless of the settings if the PLZ-5W is restarted, the operation mode is changed, or the range is changed. |
| | Manual | Integrated data is reset only when the Reset key is pressed. |
| | Auto | Integrated data is automatically reset before the start of recordings. |

Example: Integral Gate is set to Load On, and UVP is set

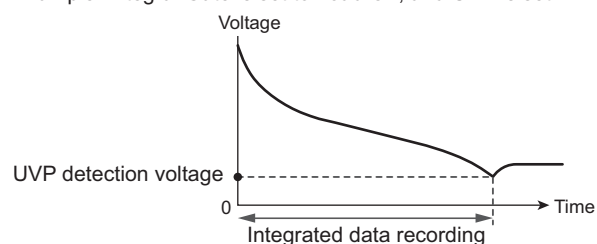

Setting the recording period and reset method of integrated data

- 1 Press MEASURE and then Data.
- 2 Use the rotary knob to select the item, and then press Edit.

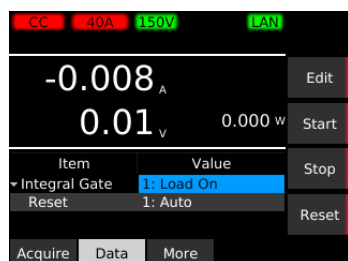

- 3 Use the rotary knob to select the value, and then press ENTER.
Repeat step 2 and step 3 to set the recording period and reset method.
This completes the setting.

Recording integrated data manually

In the integrated data recording method, if Integral Gate is set to None, the integrated data can be recorded manually.

1 Press MEASURE and then Data.

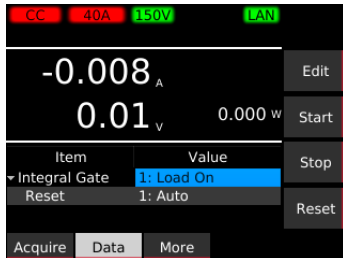

2 Press Start.

Integrated data recording starts.

3 Press Stop.

Integrated data recording stops.

Resetting integrated data

1 Press MEASURE and then Data.

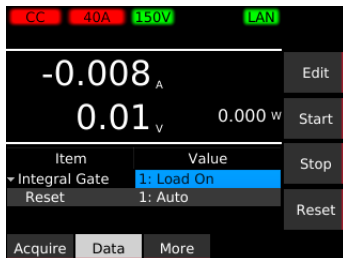

2 Press Reset.

This resets the integrated data.

Showing or hiding integrated data

You can show or hide integrated data. This is useful for example for battery discharge tests. By factory default, the integrated data is not shown.

- 1 Press **MEASURE** and then **More**.
- 2 Use the rotary knob to select the item, and then press **Edit**.



| Item | Description |
|--------------|----------------------------------|
| Elapsed Time | Shows the elapsed time. |
| Capacity | Shows the current capacity (Ah). |
| Energy | Shows the power capacity (Wh). |

- 3 Use the rotary knob to select **Enable (show)** or **disable (hide)**, and then press **ENTER**.

This completes the setting.

Advanced Functions

Changing the Response Speed

Set the response speed for the constant voltage (CV) mode or constant resistance (CR) mode according to the conditions and purpose of use of the DUT. The factory default setting is “Normal”. You can make the response speed faster by setting “Fast”.

NOTE

When the response speed is set to Fast, the operation may become unstable if the load cable is long or has a large loop. In that case, set the response speed to Normal.

- 1 Press **SOURCE** and then **More**.
- 2 Use the rotary knob to select the following items under **Response**, and then press **Edit**.

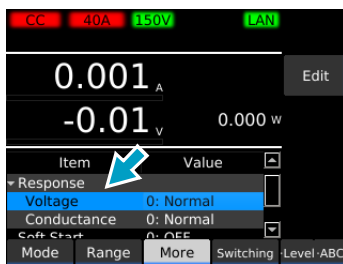

| Item | Description |
|-------------|------------------------------------|
| Voltage | Sets the response speed in CV mode |
| Conductance | Sets the response speed in CR mode |

- 3 Use the rotary knob to select **Normal** or **Fast**, and then press **ENTER**.

This completes the setting.

Soft Start

Soft start is a function that controls the rise time of the load current.

Soft start functions only when all the following conditions are met.

- The rise time of the soft start has been set.
- Load on state in constant current (CC) mode.
- There is an input that is equal to or exceeds the minimum operating condition, from the state where there is no input to the load input terminals.

This function is used if the output of the DUT becomes unstable when the load current rises sharply, or when wishing to delay only the current change at startup to prevent the overcurrent protection circuit of the power supply from getting activated.

■ When soft start has been disabled

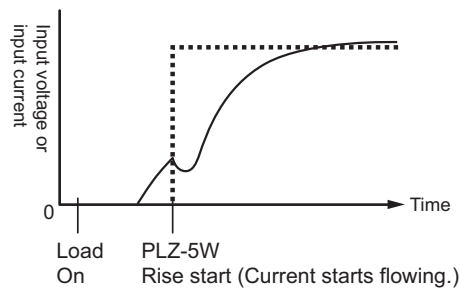

■ When soft start has been set properly

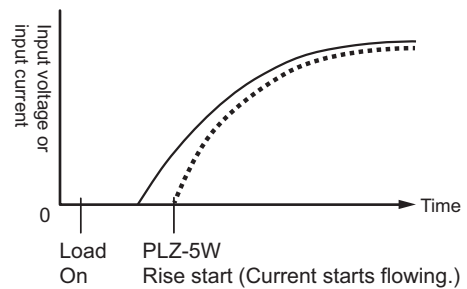

— DUT's voltage waveform
 PLZ-5W's current waveform

For the conditions for the current to flow through the PLZ-5W, see "Operating Area" (p.147).

- 1 Press **SOURCE** and then **More**.
- 2 Use the rotary knob to select **Soft Start**, and then press **Edit**.



- 3 Use the rotary knob to select the soft start time, and then press **ENTER**.
 Selecting Off disables soft start.
 This completes the setting.

Remote Sensing

You can change a voltage measurement point from a load input terminal to an arbitrary sensing point. By setting sensing points at the DUT end, influences such as voltage drops caused by the resistance of the load cables can be reduced, and the load current can be stabilized.

To use remote sensing, connect the sensing cables to the sensing terminals of the PLZ-5W and the DUT end, and enable the remote sensing function.

Connecting the sensing cables

⚠ CAUTION

- Risk of damage to the internal circuitry. Never wire the sensing terminals while the POWER switch is turned on.
- If the remote sensing cables come loose while remote sensing is in use, the PLZ-5W and DUT may be damaged. Be sure to connect the cables securely.

Unlike the load cables, there is no need to consider the current capacity for the sensing cables. However, for adequate mechanical strength, use wires whose nominal cross-sectional area is 0.5 mm² or greater.

- 1** Turn the POWER switch off.
- 2** Remove the sensing terminal cover on the rear panel.

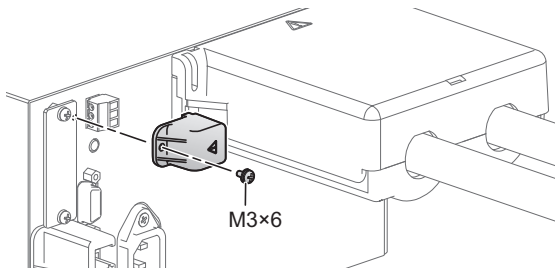

- 3** Connect the sensing cables to the PLZ-5W.

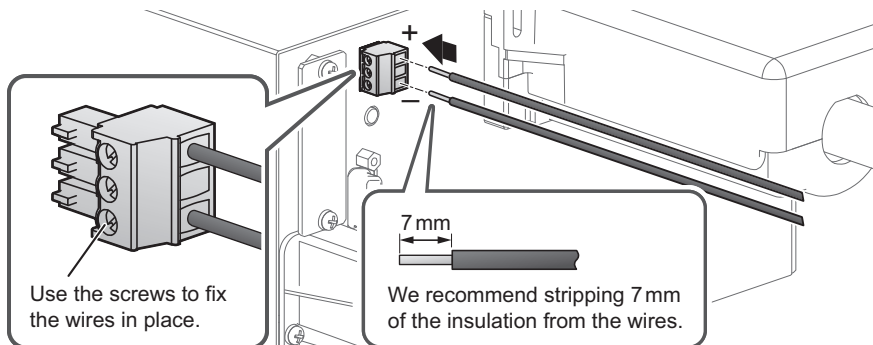

4 Attach the sensing terminal cover.

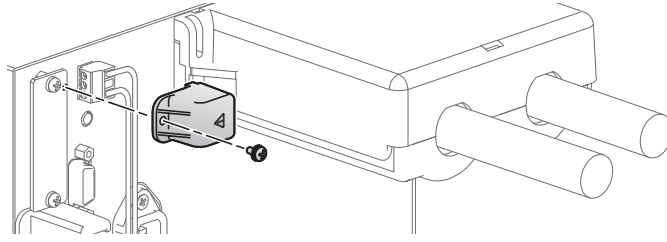

5 Connect the sensing cables to the DUT.

Connect the positive (+S) polarity of the SENSING connector to the positive (+) polarity of the DUT, and connect the negative (-S) polarity of the SENSING connector to the negative (-) polarity of the DUT. Connect the cables as close to the DUT as possible.

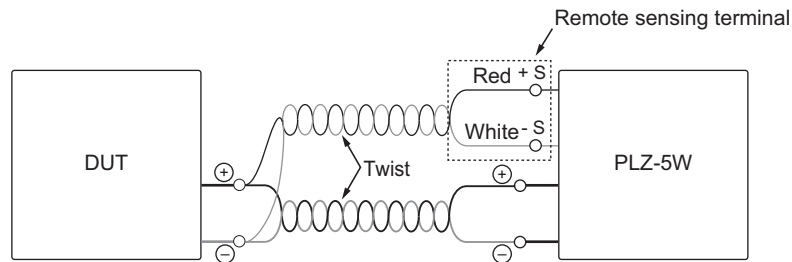

This completes the connections.

Enabling or disabling remote sensing

After connecting the sensing cables, enable remote sensing.

Remote sensing can be set when the load is turned off and sequence operation is stopped.

1 Press SYSTEM.

If the Configure screen does not appear, press Configure.

2 Use the rotary knob to select Remote Sensing, and then press Edit.

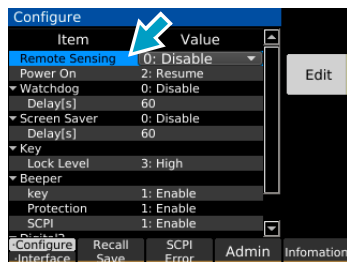

3 Use the rotary knob to select Enable or Disable, and then press ENTER.

If you select Enable,  appears in the upper right of the display.

This completes the setting.

Auto Load Off Timer

The auto load off timer automatically turns off the load after a specified time elapses from load on.

NOTE There is a ± 1 second error between the elapsed time recording (p.51) and elapsed time display (p.53).

- 1** Press **SOURCE** and then **More**.
- 2** Use the rotary knob to select **Load Off Timer**, and then press **Edit**.



- 3** Use the numeric keypad or the rotary knob to set the time (s) until load off, and press **ENTER**.

If you turn the rotary knob counterclockwise and select OFF, the auto load off timer is turned off. This completes the setting.

Types of Memory

The PLZ-5W has two types of memory, ABC preset memories and setup memory.

ABC preset memories are for storing three sets (A, B, and C) of load values. Because you can recall saved settings just by pressing a key, this feature is useful when you want to switch between the three sets of values in order.

Setup memory stores all basic settings.

■ Differences between ABC preset memories and setup memory

| Item | ABC Preset Memories | Setup Memory |
|--------------------------|----------------------------------------------------------------------------|------------------------------------------------------------------------------------------------------------------------------------------------------------------------------------------------------------------|
| Number of memory entries | 3 | 20 (internal memory) Depends on the memory size (USB memory) |
| Memory name | A, B, C | 0 to 19 (internal memory) Any name (USB memory) |
| Saved setting | Load values for each operation mode (current, voltage, conductance, power) | Operation mode Load values (current, voltage, conductance, power) Current range/voltage range Slew rate Switching level Switching interval Alarm 2 operating conditions ABC preset memories |
| When load is on | Memory entries can be saved or recalled. | Memory entries can be saved but not recalled |
| When load is off | Memory entries can be saved or recalled. | Memory entries can be saved or recalled. |

ABC Preset Memories

Load values can be saved in any of the three memories A, B, or C.

In CC mode, CR mode, CP mode, the load values for each current range can be saved.

In CV mode, the load values for each voltage range can be saved.

In ARB mode, the number of table rows and load values can be saved.

In CC+CV mode, values are saved in the CC mode and CV mode memories.

In CR+CV mode, values are saved in the CR mode and CV mode memories.

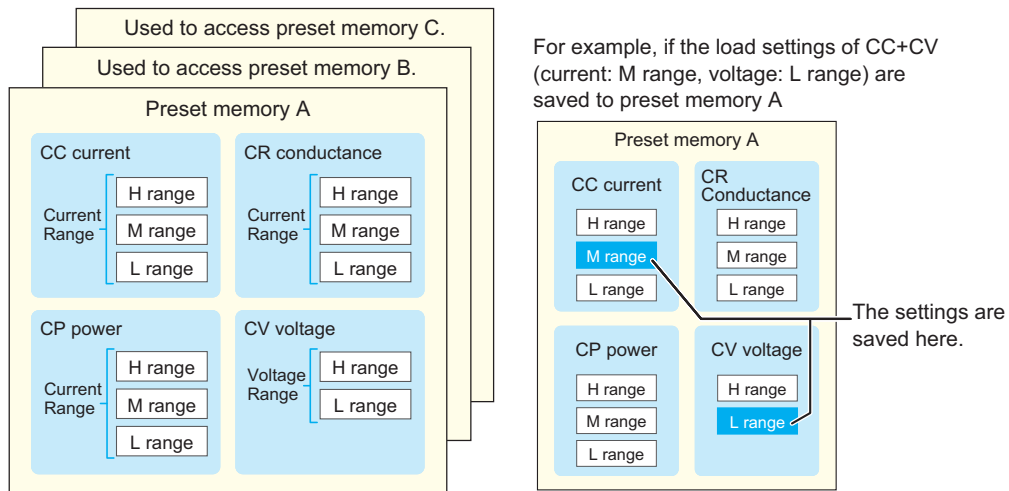

The load values for each operation mode saved to the memories are as follows.

| Operation mode | Load value |
|----------------|----------------------------------------|
| CC mode | Current |
| CR mode | Conductance |
| CP mode | Power |
| CV mode | Voltage |
| CC+CV | Current, voltage |
| CR+CV | Conductance, voltage |
| ARB mode | Number of table rows, voltage, current |

Saving to ABC preset memories

You can save settings regardless of whether the load is on or off. Alarm operating conditions are not saved.

1 Enter the load values for the operation mode and range to be saved.

2 Press ABC to select ABC.

Each time you press the key, the selected item changes.

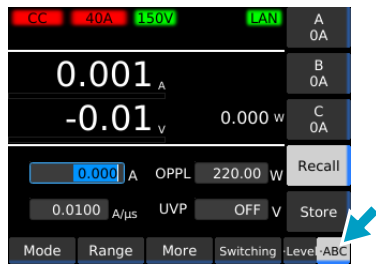

3 Press Store.

4 Press a sub-function keys to select the memory (A, B, C) you want to save to, and then press ENTER.

A confirmation screen appears.

5 Press ENTER.

The settings are saved to the selected memory.

If setting have already been saved, they are overwritten.



The saved load value is displayed (except ARB mode).

Example: CC mode, saved to memory A

Recalling ABC preset memory entries

You can recall settings regardless of whether the load is on or off.

If the settings that you recall cause alarm operating conditions to be exceeded, an alarm will occur.

NOTE

Alarm operating conditions are not saved to ABC preset memories.

1 Set the operation mode and range to the same settings as those in the memory you want to recall.

Memories cannot be recalled if the operation mode or range is different.

2 Press ABC to select ABC.

Each time you press the key, the selected item changes.



3 Press Recall.

4 Press the sub-function key (A, B, or C) for the memory to be recalled.

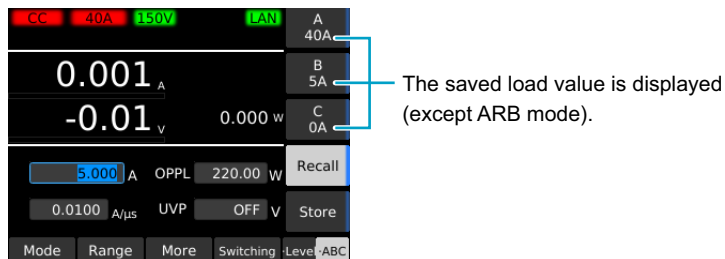

Example: CC mode

The preset memory is recalled.

Setup Memory

The setup memory can store up to 20 sets (0 to 19) of the current conditions of the items listed below. The current conditions can also be saved in a USB memory device.

- Operation mode
- Load values (current, conductance, voltage, power)
- Current range setting
- Voltage range setting
- Slew rate
- Switching level (current/conductance or percentage)
- Switching interval (frequency/time of one cycle and duty cycle/operating time on the high side)
- Alarm operating conditions
- Content of ABC preset memories

How to view the setup memory edit screen

Press SYSTEM and then Recall Save to display the setup memory edit screen. The internal memory contains an empty setup memory set. Connecting a USB memory device to the USB port on the front panel displays an "sdxx" folder (the "xx" changes depending on the USB memory device) enabling you to save and recall the setup memory from the USB memory device.

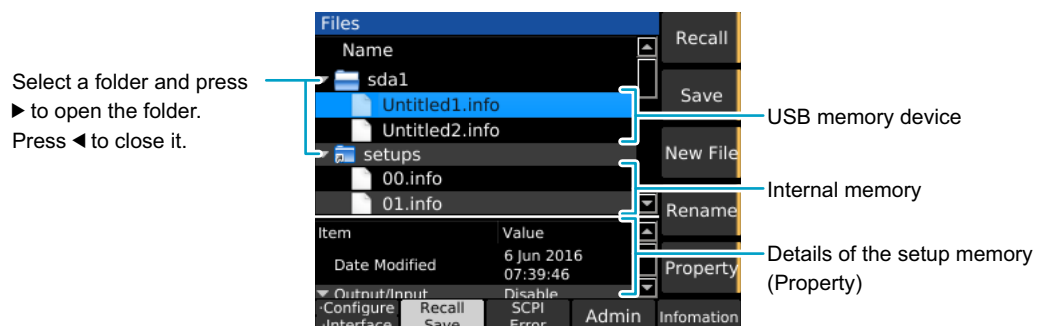

Saving to the setup memory

Saving over previous settings (internal memory and USB memory)

- 1** Set the operation mode, range, and settings to be saved.
- 2** Press **SYSTEM** and then Recall Save.

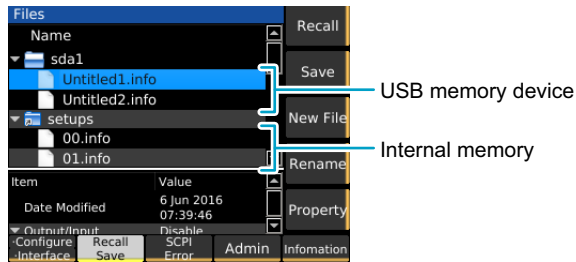

- 3** Use the rotary knob to select the setup memory.
- 4** Press **Save**.
The setting contents are saved to the setup memory.

Saving to a new file (USB memory device only)

- 1** Set the operation mode, range, and settings to be saved.
- 2** Press **SYSTEM** and then Recall Save.
- 3** Insert a USB memory device into the USB port on the front panel.
An “sdxx” folder is displayed. The “xx” changes depending on the USB memory device.
- 4** Use the rotary knob to select the sdxx folder, and press **New File**.
A new setup memory is created.

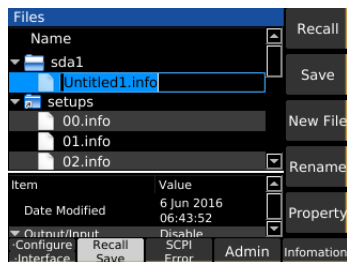

- 5** Use the numeric keypad or the rotary knob to enter a file name of your choice, and then press **ENTER**.
The setup memory is saved to a new file.

Changing the memory name (USB memory device only)

- 1** Press **SYSTEM** and then **Recall Save**.
- 2** Insert a **USB memory device** into the **USB port on the front panel**.
An “sdx” folder is displayed. The “xx” changes depending on the USB memory device.
- 3** Use the **rotary knob** to select the **setup memory**, and press **Rename**.

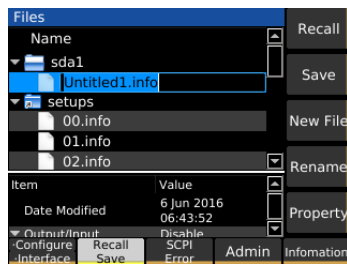

- 4** Use the **numeric keypad** or the **rotary knob** to enter a file name of your choice, and then press **ENTER**.
The memory name is saved.

Checking the setup memory details

- 1 Press **SYSTEM** and then **Recall Save**.
- 2 Use the rotary knob to select the setup memory.
- 3 Press **Property**.

The detailed information of the setup memory is displayed. The detailed information can be scrolled by using the rotary knob. Press **Property** again to return to the original state.

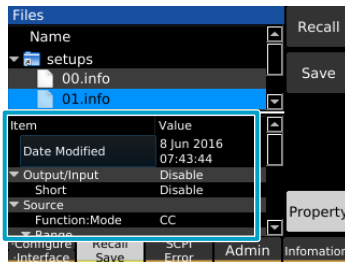

Recalling the setup memory

You can recall memory content when load is turned off.

- 1 Press **SYSTEM** and then **Recall Save**.
- 2 Use the rotary knob to select the setup memory.
Press **Property** to view the setting content of the setup memory.
- 3 Press **Recall**.

The setting content of the selected setup memory is recalled.

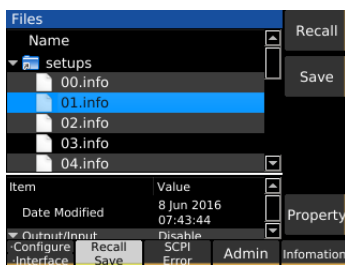

Synchronized Operation

If you interconnect the PLZ-5Ws with LAN cables, synchronized operation can be performed from any of the connected PLZ-5Ws.

- Synchronizing the load on/off operation
- Synchronizing measurement recording (remote control only)
- Synchronizing the starting and resuming of sequences

You can interconnect different PLZ-5W models (e.g., PLZ205W and PLZ1205W). Synchronized operation is possible even during parallel operation.

■ Simple setting using LAN cables

Common LAN cables (straight-through) up to 30m long can be used. If you need to use a LAN cable longer than 30 m, please contact your Kikusui agent or distributor.



WARNING

Risk of electric shock.

- Do not touch the IN/OUT connectors of EXT SYNC while the power is turned on.
- Do not leave one end of the LAN cable connected to the EXT SYNC port when the other end is not connected.

Connection for synchronized operation

- 1 Turn the **POWER** switches of all the **PLZ-5Ws** that you will connect.
- 2 Remove the **SYNC/PARALLEL** port cover.

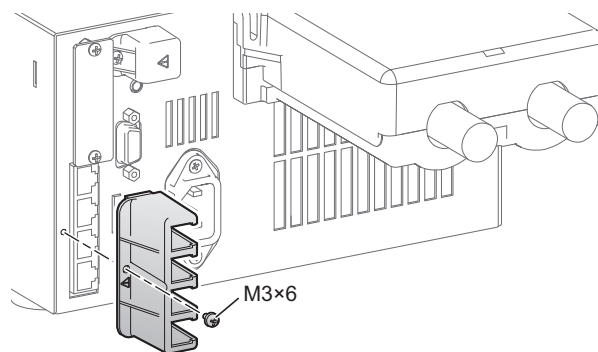

3 Connect all the PLZ-5Ws with LAN cables.

Connect the OUT port of EXT SYNC of a PLZ-5W to the IN port of EXT SYNC of another unit with a LAN cable.

Connection example

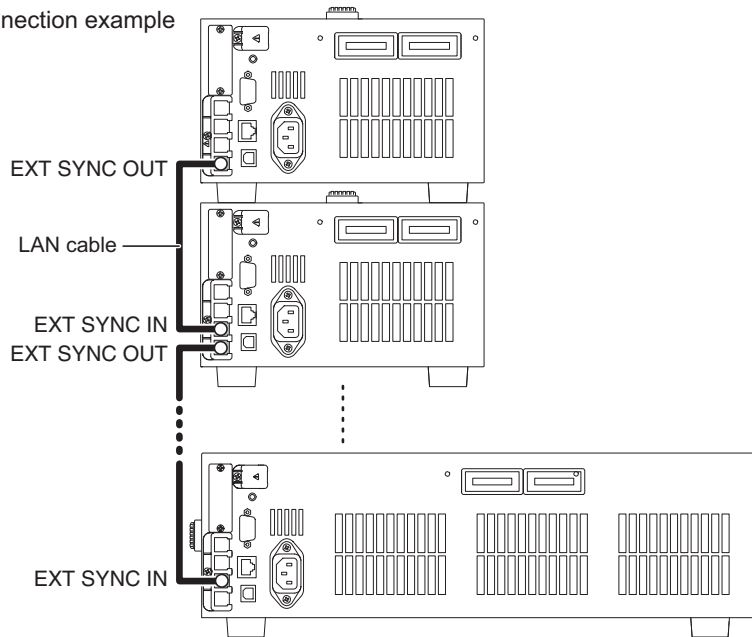

4 When you complete the connection, attach the SYNC/PARALLEL port cover.

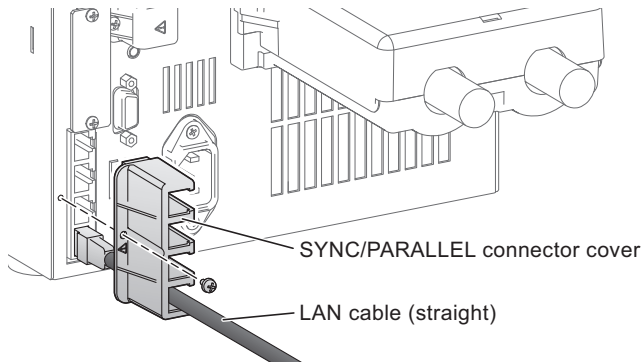

This completes the connections.

Synchronizing the load on/off operation

You can synchronize the load on/off operation on multiple synchronized PLZ-5Ws.

1 Press SOURCE and then More.

2 Press Sync Enable.

Load on/off synchronization switches between enabled and disabled each time you press the key. When load on/off synchronization is enabled, “Load On” and “Load Off” appear in the sub-function area.

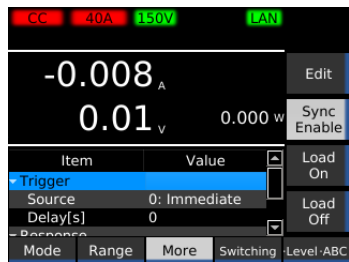

3 Perform step 1 and step 2 on all PLZ-5Ws to be synchronized.

4 Press Load On or Load Off on any of the synchronized PLZ-5Ws.

The load on/off operation will be synchronized among all PLZ-5Ws whose load on/off synchronization was enabled.

Synchronizing measurement recording

Measurement recording (p.47) can be synchronized among multiple synchronized PLZ-5Ws. To synchronize, you need to enter a command through remote control.

- 1 Press **MEASURE** and then **Acquire**.
- 2 Use the rotary knob to select **Source**, and then press **Edit**.
- 3 Use the rotary knob to select **MSync**, and then press **ENTER**.



- 4 Press **Initiate**.
- 5 Perform step 1 to step 4 on all PLZ-5Ws to be synchronized.
- 6 Apply **TRIG:ACQ:MSYN** commands to synchronized PLZ-5Ws through remote control.

Measurement starts simultaneously on all synchronized PLZ-5Ws.

For details, see "TRIG:ACQ:MSYN" in the Communication Interface Manual on the included CD-ROM.

Synchronizing the start of sequences

The start of sequences can be synchronized among multiple synchronized PLZ-5Ws. To synchronize, you first need to create a sequence (p.74).

- 1 Press **SOURCE** and then **More**.
- 2 Use the rotary knob to select **Source**, and then press **Edit**.
- 3 Use the rotary knob to select **MSync**, and then press **ENTER**.



- 4 Run the sequence (p.88).

The sequence pauses before executing the first step, and "MSync" appears in the sub-function area.



- 5 Perform step 1 to step 4 on all PLZ-5Ws to be synchronized.

- 6 Press **MSync** on any of the synchronized PLZ-5Ws.

Sequence starts simultaneously on all synchronized PLZ-5Ws.

Synchronizing the resuming of sequences

A sequence will stop at a step with Wait (pre) set to MSync (p.80).

The resuming of a paused sequence (trigger wait) can be synchronized on multiple synchronized PLZ-5Ws. To synchronize, you first need to create a sequence (p.74).

1 Press Sequence, Transient, and then Initiate on all PLZ-5Ws to be synchronized.

The sequence is executed.

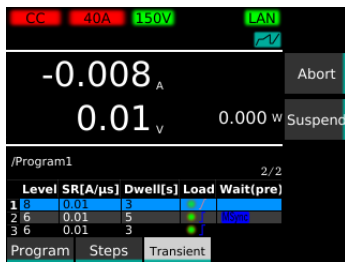

2 Wait for the sequence on all synchronized PLZ-5W to be paused.

The sequence pauses before executing a step with Wait (pre) set to MSync, and “MSync” appears in the sub-function area.



3 Press MSync on any of the synchronized PLZ-5Ws.

The sequence resumes simultaneously on all synchronized PLZ-5Ws.

Aborting synchronized operation

The synchronized operation setting is cleared when you remove the LAN cables.

Remote Control

In addition to using the front panel, you can also control the PLZ-5W remotely by sending commands.

For details on remote control, see the Communication Interface Manual on the included CD-ROM.

The following environment is required to view the Communication Interface Manual.

Browser: Internet Explorer or Google Chrome

PDF reader: Adobe Reader

Releasing remote control

You can return the PLZ-5W control from remote control (PLZ-5W panel control not accepted) to local control (panel control accepted). While remote control is in progress, the remote icon appears on the display.

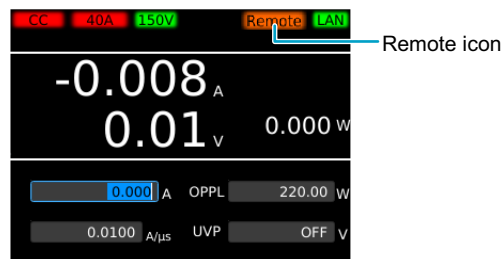

1 Press LOCAL.

This switches the operation from remote operation to local operation.

Sequence Function

Overview of the Sequence Function

Sequence is a function that executes a sequence of operations set in advance.

Programs and steps

A sequence consists of programs and steps. A program is a collection of steps. Steps are executed in order one at a time, starting from step 1. The completion of the last step signifies that the program has been executed once. When the specified number of program loops is completed, the sequence ends. The value at the end of the sequence will be the value of the last step.

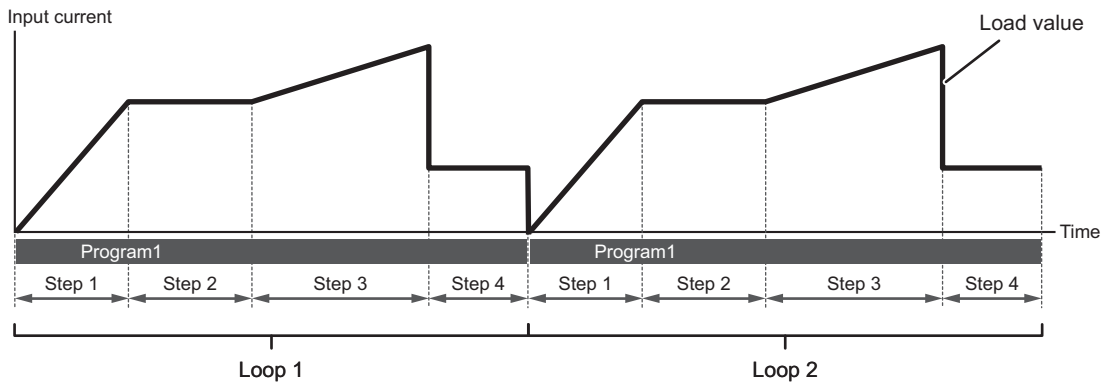

Set a program for each operation mode. Up to 30 programs can be set.
Up to 10000 steps total can be used in all programs

Main functions

| Setting range | Setting | Description |
|------------------|----------------------------|--------------------------------------------------------------------------------------------------------|
| By step | Load value | Current, conductance, voltage, power. The values that can be set depend on the current operation mode. |
| | Slew rate | Varies depending on the current range setting. |
| | Step execution time | 0.000025 s to 3600000 s |
| | Load on/off control | To turn the load on, set the load setting transition method to step or ramp. |
| | Miscellaneous | Trigger signal setting, trigger signal output |
| For each program | Number of loops of program | 1 to 100000 repetitions, or infinite repetitions. |
| | CV mode addition | Specifies the voltage for CV mode addition (+CV). |
| | Protection function | Specifies the value at which a protection function (OCP, OPP, UVP) is activated. |

Program Configuration

Different programs can be created for each operation mode (except ARB mode).

How to view the program editing screen

Press SEQUENCE and then Program to display the sequence editing screen.

When you change the operation mode (p.25), programs that were created in each operation mode are displayed.

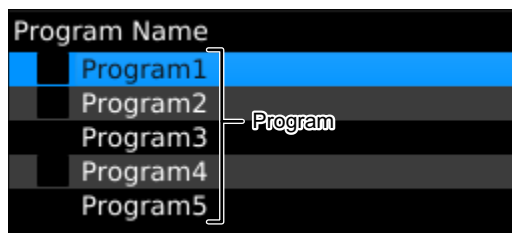

Example: Programs 1 to 5 have been registered

Creating a program

First, create an empty program without registering any steps.

Because the location where the program is created depends on the present operation mode, even if a program of the same name is created for example in CC mode and CP mode, the resulting programs will be treated as different programs.

The created program is automatically saved and is not deleted even if the POWER switch is turned off.

- 1 Set the operation mode (p.25).**
- 2 Press SEQUENCE and then Program.**
The program editing screen appears.
- 3 Press Create.**

If another program has a check mark (is selected), you cannot create a program. If this happens, press Select to remove the check mark.

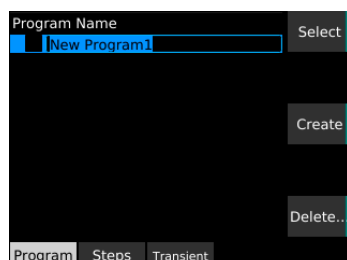

4 Use the numeric keypad or the rotary knob to enter the program name, and then press ENTER.

You can enter up to 255 characters for the program name. For information about registering steps to a program, see “Setting Steps” (p.80).

An empty program is created.

Setting the number of loops

1 Press SEQUENCE and then Program.

2 Use the rotary knob to select the program, and then press Select.

A check mark appears to the left of the selected program name.



3 Press Steps, Property, and then Loop.

4 Use the numeric keypad or the rotary knob to enter the number of loops, and then press Property.

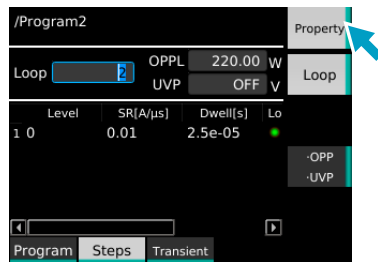

5 Press Save.

The number of loops is saved.

This completes the setting.

Setting the voltage of CV mode addition (+CV)

If the CV mode addition function is enabled (CC+CV or CR+CV) in operation mode, you can set the +CV voltage in the program.

- 1** Press **SEQUENCE** and then **Program**.
- 2** Use the rotary knob to select the program, and then press **Select**.
A check mark appears to the left of the selected program name.



- 3** Press **Steps**, **Property**, and then **Voltage**.
- 4** Use the numeric keypad or the rotary knob to enter the voltage value, and then press **Property**.

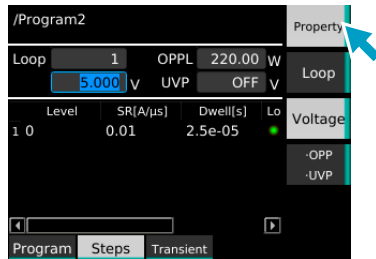

- 5** Press **Save**.
The +CV voltage is saved.
This completes the setting.

Setting protection functions

You can set overcurrent protection (OCP), overpower protection (OPP), and undervoltage protection (UVP) in a program. The protection functions that you can set varies depending on the operation mode.

1 Press SEQUENCE and then Program.

2 Use the rotary knob to select the program, and then press Select.

A check mark appears to the left of the selected program name.

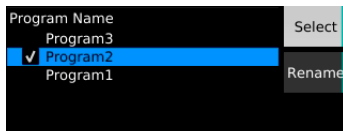

3 Press Steps, Property, and then OPP, OCP, or UVP.

The key names that appear vary depending on the operation mode. Each time you press the key, the item that you can set changes.

If you select OPP or OCP, you can select the operation (trip or limit) when an alarm occurs using the Action key.

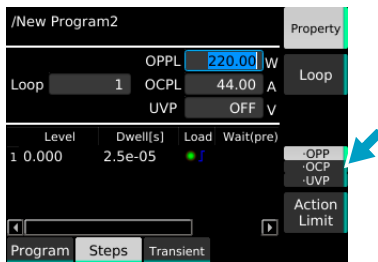

4 Use the numeric keypad or the rotary knob to enter the value, and then press Property.



5 Press Save.

The value is saved.

This completes the setting.

Changing a program name

- 1 Press **SEQUENCE** and then **Program**.
- 2 Use the rotary knob to select the program, and then press **Select**.
A check mark appears to the left of the selected program name.



- 3 Press **Rename**.
- 4 Use the numeric keypad or the rotary knob to enter the program name, and then press **ENTER**.
The program name is changed.

Deleting a program

- 1 Press **SEQUENCE** and then **Program**.
- 2 Use the rotary knob to select the program, and then press **Delete**.
If the check box of any program is selected, you cannot delete programs. If a check box is selected, use the rotary knob to select the corresponding program, and then press **Select** to clear the check box.

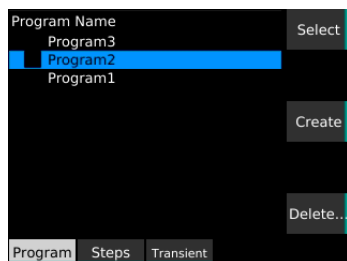

- 3 Use the rotary knob to select **OK**, and then press **ENTER**.
The program is deleted.

Setting Steps

Creating steps

- 1 Press SEQUENCE and then Program.**
- 2 Use the rotary knob to select the program, and then press Select.**
A check mark appears to the left of the selected program name.
- 3 Press Steps.**
The step editing screen appears.
If a new step editing screen is opened, the first step with the initial value is registered.

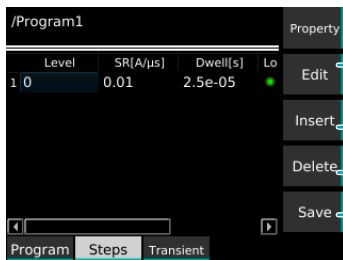

- ← Edit Enables the editing of the settings of the selected step. Or confirms the settings.
- ← Insert Adds a copy of the selected step below that step.
- ← Delete Deletes the selected step.
- ← Save Saves the edited step.

- 4 Use the rotary knob and the ◀/▶ keys to select a step and item, and then press Edit.**
- 5 Set the items.**
Item (p.81): Level, SR, Dwell, Load, Wait (pre), Wait (post), Generate, →
To confirm an item, press Edit again.
- 6 Repeat step 4 and step 5 until all the steps have been registered.**
- 7 Press Save.**
The steps are registered to the program.

Step settings

■ Level*1

Use the numeric keypad or the rotary knob to set the load value of each operation mode. The values that you can set varies depending on the current operation mode (A, SIE, V, W).

*1 This does not appear if the CC, CR, or CP external control is enabled in CC mode, CR mode, or CP mode (including CC+CV and CR+CV) or if the CV external control is enabled in CV mode (including CC+CV and CR+CV).

■ SR

Use the numeric keypad or the rotary knob to set the slew rate. The values that you can set varies depending on the current range setting (p.133).

■ Dwell

Use the numeric keypad or the rotary knob to set the step execution time. The values that you can set range from 0.000025 s to 3600000 s.

■ Load

Set the load state and the transition of the load value.

The load turns on and off each time you press the Load sub-function key. If set to load on, press Immediate or Ramp to select the transition method.

| Value | Description |
|-------------------|------------------------------------------------------------------------------------------------------------------------------------------------------------------------|
| Immediate (●) (I) | The load value transitions in steps from the value of the previous step. |
| Ramp (●) (R) | The load value transitions with a slope from the value of the previous step. If step 1 is set to ramp, the start point of the load value is always 0 A, 0 S, 0 V, 0 W. |

Example: Level: 10A, Dwell: 100ms

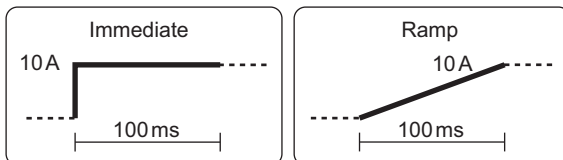

■ Wait (pre)

Set the pre-trigger source. If you set the pre-trigger source, the program pauses before executing a step. The pause is released when the specified trigger source condition is met.

Press MSync, Digital2, and BUS to turn each trigger source on or off. The value switches between on and off each time you press the key.

| Trigger source | Description |
|----------------|-----------------------------------------------------------------------------------------|
| MSync | Synchronizes the releasing of the paused state on synchronized PLZ-5Ws (p.72). |
| Digital2*1 | Releases the pause state when a signal is received at pin 13 of the EXT CONT connector. |
| BUS*2 | Releases the pause state when a *TRG command is received from a PC or the like. |

*1. Only when Direction of Digital 2 is set to Input (p.115).

*2. If set to BUS, other trigger sources cannot be set.

■ **Wait (post)**

Set the post-trigger source (Trig IN). If you set Trig IN, the program pauses after executing a step. Releases the pause state when a trigger is received (p.102).

Trig IN switches between on and off each time you press the Trig IN key.

■ **Generate**

Set the trigger signal output at the start of a step.

Press TA Link and Trig Out to turn each trigger output on or off. The value switches between on and off each time you press the key.

| Value | Description |
|----------|---------------------------------------------------------------------------------------------------------------------------------------------------------------------------------------------|
| TA Link | A trigger is output at the start of a step. In the trigger setting (p.48) of the measurement function, setting Source to TA Link causes measurements to be recorded at the start of a step. |
| Trig Out | A 10 μs trigger signal is output from the TRIG OUT connector. |

Example: When Generate is set to Trig Out in step 2.

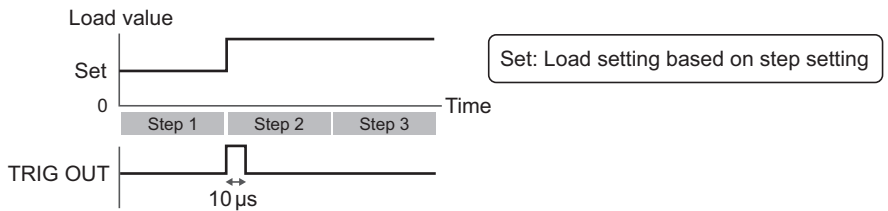

■ →

Set whether to set the EXT CONT connector pins (DIGITAL 0, 1, 2) to high level during a step.

Press Digital0, Digital1, and Digital2 to turn each item on or off. The value switches between on and off each time you press the key.

| Value | Description |
|------------|--------------------------------------------------------------------|
| Digital0 | Pin 11 (DIGITAL 0) of the EXT CONT connector is set to high level. |
| Digital1 | Pin 12 (DIGITAL 1) of the EXT CONT connector is set to high level. |
| Digital2*1 | Pin 13 (DIGITAL 2) of the EXT CONT connector is set to high level. |

*1. Only when Direction of Digital 2 is set to Output (p.115).

Example: When → is set to Digital0 in step 2

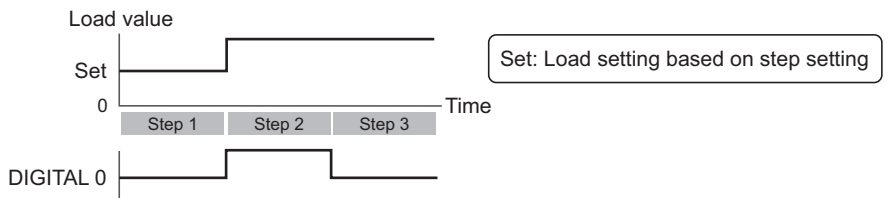

Deleting steps

- 1 Press SEQUENCE and then Steps.**
- 2 Use the rotary knob to select the step, and then press Delete.**

The selected step is deleted.
- 3 Press Save.**

The program is updated.
This completes the setting.

Sequence Creation Tutorial

In this example, we will actually create a sequence from the front panel.

We will enter the following program in CC mode for the PLZ1205W.

Program name: Program1, number of loops: 2

| Run | Current | Execution time | Load | Transition | Trigger output |
|--------|---------|----------------|------|------------|----------------|
| Step 1 | 8 A | 10 seconds | On | Ramp | None |
| Step 2 | 6 A | 12 seconds | On | Immediate | None |
| Step 3 | 0 A | 7 seconds | Off | – | None |
| Step 4 | 3 A | 15 seconds | On | Immediate | Trig Out |

Program1 executes steps 1 to 4 and ends the first execution. When Program1 is executed one more time, this sequence is over.

Representing this sequence in graph form looks as follows.

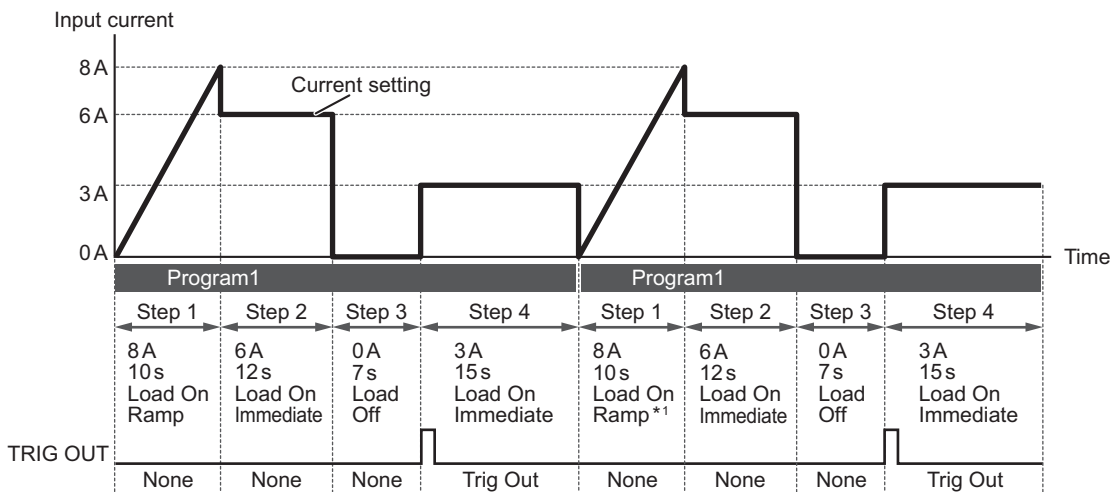

*1 If Load of step 1 is set to Ramp and the program is repeated, the start current of step 1 will always be 0 A.

Creating Program1 as a new program

- 1 Set the operation mode to CC (p.26).
- 2 Press SEQUENCE, Program, and then Create.
- 3 Use the numeric keypad or the rotary knob to enter program name "Program1", and then press ENTER.
Program1 is created.

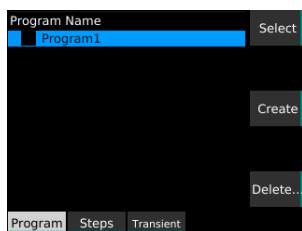

Registering steps to Program1

When registering steps to a program, we recommend that you save the program after setting all the steps. There is no need to save a program after setting each step.

Creating step 1

- 1 Use the rotary knob to select Program1, and then press Select.**
A check mark appears to the left of Program1.
- 2 Press Steps and then Edit.**
The Level (current) cell of step 1 becomes editable.
- 3 Use the numeric keypad or the rotary knob to enter the current value “8”, and then press Edit.**
This sets the value to 8 A.
- 4 Use the ► key to select a cell in the Dwell column, and then press Edit.**
Dwell (execution time) becomes editable.
- 5 Use the numeric keypad or the rotary knob to enter execution time “10”, and then press Edit.**
This sets the value to 10 s.
- 6 Use the ► key to select a cell in the Load column, and then press Edit.**
Load (load and transition) becomes editable.
- 7 Press Ramp and then Edit.**
 (load on, ramp transition) is set.
Proceed to create step 2.

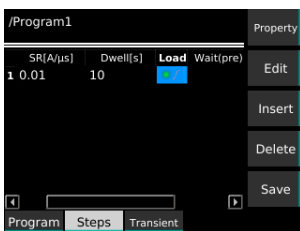

Creating step 2

- 1 Press Insert.**
Step 2 is inserted.
- 2 Use the ◀ key to select a cell in the Level column of Step 2 (row 2), and then press Edit.**
- 3 Set step 2 as follows: Level: 6, Dwell: 12, Load: On (Immediate).**
The current is set to 6 A, the execution time to 12 s, and the load to on. Immediate transition is selected. Proceed to create step 3.

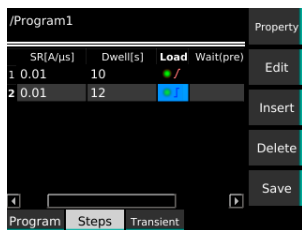

Creating step 3

- 1 Press Insert.**
Step 3 is inserted.
- 2 Use the ◀ key to select a cell in the Dwell column of Step 3 (row 3), and then press Edit.**
Because the load is off in this step, there is no need to set the current.
- 3 Set step 3 as follows: Dwell: 7, Load: Off (blank).**
The execution time is set to 7 s and the load to off. Proceed to create step 4.



Creating step 4

- 1 Press Insert.**
Step 4 is inserted.
- 2 Use the ◀ key to select a cell in the Level column of Step 4 (row 4), and then press Edit.**
- 3 Set step 4 as follows: Level: 3, Dwell: 15, Load: On (Immediate).**
The current is set to 3 A, the execution time to 15 s, and the load to on. Immediate transition is selected. Proceed to setting the number of loops.

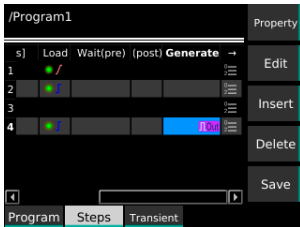

Setting the number of loops

- 1 Press Property and then Loop.**
- 2 Use the numeric keypad or the rotary knob to enter number of loops "2."**
- 3 Press Property.**
The number of loops is set to 2. Proceed to saving Program1.

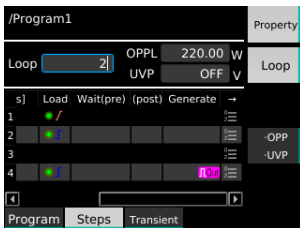

Saving Program1

- 1 Press Save.**
Program1 is saved.
This completes the setting.

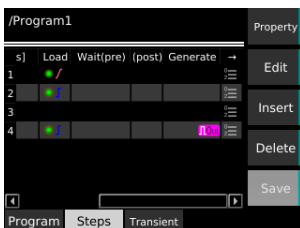

Executing, Pausing, and Stopping Sequences

When you finish setting the program and steps, you can run the sequence. You can pause or stop the sequence while it is running. By setting triggers (p.89), you can control the timing at which sequences are to be started.

Executing a sequence

NOTE

During sequence execution, the switching function and short function are forcibly turned off.

The sequence can be executed regardless of whether the load is on or off.

1 Set the operation mode (p.25) and range (p.34) according to the sequence to be executed.

If the load setting of the sequence exceeds the present range rating, the load setting during sequence execution is limited by the present range rating.

If the load setting of the sequence is less than the present range resolution, the load setting during sequence execution is limited by the present range resolution.

2 Press SEQUENCE and then Program.

3 Use the rotary knob to select the program, and then press Select.

A check mark appears to the left of the program name.

4 Press Transient and then Initiate.

The sequence is executed, and the measurements and  appear on the display.



Number of running loops/total number of loops

The running step is highlighted in blue.

When the sequence is completed, a sequence completion message appears.

The value at the end of the sequence will be the value of the last step.

Synchronizing the start timing of sequences

The start timing of sequences can be synchronized on synchronized PLZ-5Ws. For details, see “Synchronizing the start of sequences” (p.71).

Pausing a sequence

1 Press Suspend during sequence execution.

The sequence is paused. Press Resume to resume the sequence.



Aborting a sequence

Pressing Abort during sequence execution stops the sequence execution in progress (if the load is on, it remains on).

Controlling the start of sequences with triggers

By setting triggers, you can control the timing at which sequences are to be started. The triggers that you can set are as follows:

| Item | Value | Description |
|---------|-----------------------------|--------------------------------------------------------------------------------------------------------------------------------------------------------------|
| Trigger | – | Sets the trigger. |
| Source | – | Event (trigger source) that will be used as a condition for starting sequences. Sequence starts after the Initiate key is pressed and a trigger is received. |
| | Immediate (factory default) | Pressing Initiate without waiting for a trigger signal applies a trigger immediately. |
| | BUS | Applies a trigger when a *TRG command is received from a PC or the like. |
| | DIGITAL2*1 | Applies a trigger when a signal is received at pin 13 of the EXT CONT connector. |
| | MSync | The trigger application timing is synced between PLZ-5W that are synchronized (p. 71). |
| Delay | 0 s to 100 s | Set the delay time from trigger application until the start of sequence. The factory default setting is 0 s. |

*1. Only when Direction of Digital 2 is set to Input (p. 115).

■ **Trigger application examples**

Example: Source is set to Immediate

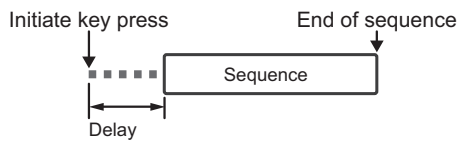

Example: Source is set to BUS, DIGITAL2, or MSync

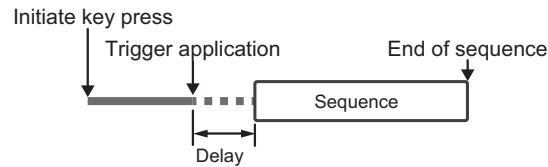

■ **Trigger processing procedure**

The general trigger processing procedure is illustrated in the following figures.

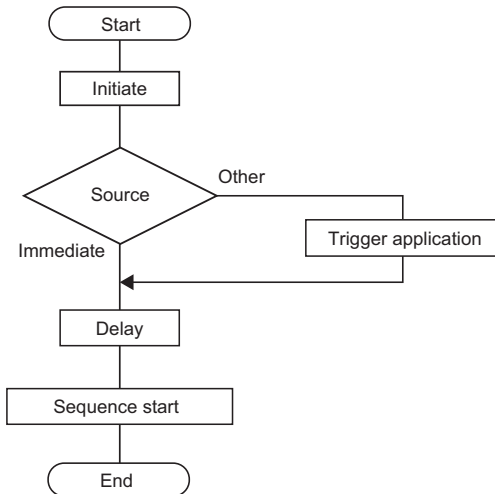

- 1** Press SOURCE and then More.
- 2** Use the rotary knob to select the trigger (p.89), and then press Edit.



- 3** Use the rotary knob or numeric keys to perform input, and then press ENTER.
Repeat steps step 2 and step 3 to set triggers.
This completes the setting.

External Control

Preparation for External Control

The PLZ-5W can be controlled and monitored from an external device.

The BNC connectors (I MON OUT, TRIG OUT) are isolated from the chassis and load input terminals.

| Control | Functions that can be controlled/monitored | Connector |
|-------------------|-----------------------------------------------------------------------------------------------------------------------------------------------------------------------|-----------------------|
| Analog control | Controlling the load values of CC, CP, CR, and CV modes using voltage. Controlling the current to be superimposed on the load values of CC mode using voltage. | EXT CONT |
| Digital control*1 | Load on/off control Current range control Sequence and measurement triggers Releasing a paused sequence Activation of an alarm Clearing an alarm state | EXT CONT |
| Signal output | Monitoring of the load on/off state Monitoring of the current range Monitoring of the alarm state Relay contact output of short function | EXT CONT |
| | Monitoring of input current | EXT CONT I MON OUT |
| | Trigger output for switching and sequence | TRIG OUT |

*1. If a relay is used for the digital control input, erroneous signals may be detected due to the chattering of the relay. To prevent erroneous detections, attach 0.1 μ F to 1 μ F capacitors at both ends of the relay contact.

Precautions for high-speed load simulations

During high-speed load simulation, do not connect the common terminal of the external device to the terminal of the DUT (the terminal that is connected to the negative (-) input terminal of the PLZ-5W). Attach a commercially available ferrite core to the wiring between the PLZ-5W and the external device.

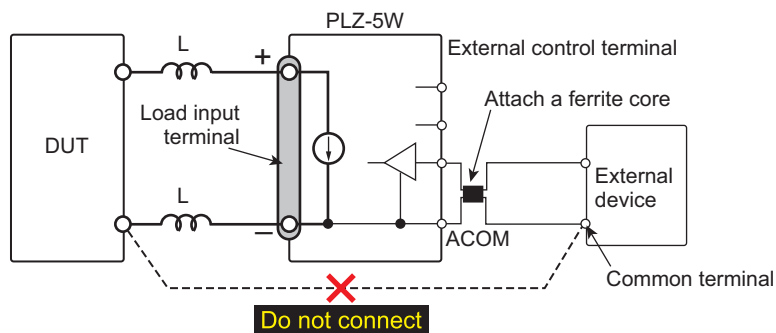

EXT CONT connector pin arrangement

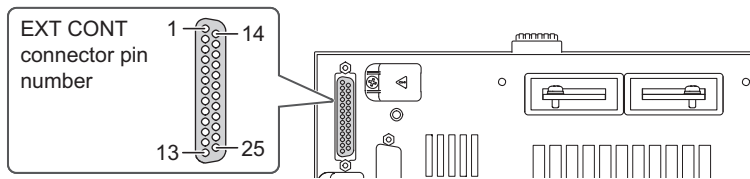

| Pin no. | In/Out | Signal name | Description |
|---------|--------|------------------|-----------------------------------------------------------------------------------------------------------------------------------------------------------------------------------------------------------------------------------------------------------------------------|
| 1 | – | STATUS COM | Status signal common for pins 2, 3, 14 to 16. |
| 2 | OUT | RANGE STATUS 0 | Range status output (p.100). |
| 3 | OUT | RANGE STATUS 1 | |
| 4 | IN | RANGE CONT 0 | Range control input (p.100). |
| 5 | IN | ALARM CLEAR | Alarm clearing input (p.101). |
| 6 | IN | ALARM INPUT | Alarm input (p.101). |
| 7 | OUT | SHORT SIGNAL OUT | Short contact output (30 Vdc/1 A) (p.36). |
| 8 | OUT | SHORT SIGNAL OUT | |
| 9 | IN | TRIG INPUT | Trigger input. Resumes program execution if Wait(post) was set to Trig IN in a sequence step and the program was paused (p.102). |
| 10 | – | A COM | Connected to the negative (-) polarity of the load input terminals on the rear panel. |
| 11 | OUT | DIGITAL 0 | DIGITAL0 output (p.103). Sequence control possible. |
| 12 | OUT | DIGITAL 1 | DIGITAL1 output (p.103). Sequence control possible. |
| 13 | IN/OUT | DIGITAL 2 | DIGITAL2 I/O (p.103). Input/output switchable (p.115). Sequence signal output or the trigger input of sequences and measurement function. |
| 14 | OUT | ALARM1 | ALARM1 output (p.101). ON when overvoltage detection, reverse-connection detection, overheat detection, alarm input detection, front-panel load terminal overcurrent detection, or parallel operation anomaly detection is activated, and also during external alarm input. |
| 15 | OUT | ALARM2 | ALARM2 output (p.101). ON during OCP, OPP, UVP, or WDP operation. |
| 16 | OUT | LOAD ON STATUS | Load-on status output (p.99). ON during load on. |
| 17 | IN | RANGE CONT 1 | Range control input (p.100). |
| 18 | IN | LOAD ON/OFF CONT | Load on/off control input (p.98). Logic level switchable. |
| 19 | – | A COM | Connected to the negative (-) polarity of the load input terminals on the rear panel. |
| 20 | IN | EXT CONT ADD | External voltage control input (p.97). Controls the load setting of CC mode by adding current. |
| 21 | IN | EXT CONT MODE | External voltage control input (p.95). Controls the load values of CC, CR, and CP modes. |
| 22 | IN | EXT CONT CV | External voltage control input (p.96). Controls the voltage of CV mode. |
| 23 | – | A COM | Connected to the negative (-) polarity of the load input terminals on the rear panel. |
| 24 | OUT | IMON | Current monitor output (p.104). |
| 25 | – | N.C. | – |

Connecting to the EXT CONT connector

Storing the protection plate

⚠ WARNING Risk of electric shock. The EXT CONT connector contain pins that have the same potential as the output terminal. When the connector is not in use, be sure to attach the protection plate that comes with the PLZ-5W.

By factory default, the protection plate is mounted on the EXT CONT connector. When using the EXT CONT connector, keep the removed protection plate in a safe place. If it is damaged or lost, contact your Kikusui agent or distributor.

External control connector kit

To connect the signal cable to the EXT CONT connector, use the external control connector kit that comes with the PLZ-5W. For information about how to use this kit, see the TE Connectivity (formerly AMP) catalog. For information about how to obtain these tools or replacement parts, contact your Kikusui agent or distributor.

| | |
|---------------------------------|------------------------------------------------------------------------------------------------------|
| Connector model (on the PLZ-5W) | 5747461-3 [made by TE Connectivity] |
| Plug model | 745211-7 [made by TE Connectivity] |
| Wire diameter | AWG26 to AWG22 |
| Manual pressure welding tool | Handle assembly 58074-1 [made by TE Connectivity] Head assembly 58063-2 [made by TE Connectivity] |
| Insertion/extraction tool | 91232-1 [made by TE Connectivity] or equivalent |

Connecting the signal cable

- 1** Turn off the PLZ-5W's POWER switch.
- 2** Remove the protection plate of the EXT CONT connector.

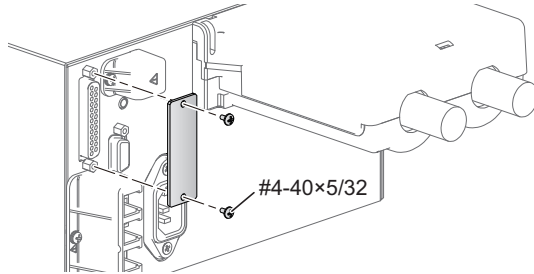

- 3** Connect the signal cable to the EXT CONT connector.

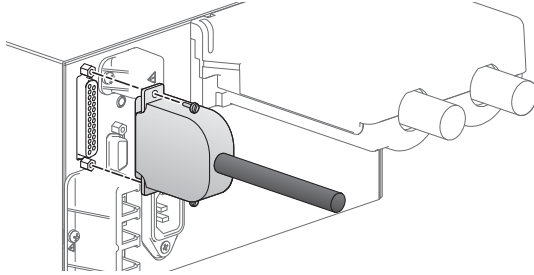

- 4** Connect the signal cable to the external controller.
This completes the external control connection procedure.

Load Setting Control

Constant current (CC), constant resistance (CR), and constant power (CP) control

You can control the load values (current, conductance, power) of CC, CR, and CP modes using external voltage. When you apply an external voltage between 0 V to 10 V to the EXT CONT connector, a load setting proportional to the change can be obtained.

An external voltage of 0 V results in a load value that is 0 % of the range rating, and an external voltage of 10 V in a load value that is 100 % of the range rating. The accuracy cannot be guaranteed when the external voltage is less than 0 V or more than 10 V.

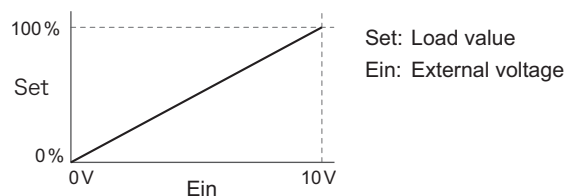

⚠ CAUTION

To avoid damaging the product, observe the following precautions.

- The maximum voltage that can be applied across pins 21 and 23 of the EXT CONT connector is ± 11 V. Do not apply a voltage that exceeds this.
- Pin 23 of the EXT CONT connector is connected to the negative (-) load input terminal. Make sure that the wire of pin 23 does not touch any of the other pins.

1 Turn the POWER switch off.

2 Connect an external voltage across pins 21 and 23 of the EXT CONT connector.

To prevent noise interference, use twisted wires for the signal cables. Use a highly stable external voltage that has low noise.

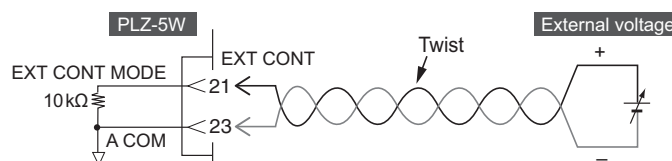

3 Turn the POWER switch on and check that the load is off.

4 Sets the operation mode to CC, CR, or CP, and set the current range.

If you also want to control the current range externally, be sure to set the range to H.

5 Press SOURCE and then More.

6 Use the rotary knob to select CC, CR, or CP under External Control, and then press the Edit key.

7 Use the rotary knob to select Enable, and then press ENTER.

External control of each mode becomes possible. If Disable is selected, external control of each mode is disabled. This completes the setting.

Constant voltage (CV) control

You can control the voltage in CV mode, CC+CV mode, or CR+CV mode using external voltage. When you apply an external voltage of 0 V to 10 V to the EXT CONT connector, the voltage varies proportionally to that external voltage.

An external voltage of 0 V results in voltage of 0 V. An external voltage of 10 V results in voltage at 100 % of the range rating. The accuracy cannot be guaranteed when the external voltage is less than 0 V or more than 10 V.

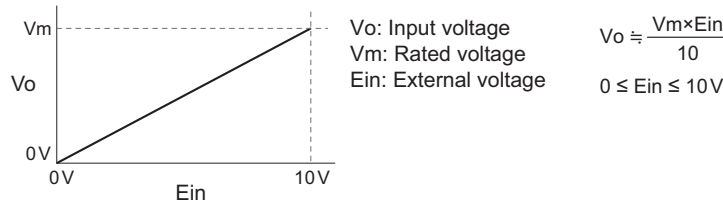

⚠ CAUTION

To avoid damaging the product, observe the following precautions.

- Do not apply a voltage outside ± 11 V across pins 22 and 23 of the EXT CONT connector.
- Pin 23 of the EXT CONT connector is connected to the negative (-) load input terminal. Make sure that the wire of pin 23 does not touch any of the other pins.

1 Turn the POWER switch off.

2 Connect an external voltage across pins 22 and 23 of the EXT CONT connector.

To prevent noise interference, use twisted wires for the signal cables. Use a highly stable external voltage that has low noise.

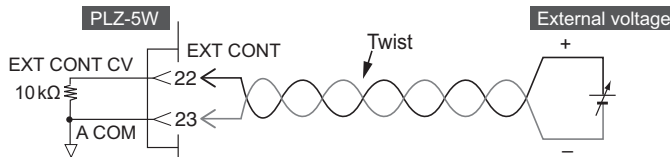

3 Turn the POWER switch on and check that the load is off.

4 Set the operation mode and the current range.

If you also want to control the current range externally, be sure to set the range to H.

5 Press SOURCE and then More.

6 Use the rotary knob to select CV under External Control, and then press the Edit key.

7 Use the rotary knob to select Enable, and then press ENTER.

You can now externally control the voltage in CV mode, CC+CV mode, or CR+CV mode. If Disable is selected, external control in CV, CC+CV, and CR+CV modes is disabled.

This completes the setting.

Controlling the current to be superimposed on the constant current (CC)

You can control the current to be superimposed to the current value of CC mode with an external voltage.

When you apply an external voltage between 0 V to 10 V to the EXT CONT connector, the load current becomes the sum of the current proportional to the external voltage change and the Present current setting.

When you apply an external voltage between -10 V to 0 V to the EXT CONT connector, the load current is equal to the current that is proportional to the external voltage change subtracted from the present current setting.

The current that is added to the current setting for an external voltage of 0 V is 0 A. The current that is added to the current setting for an external voltage of ± 10 V is 100 % of the rating. However, the final load current range is 0 A to 100 % of the range rating.

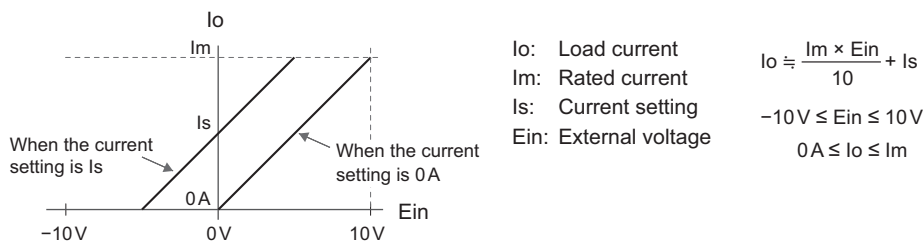

CAUTION

To avoid damaging the product, observe the following precautions.

- Do not apply a voltage outside ± 11 V across pins 19 and 20 of the EXT CONT connector.
- Pin 19 of the EXT CONT connector is connected to the negative (-) load input terminal. Make sure that the wire of pin 19 does not touch any of the other pins.

1 Turn the POWER switch off.

2 Connect an external voltage across pins 19 and 20 of the EXT CONT connector.

To prevent noise interference, use twisted wires for the signal cables. Use a highly stable external voltage that has low noise.

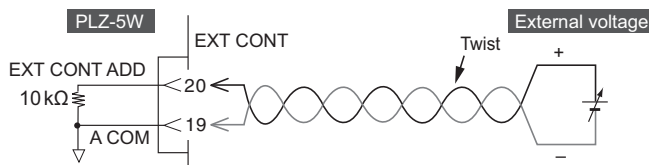

3 Turn the POWER switch on and check that the load is off.

4 Sets the operation mode to CC mode, and set the current range.

If you also want to control the current range externally, be sure to set the range to H.

5 Press SOURCE and then More.

6 Use the rotary knob to select CC Add under External Control, and then press Edit.

7 Use the rotary knob to select Enable, and then press ENTER.

External control of superimposing in CC mode is now possible. If Disable is selected, external control of superimposing in CC mode is disabled. This completes the setting.

Controlling Load On/Off

You can control load on/off with an external signal. You can also monitor the load on/off state.

Load on/off control input

You can externally control load on/off with an external signal, by using an external contact.

The priority relationship between the operation of the external contact and the operation of the LOAD key on the front panel is as shown in the following figure.

The OUTP command during remote control is equivalent to the LOAD key.

Relationship between external contact and LOAD key (when Input Logic is Positive)

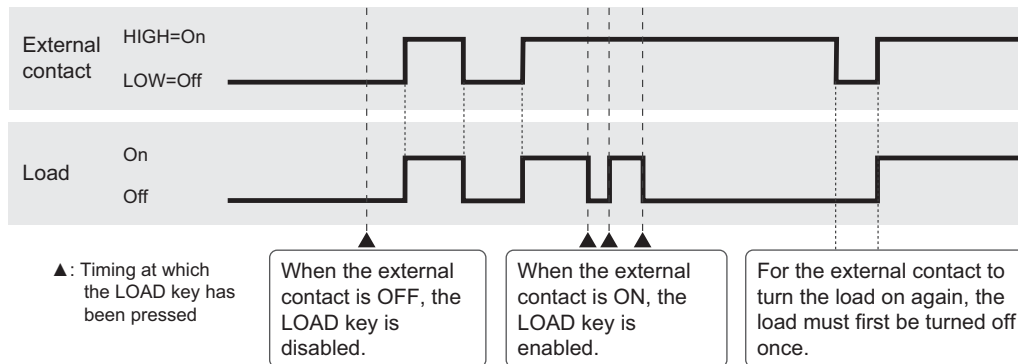

- 1** Turn the POWER switch off.
- 2** Connect an external contact across pins 18 and 19 of the EXT CONT connector.

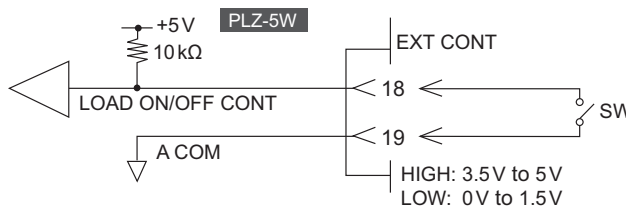

- 3** Press SOURCE and then More.
- 4** Use the rotary knob to select Input Logic under External Control, and then press Edit.
- 5** Use the rotary knob to select the item, and then press ENTER.

| Item | Description |
|----------|-----------------------------------------------------------------------------------|
| Positive | Opening and closing the external contact turns the load on and off, respectively. |
| Negative | Opening and closing the external contact turns the load off and on, respectively. |

External control of load on/off is now possible.

This completes the setting.

Load-on status signal output

To externally monitor the load on/load off state, use pin 16 of the EXT CONT connector. Use pin 1 as the common.

Maximum applied voltage: 30 V

Maximum current: 4 mA

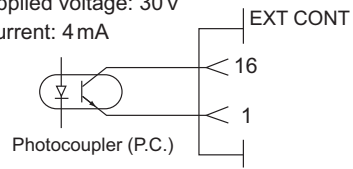

| | Load on | Load off |
|--------------|---------|----------|
| Photocoupler | ON | OFF |

Current Range Control

You can control the current range with an external control signal. You can also monitor the current range state by using range status output.

| | Current Range | | | Range control input*1 | | Range status output*2 | |
|---|---------------|---------|----------|-----------------------|--------------|-----------------------|----------------|
| | PLZ205W | PLZ405W | PLZ1205W | RANGE CONT 0 | RANGE CONT 1 | RANGE STATUS 0 | RANGE STATUS 1 |
| H | 40 A | 80 A | 240 A | HIGH | HIGH | OFF | OFF |
| M | 4 A | 8 A | 24 A | HIGH | LOW | OFF | ON |
| L | 0.4 A | 0.8 A | 2.4 A | LOW | HIGH | ON | OFF |

*1. HIGH: 5 V, LOW: 0 V

*2. OFF: OPEN, ON: SHORT

NOTE

- When externally controlling the current range, set the current range of the PLZ-5W to the H range beforehand (p.34).
- If the current range is changed to other than H range using external control, an asterisk will appear on the current range icon. Example: **4A***

Range control input

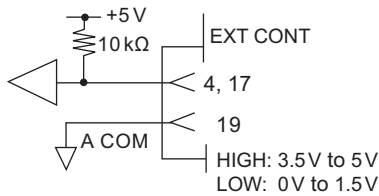

Use pin 4 (RANGE CONT 0) and pin 17 (RANGE CONT 1) of the EXT CONT connector. Use pin 19 as the common. This is a 2-bit signal.

Range status output

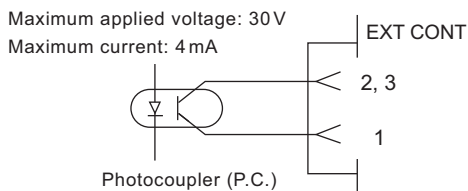

Use pin 2 (RANGE STATUS 0) and pin 3 (RANGE STATUS 1) of the EXT CONT connector. Use pin 1 as the common. This is a 2-bit signal.

Controlling Alarms

You can use an external control signal to activate the PLZ-5W's alarm. You can also monitor alarm occurrences.

Alarm input

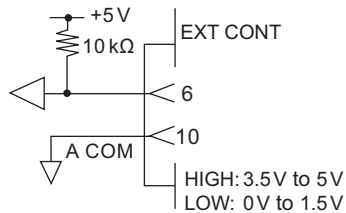

Use pin 6 of the EXT CONT connector. Use pin 10 as the common. An alarm is activated and the load is turned off when the input to pin 6 is a low level signal.

Alarm clearing input

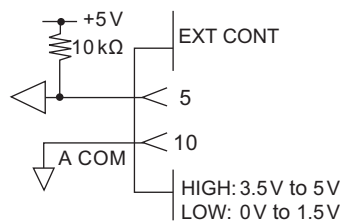

Use pin 5 of the EXT CONT connector. Use pin 10 as the common. After an alarm occurs, eliminate the root cause of the alarm, and change the input to pin 5 of the EXT CONT connector from a low level signal to a high level signal. The alarm will be cleared on the rising edge of this signal.

Alarm status output

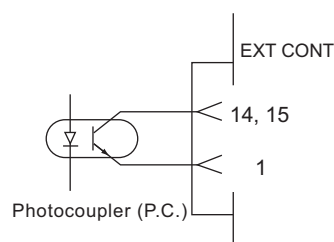

Maximum applied voltage: 30V
Maximum current: 4 mA

Use pin 14 (ALARM1) and pin 15 (ALARM2) of the EXT CONT connector. Use pin 1 as the common.

Pin 14 turns on when alarm 1 ([p.40](#)) is activated.
Pin 15 turns on when alarm 2 ([p.40](#)) is activated.

Trigger Input/Output

There is a trigger output connector (TRIG OUT) on the front panel, and a trigger input connector (EXT CONT pin 9) on the rear panel.

Trigger input

When Wait(post) is set to Trig IN in a sequence step setting (p. 80), the sequence is paused at the end of the step. In this case, when the signal input to TRIG INPUT (pin 9) of the EXT CONT connector changes from high to low level, the pause is released at the falling edge of that signal.

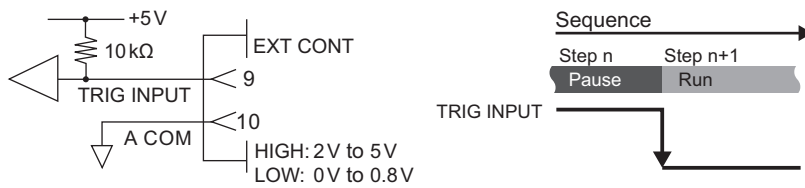

Trigger output

The trigger signal is output under the following conditions.

| Conditions | Pulse width |
|-----------------------------------------------------------------------------------------------|-------------|
| During switching operation (p. 37). | 1 μ s |
| When a step for which Trig Output has been set is executed during sequence operation (p. 82). | 10 μ s |

The trigger signal is output from the TRIG OUT connector (BNC connector) on the front panel. The voltage of the trigger signal output is approximately 5 VEMF, and the output impedance is approximately 200 Ω . The isolation voltage between the BNC connectors and chassis is ± 30 V. The rated isolation voltage between BNC connectors and load input terminals is ± 500 V. The TRIG OUT connector is isolated from the chassis and load terminal (A COM).

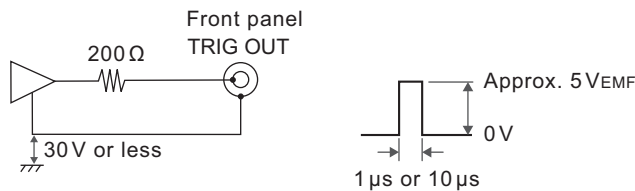

Digital I/O

The rear-panel EXT CONT connectors include digital outputs DIGITAL0 (pin 11), DIGITAL1 (pin 12), and DIGITAL2 (pin 13) and digital input DIGITAL2 (pin 13). The input and output of DIGITAL2 can be switched (p. 115). Digital output is used as a logic signal output during a step of a sequence. Digital input is used as a trigger input for sequence and measurement functions.

■ DIGITAL0, DIGITAL1, DIGITAL2 (output)

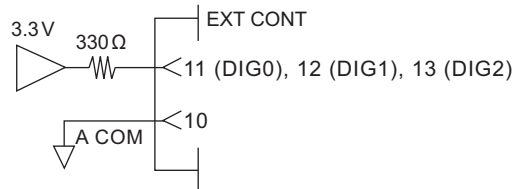

■ DIGITAL2 (input)

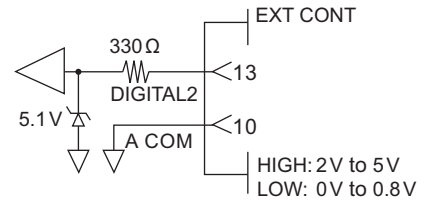

Using the Current Monitor Signal

Current monitor output

You can monitor the current value by using the current monitor signal output. The current monitor signal is output from the I MON OUT connector and across pins 23 and 24 (pin 23 is common) of the EXT CONT connector.

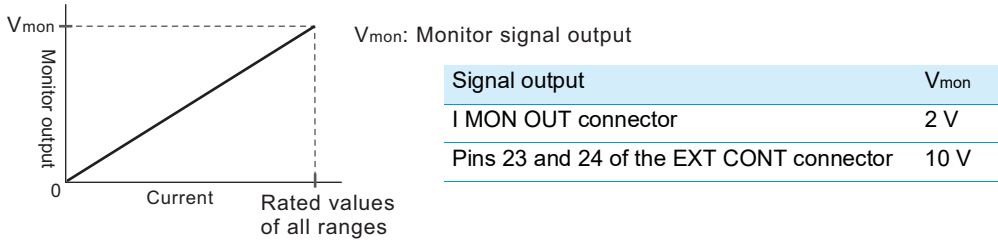

CAUTION To avoid damaging the product, observe the following precautions. Pin 23 of the EXT CONT connector is connected to the negative (-) load input terminal. Make sure that the wire of pin 23 does not touch any of the other pins.

■ Connecting to I MON OUT connector (BNC connector)

The current monitor signal that is output is 2 V in the rating for each range. The maximum output current is 5 mA. The isolation voltage between the BNC connectors and chassis is ±30 V. The rated isolation voltage between BNC connectors and load input terminals is ±500 V. It is isolated from A COM.

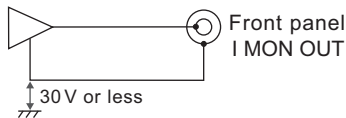

■ Connecting across pins 23 and 24 of the EXT CONT connector

The common is connected to A COM. The current monitor signal that is output is 10 V in the rating for each range. The output impedance is 1 kΩ.

Parallel Operation

Overview of Parallel Operation

The PLZ-5W can be connected in parallel to increase the total current and power capacities. During parallel operation, one unit is set as the master unit. The master unit can control all the PLZ-5W units (slave units) that are connected in parallel. The master unit displays the total current and total power for all the electronic loads that are connected in parallel.

You can use one of the following two methods to perform parallel operation:

■ Parallel operation using the same type of electronic loads

This method involves connecting slave units (same model as the master unit) to one PLZ-5W master unit. You can connect up to 4 slave units. The master unit and the slave units are automatically set according to the connection status.

■ Parallel operation using boosters (PLZ1205W only)

This method involves connecting boosters (PLZ2405WB) to one PLZ1205W unit. You can connect up to four boosters. For details on how to connect units for parallel operation using boosters, see the PLZ2405WB user's manual on the included CD-ROM.



CAUTION

To avoid damaging the product, observe the following precautions. During parallel operation, do not use the load input terminals on the front panel.

NOTE

- During parallel operation, the product may not meet the specifications that it has during independent operation. The setting accuracy and measurement accuracy can be improved by performing calibration in a parallel state. To have your PLZ-5W calibrated, contact your Kikusui agent or distributor.
- The current ripple during parallel operation is approximately equal to the value in the specifications for independent operation multiplied by the number of units in parallel operation.
- The setting resolution during parallel operation varies depending on the number of units in parallel operation.
- The range during parallel operation varies depending on the models connected in parallel (p.163).

Parallel Operation Using the Same Model

The optional parallel operation signal cable kit ([p.171](#)) is required for parallel operation.

Connect slave units (same model as the master unit) to a single PLZ-5W master unit using parallel operation signal cables. You can connect up to 4 slave units.

⚠ WARNING Using improper cables may cause fire. Use load cables with a core diameter that is appropriate for the amount of current being used and with sturdy, flame-resistant insulation.

⚠ CAUTION To avoid damaging the product, observe the following precautions.

- When you are performing parallel operation, be sure to use the load input terminal on the rear panel.
- Do not connect the PARALLEL connector's IN and OUT terminals incorrectly.
- Do not leave one end of the parallel operation signal cable connected to the PARALLEL connector when the other end is not connected.

| Number of slave units | Maximum current / Maximum power | | |
|-----------------------|---------------------------------|--------------|---------------|
| | PLZ205W | PLZ405W | PLZ1205W |
| 1 | 80 A/400 W | 160 A/800 W | 480 A/2400 W |
| 2 | 120 A/600 W | 240 A/1200 W | 720 A/3600 W |
| 3 | 160 A/800 W | 320 A/1600 W | 960 A/4800 W |
| 4 | 200 A/1000 W | 400 A/2000 W | 1200 A/6000 W |

Making connections for parallel operation

Connect the PLZ-5Ws to be operated in parallel to the DUT, and connect each unit using parallel operation signal cables.

1 Turn the load off of all PLZ-5Ws to be connected in parallel.

2 Connect the load input terminals of each unit to the DUT.

Securely connect the load input terminals of multiple units that are the same model to each other in parallel. After making the connections, attach the load input terminal covers (p.15).

- Use load cables that are as short as possible and have sufficient thickness for the current to be used (using the bus bar is recommended).
- Route the load cables as far as possible from the signal cables.
- Use load cables that are all of the same length.

By performing the wiring as shown in the following figure, you can divide the current evenly among the various load cables.

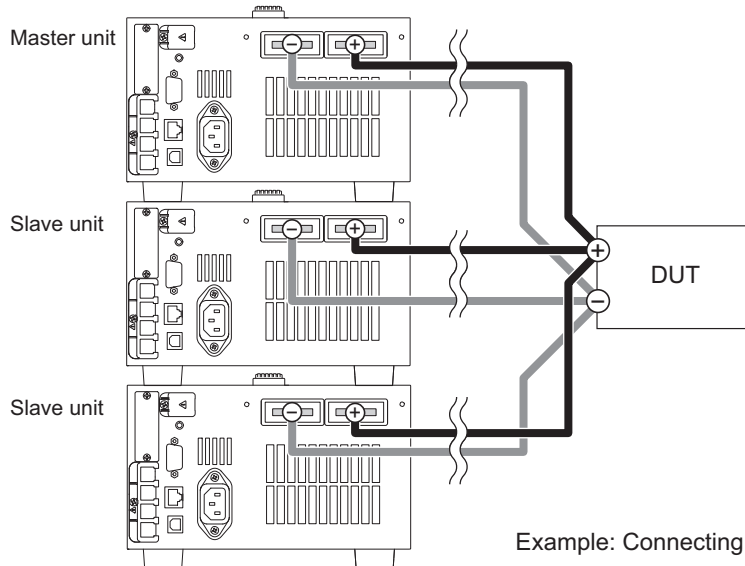

Example: Connecting two slave units

3 Remove the SYNC/PARALLEL port cover.

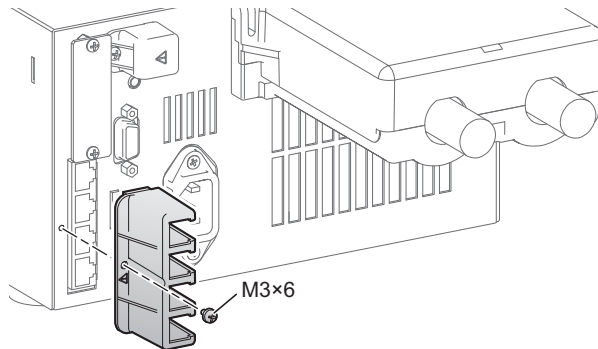

4 Connect all the electronic loads to be operated in parallel with parallel operation signal cables.

Connect the PARALLEL OUT connector and IN connector with a parallel operation signal cable.

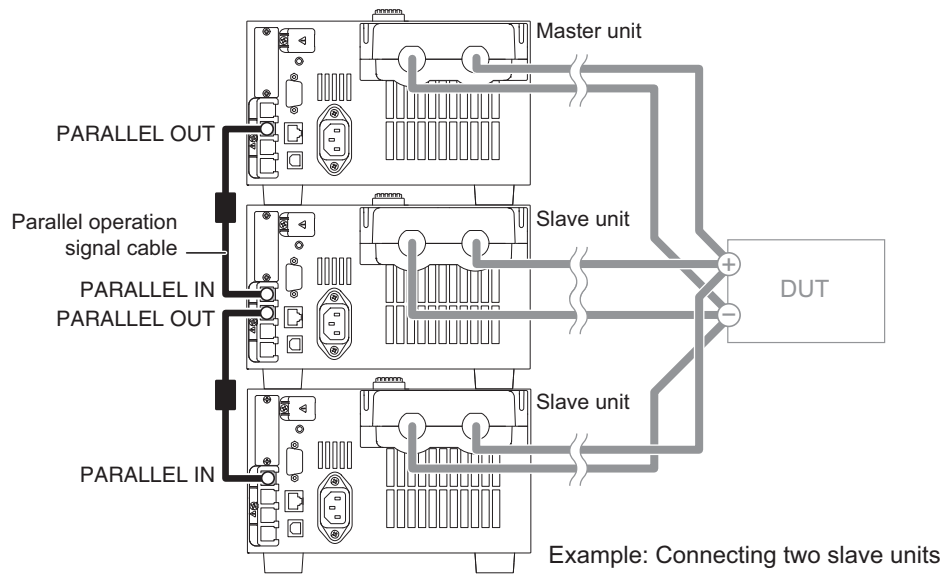

5 Attach the SYNC/PARALLEL port cover.

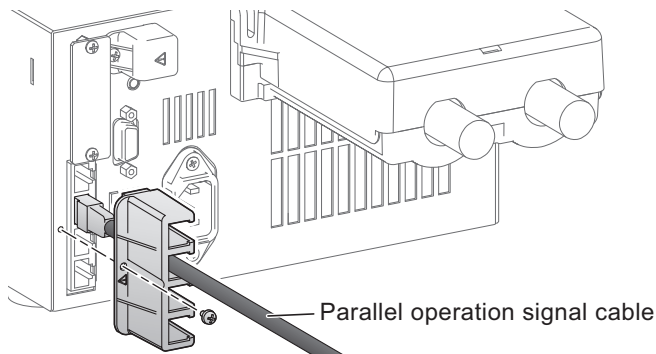

This completes the connections.

Performing parallel operation

Once a parallel connection is made, the master unit and slave units are automatically identified, so parallel operation can be used immediately. In addition, the current range on the master unit display increases.

For the operating range, see the appendix (p.163).

Turning the output on and off

Turn the POWER switches of all the PLZ-5Ws on or off in any order.

Slew rate and response speed settings during parallel operation

During parallel operation, the slew rate and response speed settings on the master unit are used. The slew rate increases proportionally to the number of units operating in parallel. For details, see “Slew rate during parallel operation using the same model” (p.163) or “Slew rate during parallel operation using boosters” (p.165).

In the following cases, set the response speed (p.54) to Normal to ensure stable operation.

- If the inductance of the wiring will be increased and large voltage drops will occur owing to current changes.
- If control of the PLZ-5W may become unstable and oscillation phenomena may occur owing to phase lag of the current.

Protection function during parallel operation (parallel operation anomaly detection)

When an anomaly occurs during parallel operation, the following alarms appear on the displays of the master and slave units, and the loads are turned off.

| Display | Applicable unit | Operating condition | Clearing method |
|---------------------------------------|-----------------|--------------------------------------------------------------------------------------------------|----------------------------------------------------------------------------------------------------------------------------------------|
| Parallel Communication Alarm | Master unit | A communication anomaly was detected during parallel operation. | Restart. If you cannot clear the alarm, the PLZ-5W may have malfunctioned. If this happens, contact your Kikusui agent or distributor. |
| Parallel Slave Front Alarm | Master unit | A current of 80 A or higher flowed through the front panel load input terminals of a slave unit. | Press ENTER on the master unit. |
| Front Alarm | Slave unit | A current of 80 A or higher flowed through the front panel load input terminals of a slave unit. | Press ENTER on the master unit. |
| Parallel Slave Over Temperature Alarm | Master unit | An overheating of a slave unit was detected. | Press ENTER on the master unit. |
| OTP Alarm | Slave unit | An overheating of master unit was detected. | Press ENTER on the master unit. |
| AC Fail Alarm | Master unit | A slave unit's power supply was interrupted. | Restart |

| Display | Applicable unit | Operating condition | Clearing method |
|----------------------------|-----------------|----------------------------------------|---------------------------------|
| Parallel Master Lost Alarm | Slave unit | The master unit cannot be detected. | Restart |
| Alarm | Slave unit | An alarm of another unit was detected. | Press ENTER on the master unit. |

Canceling parallel operation

To end parallel operation and return to standalone operation, turn all the units off, and then remove the parallel operation signal cables from the PARALLEL connectors.

 **CAUTION** To avoid damaging the product, observe the following precautions. Do not perform stand-alone operation with the parallel operation signal cable left connected to the PARALLEL connector.

System Settings

Displaying and Changing CONFIG Settings

You can set the following parameters using the CONFIG settings.

| Parameter | Value ^{*1} | Description |
|----------------|---------------------------------------------------------------------------------------------------------------|-------------------------------------------------------------|
| Remote Sensing | <u>Enable/Disable</u> | Remote sensing (p.57). |
| Power On | <u>RST/RCL0/Resume</u> | Panel settings at startup (p.112). |
| Watchdog | <u>Enable/Disable</u> | Watchdog protection setting (p.45). |
| Delay | 1 second to 3600 seconds (1 second unit) Factory default is 60 seconds. | Time until watchdog times out. |
| Screen Saver | <u>Enable/Disable</u> | Screen saver (p.113). |
| Delay | 60 seconds to 59940 seconds (after setting, rounded to nearest second unit) Factory default is 60 seconds. | Time until the screen saver starts. |
| Key | – | – |
| Lock Level | <u>Low/Medium/High</u> | Key lock level (p.114). |
| Beeper | – | Beep sound setting (p.115). |
| Key | <u>Enable/Disable</u> | Beep sound for invalid operation. |
| Protection | <u>Enable/Disable</u> | Beep sound for alarm occurrence. |
| SCPI | <u>Enable/Disable</u> | Beep sound for SCPI errors. |
| Digital2 | – | – |
| Direction | <u>Input/Output</u> | I/O direction of DIGITAL2 signal (p.115). |

*1. Factory default settings are underlined.

Remote sensing

You can enable or disable remote sensing. For details on remote sensing, see “Remote Sensing” ([p.56](#)).

Panel settings at startup

The panel setting state at power-on can be selected.

1 Press SYSTEM.

If the Configure screen does not appear, press Configure.

2 Use the rotary knob to select Power on, and then press Edit.

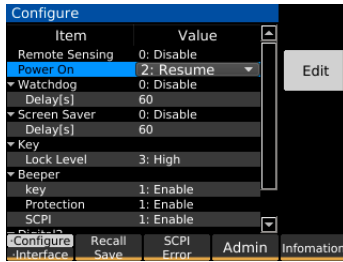

3 Use the rotary knob to select the following items.

| Parameter | Description |
|-----------|----------------------------------------------------------------------------------------------------------|
| RST | Start with the reset settings (p. 123). |
| RCL0 | Start in setup memory (p. 63) 0 condition. |
| Resume | Start with the same settings as when the power was switched off the previous time (but always load off). |

4 Press ENTER.

This completes the setting.

Watchdog protection setting (WDP)

You can enable or disable WDP and set the WDP value. For details on WDP, see “Setting watchdog protection (WDP)” ([p. 45](#)).

Screen saver

The display dims when there is no panel activity for a specified length of time.

1 Press SYSTEM.

If the Configure screen does not appear, press Configure.

2 Use the rotary knob to select Screen Saver, and then press Edit.

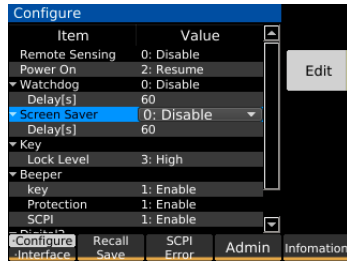

3 Use the rotary knob to select Enable, and then press ENTER.

Selecting Disable disables the function.

4 Use the rotary knob to select Delay, and then press Edit.

5 Use the numeric keypad or the rotary knob to set the time until the screen saver is activated, and press ENTER.

This completes the setting.

Key lock

You can prohibit operation of the keys to prevent erroneous operations such as settings getting changed or memories and sequences getting overwritten.

Setting the key lock level

You can set three different key lock levels according to the type of keys whose operation is prohibited.

1 Press SYSTEM.

If the Configure screen does not appear, press Configure.

2 Use the rotary knob to select Lock Level under Key, and then press Edit.

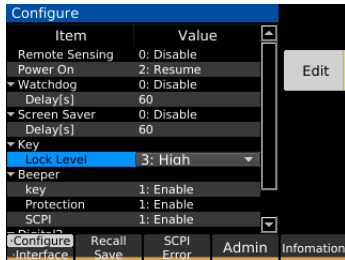

3 Use the rotary knob to select the key lock level.



| Level | Description |
|----------|--------------------------------------------------------------------------------------------------------------------------------------------------------------------------------------------------------------------|
| 1:Low | Locks all operations except the following. <ul style="list-style-type: none"> • Release key lock • Load on/off • Used to recall setup memory. • ABC preset memory recall |
| 2:Medium | Locks all operations except the following. <ul style="list-style-type: none"> • Release key lock • Load on/off |
| 3:High | All key operations are locked except key lock release. |

4 Press ENTER.

This completes the setting.

Setting or releasing key lock

1 Hold down KEY LOCK.

Each time KEY LOCK is held down, key lock switches between lock and unlock. While key lock is enabled, , , or  is shown in the upper right of the display depending on the key lock level.

This completes locking or unlocking.

Setting the beep sound

You can enable or disable beep sounds that are emitted in case of invalid operation, alarm occurrence, or SCPI error.

1 Press SYSTEM.

If the Configure screen does not appear, press Configure.

2 Use the rotary knob to select the following items under Beeper, and then press Edit.

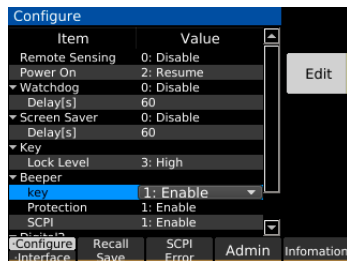

| Parameter | Description |
|------------|----------------------------------|
| Key | Beep sound for invalid operation |
| Protection | Beep sound for alarm occurrence |
| SCPI | Beep sound for SCPI errors |

3 Use the rotary knob to select Enable or Disable, and then press ENTER.

This completes the setting.

Setting the DIGITAL2 signal input/output

1 Press SYSTEM.

If the Configure screen does not appear, press Configure.

2 Use the rotary knob to select Direction under Digital2, and then press Edit.

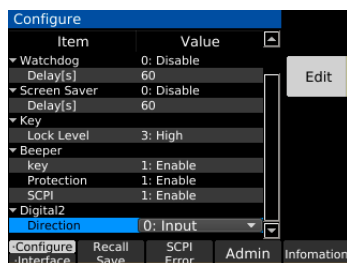

3 Use the rotary knob to select Input (digital input) or Output (digital output), and then press ENTER.

This completes the setting.

Displaying/Changing the Interface Settings

You can set the following parameters.

Items that have the ✓ mark in the “Reset” column are returned to their factory default values when the interface settings are reset.

| Parameter | Value ^{*1} | Description | Reset |
|-----------------------|--------------------------------------------------------------------------------------------------------------------------------------|----------------------------------|-------|
| IP Address | – | IP address | |
| Method | <u>Automatic</u> (auto)/Static (fixed) | IP address assignment method | ✓ |
| IP Address | – | IP address | – |
| Subnet Mask | – | Subnet mask | – |
| Default Gateway | – | Default gateway | – |
| DNS Server | – | DNS server address | – |
| DNS Server 1 | – | Primary DNS server address | – |
| DNS Server 2 | – | Secondary DNS server address | – |
| WINS Server | – | WINS server address | |
| WINS Server 1 | – | Primary WINS server address | – |
| WINS Server 2 | – | Secondary WINS server address | – |
| Host name & Services | – | Host name and service | |
| Desired Hostname | Enter the host name (up to 15 characters). Factory default is model name and serial number. | Host name setting | – |
| Desired Description | Enter the service name (up to 63 characters). Factory default is KIKUSUI XXXX Electronic Load (XXXX = model name) and serial number. | mDNS service name setting | – |
| Dynamic DNS | <u>Enable</u> /Disable | Setting of dynamic DNS | ✓ |
| mDNS | <u>Enable</u> /Disable | Setting of multicast DNS | ✓ |
| NetBIOS Over TCP/IP | <u>Enable</u> /Disable | NetBIOS Over TCP/IP setting | ✓ |
| Auto Clock Adjustment | – | Auto clock | |
| NTP Server Hostname | ntp.nict.jp | NTP server address | – |
| Auto Adjustment | <u>Enable</u> /Disable | Setting of auto clock adjustment | – |
| RS232C Settings | – | RS232C settings | |
| Baudrate | 9600/ <u>19200</u> / 38400/ 57600/ 115200 | Baud rate [bps] | – |
| Data Bits | <u>8</u> (fixed) | Data length | – |
| Stop Bits | 1 (fixed) | Stop bits | – |
| Flow Control | <u>None</u> / CTS-RTS | Flow control | – |

*1. Factory default settings are underlined.

1 Press SYSTEM and then Interface.

The Interface screen appears.

If the Interface screen does not appear, press Interface again.

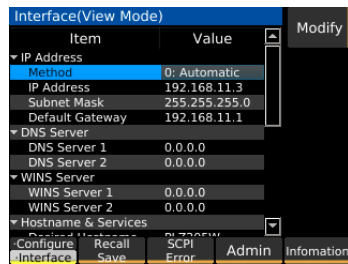
**2 Press Modify, and use the rotary knob to select a setting.****3 Press Edit, use the numeric keypad or the rotary knob to enter the value, and then press ENTER.****4 Press Apply and then ENTER.**

This completes the setting.

Resetting the interface settings

Interface settings that have a ✓ mark in the reset column in (p.116) above are returned to the factory default setting.

1 Press SYSTEM and then Interface.

If the Interface screen does not appear, press Interface again.

2 Press Modify and then LAN Reset.

A confirmation screen appears.

3 Press ENTER.

The interface setting is reset.

Returning the interface settings to the factory default values

- 1 Press SYSTEM and then Interface.**
If the Interface screen does not appear, press Interface again.
- 2 Press Modify and then Default.**
A confirmation screen appears.
- 3 Press ENTER.**
The interface settings are returned to the factory default values.

Displaying SCPI Errors

You can check the content of the SCPI error when an SCPI error occurs during remote control.

Up to 16 errors are displayed. If the 17th error occurs, the 16th error changes to “-350 Queue overflow,” and subsequent errors are not displayed.

1 Press **SYSTEM** and then **SCPI Error**.

The SCPI error is displayed. For details on errors, see the Communication Interface Manual on the included CD-ROM.

Pressing Clear or restarting the PLZ-5W will clear the error.

Setting the Date/Time

The date and time are used when saving setup memory.

If you change the time zone, the year, month, and day change according to it.

If the PLZ-5W is connected to LAN and can access the Internet, the year, month, and day will be updated automatically when you set the time zone.

1 Press SYSTEM, Admin, and then Date Time.

2 Set the time zone and the date and time.

Each time you press Tab, the item that you can set changes.

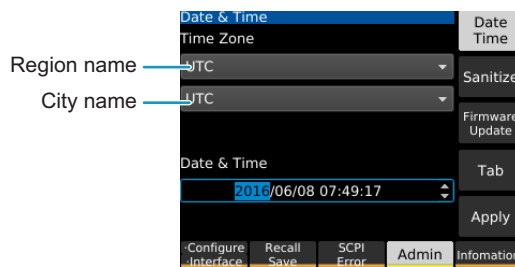

| Purpose | Operation |
|-------------------------------------|---------------------------------------------------------------------------------------------------------------------------------|
| Set the time zone (region name) | Press Tab to select the item in the top row of Time Zone, and then use the rotary knob to select the region name. |
| Set the time zone (city name) | Press Tab to select the item in the bottom row of Time Zone, and then use the rotary knob to select the city name. |
| Set the year, month, day, and time. | Press Tab to select the year, month, day, or time of Date & Time, and use the numeric keypad or rotary knob to enter the value. |

3 Press Apply.

This completes the setting.

Factory Default Settings and Reset Settings

The PLZ-5W provides “factory default settings” and “reset settings” as default settings.

Restoring the factory default settings

Restoring the factory default settings deletes all the user data*.

For details about the factory default setting, see “Main settings at factory default and at reset” (p. 123).

*: The user data is deleted in accordance with the NISPOM (National Industrial Security Program Operating Manual) standard.

You can also return only the interface settings to their factory default values (p. 118).

1 Press SYSTEM, Admin, and then Sanitize.

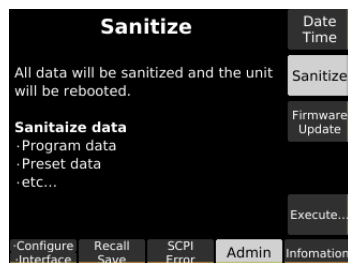

2 Press Execute.

A confirmation screen appears.

3 Use the rotary knob to select OK, and then press ENTER.

The PLZ-5W restarts, and the factory default settings are restored.

Restoring the reset settings

You can reset some of the settings to their factory defaults at power-on.

For the items that are reset, see “Main settings at factory default and at reset” (p.123).

You can also reset only the interface settings (p.117).

1 Press SYSTEM.

If the Configure screen does not appear, press Configure.

2 Use the rotary knob to select Power on, and then press Edit.

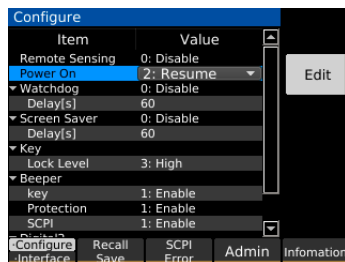

3 Use the rotary knob to select RST, and then press ENTER.

4 Turn the PLZ-5W off and then back on.

The PLZ-5W restarts with some of the settings reset to their factory defaults.

Main settings at factory default and at reset

The main settings at factory default and at reset, for each of the settings that can be done with the SOURCE key, MEASURE key, SEQUENCE key, and SYSTEM key, are listed below.

All items that have the ✓ mark in the “Reset” column are returned to their factory default values upon reset.

SOURCE function settings

| Item | Factory default | | | Reset | |
|--------------------------------------------------|------------------------------------------------|-----------|-----------|--------|---|
| | PLZ205W | PLZ405W | PLZ1205W | | |
| Operation mode | CC | | | ✓ | |
| Current | 0 A | | | ✓ | |
| Conductance | 0 S | | | ✓ | |
| Voltage | 0 V | | | ✓ | |
| Power | 0 W | | | ✓ | |
| Current range | H range | | | ✓ | |
| Voltage range | H range | | | ✓ | |
| Trigger source | Immediate | | | ✓ | |
| Response speed in CR mode | Normal | | | ✓ | |
| Response speed in CV mode | Normal | | | ✓ | |
| Soft start time | OFF | | | ✓ | |
| Auto load off timer | OFF | | | ✓ | |
| External control | CC/CR/CP mode | Disable | | ✓ | |
| | CV mode | Disable | | ✓ | |
| | CC Add | Disable | | ✓ | |
| | Input Logic | Positive | | ✓ | |
| Switching | Current (Depth) | 0 A | | ✓ | |
| | Conductance (Depth) | 0 S | | ✓ | |
| | Duty cycle | 50 % | | ✓ | |
| | Frequency | 1 Hz | | ✓ | |
| Slew rate | 0.01 A/μs | 0.02 A/μs | 0.06 A/μs | ✓ | |
| Protection functions | Overcurrent protection setting | 44 A | 88 A | 264 A | ✓ |
| | Operation at overcurrent protection activation | Limit | | | ✓ |
| | Overpower protection setting | 220 W | 440 W | 1320 W | ✓ |
| | Operation at overpower protection activation | Limit | | | ✓ |
| | Undervoltage protection | OFF | | | ✓ |
| Short function | OFF | | | ✓ | |
| Number of data points of I-V characteristics map | 3 | | | ✓ | |

MEASURE function settings

| Item | | Factory default | Reset |
|------------------------------------|----------------------------------------------------------------|-----------------|-------|
| Measurement function | Number of measurement values to be recorded | 1 | ✓ |
| | Delay | 0 s | ✓ |
| | Measurement interval function (Interval) | Disable | ✓ |
| | Measurement interval time (Interval Time) | 0.1 s | ✓ |
| | Trigger source | Immediate | ✓ |
| | Measurement time (Sense Aperture) | 0.1 s | ✓ |
| Integrated data recording function | Integrated data recording period (Integral Gate) | Load On | ✓ |
| | Resetting of integrated data before start of recording (Reset) | Auto | ✓ |
| Integrated data display | Elapsed time | Disable | ✓ |
| | Capacity | Disable | ✓ |
| | Energy | Disable | ✓ |

SEQUENCE function settings

| Item | | Factory default | Reset |
|-------------------|--|-----------------|-------|
| Program | | No program | – |
| Program selection | | No selection | ✓ |

SYSTEM function settings

| Item | | Factory default | Reset |
|---------------------------------------------------|------------------------------------|-----------------|-------|
| Remote sensing | | Disable | – |
| Panel settings at startup (Power On) | | Resume | – |
| Watchdog protection function | | Disable | – |
| Set time for watchdog protection function (Delay) | | 60 s | – |
| Screen saver | | Disable | – |
| Screen saver startup time (Delay) | | 60 s | – |
| Key lock level | | High | – |
| Beep sound | In case of invalid operation (Key) | Enable | – |
| | In case of alarm activation | Enable | – |
| | In case of SCPI error | Enable | – |
| I/O direction of DIGITAL2 signal | | Input | – |
| Time zone | | UTC*1 | – |

*1. If reset to the factory default value, set the date and time ([p. 120](#)).

For details on the factory default settings and reset settings for the interface, see “Displaying/Changing the Interface Settings” ([p. 116](#)).

Updating

You can update the PLZ-5W firmware by using a USB memory device.

If there is an update, you can obtain it from the download service on the Kikusui website (<http://www.kikusui.co.jp/en/download/>).

NOTE

Save the update files (Update.img, CHECKSUM.md5) in the root directory of the USB memory device. Do not change the names of the update files.

1 Press SYSTEM, Admin, and then Firmware Update.

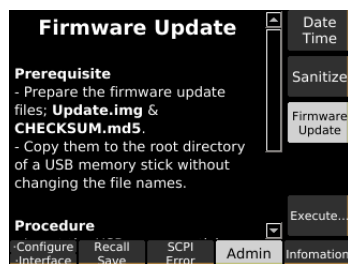

2 Insert the USB memory device on which the update files have been saved into the USB port on the front panel, and then press Execute.

An update screen appears.

3 Press ENTER.

Do not turn off the POWER switch while updating is in progress. Do not remove the USB memory device.

When updating is complete, the PLZ-5W restarts. After restart, remove the USB memory device.

Updating is complete.

Displaying the Device Information

You can display the model name, serial number, firmware version, IP address, and other device information.

1 Press **SYSTEM** and then **Information**.

The device information is displayed. You can scroll the screen by turning the rotary knob.

If a connection is established when IP Address > Method is set to Automatic in the interface settings (p.116) (the LAN connection status icon in the upper right of the display is green), the automatically assigned IP address is displayed next to IP Address.

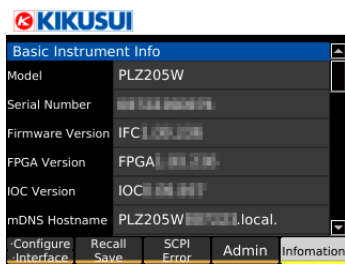

Maintenance

Inspection

To purchase accessories or options, contact your Kikusui agent or distributor.

Overhaul

The electrolytic capacitors and fan motor inside the PLZ-5W are consumable parts.

We recommend that you have the PLZ-5W overhauled every 10000 operating hours or so (the frequency depends on the usage conditions), along with internal inspection and cleaning. To have your unit overhauled, contact your Kikusui agent or distributor.

Backup battery replacement

The PLZ-5W has a battery inside. The battery's service life differs depending on the environment that the PLZ-5W is used in, but three years after it is purchased is a rough estimate for the battery's service life. When the battery is exhausted, the time becomes inaccurate. For information about replacing the battery, contact your Kikusui agent or distributor.

Calibration

The PLZ-5W is calibrated before shipment. To maintain long-term performance, we recommend periodic calibration. To have your PLZ-5W calibrated, contact your Kikusui agent or distributor.

Specifications

Unless specified otherwise, the specifications are for the following settings and conditions.

- The product is warmed up for at least 30 minutes.
- The specifications of the PLZ-5W are for the load input terminals on the rear panel.

The used terminology is as follows:

- TYP: These are typical values that are representative of situations where the product operates in an environment with an ambient temperature of 23 °C. They are not guaranteed performance values.
- set: Indicates a setting.
- range: Indicates the rated value of each range.
- Values indicated by “reading” are readings.

Ratings

| Item | PLZ205W | PLZ405W | PLZ1205W |
|-----------------------------------------|-------------------------------|---------|-------------------------------------------------------------------------------|
| Operating voltage (DC) | 0.25 V to 150 V* ¹ | | |
| Current* ² | 40 A | 80 A | 240 A (80 A* ³ for the load input terminals on the front panel) |
| Power | 200 W | 400 W | 1200 W |
| Input resistance when the load is off | Approx. 660 kΩ* ⁴ | | |
| Load input terminal's isolation voltage | ±500 V | | |

*1. In switching mode, for every slew rate setting of 1 A/μs, the minimum operating voltage (including the voltage drop due to the wiring inductance component) increases by approx. 150 mV for the PLZ205W, approx. 125 mV for the PLZ405W, and approx. 75 mV for the PLZ1205W.

*2. When the input voltage is 1 V or less, the current is reduced by 10% per 0.1 V.

*3. The specifications of the PLZ-5W are for the load input terminals on the rear panel and the load input terminals on the front panel may not meet the specifications.

*4. In the case of parallel operation using the same models, approx. 660/number of units kΩ.

Constant current (CC) mode

| Item | | PLZ205W | PLZ405W | PLZ1205W | |
|-------------------------------------|--------------------|------------------------------------------------------|------------------------------------------------------|---------------|--|
| Operating range | H range | 0 A to 40 A | 0 A to 80 A | 0 A to 240 A | |
| | M range | 0 A to 4 A | 0 A to 8 A | 0 A to 24 A | |
| | L range | 0 A to 0.4 A | 0 A to 0.8 A | 0 A to 2.4 A | |
| Setting range | H range | 0 A to 42 A | 0 A to 84 A | 0 A to 252 A | |
| | M range | 0 A to 4.2 A | 0 A to 8.4 A | 0 A to 25.2 A | |
| | L range | 0 A to 0.42 A | 0 A to 0.84 A | 0 A to 2.52 A | |
| Resolution | H range | 1 mA | 2 mA | 5 mA | |
| | M range | 0.1 mA | 0.2 mA | 0.5 mA | |
| | L range | 0.01 mA | 0.02 mA | 0.05 mA | |
| Setting accuracy | H range | $\pm(0.2\% \text{ of set} + 0.1\% \text{ of range})$ | | | |
| | M range | $\pm(0.2\% \text{ of set} + 0.3\% \text{ of range})$ | | | |
| | L range | $\pm(0.2\% \text{ of set} + 1\% \text{ of range})$ | | | |
| | Parallel Operation | H range | $\pm(0.4\% \text{ of set} + 0.8\% \text{ of range})$ | | |
| | | M range | $\pm(0.4\% \text{ of set} + 0.8\% \text{ of range})$ | | |
| | | L range | $\pm(0.4\% \text{ of set} + 5\% \text{ of range})$ | | |
| Input line regulation ^{*1} | | 4 mA | 8 mA | 24 mA | |
| Ripple | rms ^{*2} | 4 mA | 8 mA | 24 mA | |
| | p-p ^{*3} | 40 mA | 80 mA | 200 mA | |

*1. When the input voltage is changed from 1 V to 150 V at a current of rated power/150 V

*2. Measurement frequency bandwidth: 10 Hz to 1 MHz

*3. Measurement frequency bandwidth: 10 Hz to 20 MHz

Constant resistance (CR) mode

| Item | | PLZ205W | PLZ405W | PLZ1205W | |
|--------------------------------|--------------------|-----------------------------------------|------------------------------------------|---------------------------------------------|--|
| Operating range ^{*1} | H range | 40 S to 0.002 S (0.025 Ω to 500 Ω) | 80 S to 0.004 S (0.0125 Ω to 250 Ω) | 240 S to 0.012 S (0.0042 Ω to 83.333 Ω) | |
| | M range | 4 S to 0.0002 S (0.25 Ω to 5000 Ω) | 8 S to 0.0004 S (0.125 Ω to 2500 Ω) | 24 S to 0.0012 S (0.042 Ω to 833.33 Ω) | |
| | L range | 400 mS to 0.02 mS (2.5 Ω to 50000 Ω) | 800 mS to 0.04 mS (1.25 Ω to 25000 Ω) | 2400 mS to 0.12 mS (0.42 mΩ to 8333.3 Ω) | |
| Setting range | H range | 42 S to 0 S (0.0238 Ω to Open) | 84 S to 0 S (0.0119 Ω to Open) | 252 S to 0 S (0.00397 Ω to Open) | |
| | M range | 4.2 S to 0 S (0.238 Ω to Open) | 8.4 S to 0 S (0.119 Ω to Open) | 25.2 S to 0 S (0.0397 Ω to Open) | |
| | L range | 420 mS to 0 S (2.38 Ω to Open) | 840 mS to 0 S (1.19 Ω to Open) | 2520 mS to 0 S (0.397 Ω to Open) | |
| Resolution | H range | 1 mS | 2 mS | 5 mS | |
| | M range | 0.1 mS | 0.2 mS | 0.5 mS | |
| | L range | 0.01 mS | 0.02 mS | 0.05 mS | |
| Setting accuracy ^{*2} | H range | ±(0.5 % of set + 0.5 % of range) | | | |
| | M range | ±(0.5 % of set + 0.5 % of range) | | | |
| | L range | ±(0.5 % of set + 1.5 % of range) | | | |
| | Parallel Operation | H range | ±(0.5 % of set + 1.5 % of range) | | |
| | | M range | ±(0.5 % of set + 1.5 % of range) | | |
| | | L range | ±(0.5 % of set + 5 % of range) | | |

*1. Conductance [S] = input current [A]/input voltage [V] = 1/resistance [Ω]

*2. Converted value at the input current. At the sensing terminals during remote sensing.

Constant voltage (CV) mode

| Item | | PLZ205W | PLZ405W | PLZ1205W |
|---------------------------------------|--------------------|----------------------------------|---------|----------|
| Operating range | H range | 0.25 V to 150 V | | |
| | L range | 0.25 V to 15 V | | |
| Setting range | H range | 0 V to 157.5 V | | |
| | L range | 0 V to 15.75 V | | |
| Resolution | H range | 5 mV | | |
| | L range | 0.5 mV | | |
| Setting accuracy ^{*1} | | ±(0.1 % of set + 0.1 % of range) | | |
| | Parallel Operation | ±(0.2 % of set + 0.2 % of range) | | |
| Input current variation ^{*2} | | 12 mV | | |

*1. With the input voltage within the operating range, and at the sensing terminals during remote sensing.

*2. For a current change in the range of 10 % to 100 % of the rating at an input voltage of 5 V (during remote sensing).

Constant power (CP) mode

| Item | | PLZ205W | PLZ405W | PLZ1205W |
|---------------------|---------|---------------------------------------------------------------------------|----------------------------------------------------------------|----------------------------------------------------------------|
| Operating range | H range | 20 W to 200 W | 40 W to 400 W | 120 W to 1200 W |
| | M range | 2 W to 20 W | 4 W to 40 W | 12 W to 120 W |
| | L range | 0.2 W to 2 W | 0.4 W to 4 W | 1.2 W to 12 W |
| Setting range | H range | 0 W to 210 W | 0 W to 420 W | 0 W to 1260 W |
| | M range | 0 W to 21 W | 0 W to 42 W | 0 W to 126 W |
| | L range | 0 W to 2.1 W | 0 W to 4.2 W | 0 W to 12.6 W |
| Resolution | H range | 0.005 W | 0.01 W | 0.05 W |
| | M range | 0.0005 W | 0.001 W | 0.005 W |
| | L range | 0.00005 W | 0.0001 W | 0.0005 W |
| Setting accuracy *1 | H range | $\pm(0.5 \% \text{ of range} + 0.04 \text{ A} \times V_{in})$ | $\pm(0.5 \% \text{ of range} + 0.08 \text{ A} \times V_{in})$ | $\pm(0.5 \% \text{ of range} + 0.24 \text{ A} \times V_{in})$ |
| | M range | $\pm(0.5 \% \text{ of range} + 0.008 \text{ A} \times V_{in})$ | $\pm(0.5 \% \text{ of range} + 0.016 \text{ A} \times V_{in})$ | $\pm(0.5 \% \text{ of range} + 0.048 \text{ A} \times V_{in})$ |
| | L range | $\pm(1 \% \text{ of range} + 0.004 \text{ A} \times V_{in})$ | $\pm(1 \% \text{ of range} + 0.008 \text{ A} \times V_{in})$ | $\pm(1 \% \text{ of range} + 0.024 \text{ A} \times V_{in})$ |
| Parallel Operation | H range | $\pm(2 \% \text{ of range} + 0.4 \% \text{ current range} \times V_{in})$ | | |
| | M range | $\pm(2 \% \text{ of range} + 0.4 \% \text{ current range} \times V_{in})$ | | |
| | L range | $\pm(2 \% \text{ of range} + 2.5 \% \text{ current range} \times V_{in})$ | | |

*1. V_{in} : Rear panel load input terminal voltage or sensing terminal voltage.

Arbitrary I-V characteristics (ARB) mode

| Item | PLZ205W | PLZ405W | PLZ1205W |
|-----------------|-----------------------------------------------------------------------------------------------------------------------------------------|---------|----------|
| Operating range | Three to 100 points of current values can be specified for the input voltage. Linear interpolation is applied between specified points. | | |
| Response speed | 50 μs minimum for the input voltage | | |

Measurement function

Voltmeter

| Item | | PLZ205W | PLZ405W | PLZ1205W |
|----------|--------------------------|------------------------------------------------------------|---------|----------|
| Display | H range | 0.00 V to 150.00 V | | |
| | L range | 0.000 V to 15.000 V | | |
| Accuracy | | $\pm(0.1 \% \text{ of reading} + 0.1 \% \text{ of range})$ | | |
| | Parallel operation (TYP) | $\pm(0.1 \% \text{ of reading} + 0.1 \% \text{ of range})$ | | |

Ammeter

| Item | | PLZ205W | PLZ405W | PLZ1205W |
|--------------------------|------------------|----------------------------------------------------------|----------------------|----------------------|
| Display | H range | 0.000 A to 40.000 A | 0.000 A to 80.000 A | 0.00 A to 240.00 A |
| | M range | 0.0000 A to 4.0000 A | 0.0000 A to 8.0000 A | 0.000 A to 24.000 A |
| | L range | 0.00 mA to 400.00 mA | 0.00 mA to 800.00 mA | 0.0000 A to 2.4000 A |
| Accuracy | H range, M range | $\pm(0.2\% \text{ of reading} + 0.3\% \text{ of range})$ | | |
| | L range | $\pm(0.2\% \text{ of reading} + 1\% \text{ of range})$ | | |
| Parallel Operation (TYP) | H range, M range | $\pm(0.4\% \text{ of reading} + 0.8\% \text{ of range})$ | | |
| | L range | $\pm(0.4\% \text{ of reading} + 5\% \text{ of range})$ | | |

Power display

| Item | PLZ205W | PLZ405W | PLZ1205W |
|---------|--------------------------------------------------------------------|---------|----------|
| Display | Displays the product of the voltmeter reading and ammeter reading. | | |

Switching function

| Item | | PLZ205W | PLZ405W | PLZ1205W |
|----------------------------------------------|---------------------|------------------------------|---------|----------|
| Operation mode | | CC and CR | | |
| Frequency setting range | | 1.0 Hz to 100.0 kHz | | |
| Frequency setting resolution | 1 Hz to 10 Hz | 0.1 Hz | | |
| | 11 Hz to 100 Hz | 1 Hz | | |
| | 110 Hz to 1000 Hz | 10 Hz | | |
| | 1.1 kHz to 10.0 kHz | 0.1 kHz | | |
| | 10 kHz to 100 kHz | 20 kHz, 50 kHz, 100 kHz | | |
| Frequency setting accuracy | | $\pm(0.5\% \text{ of set})$ | | |
| Duty cycle setting range, step ^{*1} | 1 Hz to 10 Hz | 5.0 % to 95.0 %, 0.1 % steps | | |
| | 11 Hz to 100 Hz | | | |
| | 110 Hz to 1000 Hz | | | |
| | 1.1 kHz to 10.0 kHz | 5 % to 95 %, 1 % steps | | |
| | 10 kHz to 100 kHz | 10 % to 90 %, 10 % steps | | |

*1. The minimum time span is 5 μ s. The minimum duty cycle is limited by the minimum time span.

Slew rate

| Item | | PLZ205W | PLZ405W | PLZ1205W |
|--------------------------------|------------------|------------------------------------|------------------------------------|------------------------------------|
| Operation mode | | CC | | |
| Setting range | H range | 0.01 A/ μ s to 10 A/ μ s | 0.02 A/ μ s to 20 A/ μ s | 0.06 A/ μ s to 60 A/ μ s |
| | M range | 0.001 A/ μ s to 1 A/ μ s | 0.002 A/ μ s to 2 A/ μ s | 0.006 A/ μ s to 6 A/ μ s |
| | L range | 0.1 mA/ μ s to 100 mA/ μ s | 0.2 mA/ μ s to 200 mA/ μ s | 0.6 mA/ μ s to 600 mA/ μ s |
| Resolution | H range | 0.01 A/ μ s | 0.02 A/ μ s | 0.06 A/ μ s |
| | M range | 0.001 A/ μ s | 0.002 A/ μ s | 0.006 A/ μ s |
| | L range | 0.1 mA/ μ s | 0.2 mA/ μ s | 0.6 mA/ μ s |
| Setting accuracy ^{*1} | H range, M range | \pm (10 % of set +1.25 μ s) | | |
| | L range | \pm (12 % of set +5 μ s) | | |

*1. Time to change from 10 % to 90 % when the current is changed from 0 % to 100 % of the rated current

Soft start

| Item | PLZ205W | PLZ405W | PLZ1205W |
|-----------------------|-------------------------------------------------------------------------------|---------|----------|
| Operation mode | CC | | |
| Time setting range | 100 μ s, 200 μ s, 500 μ s, 1 ms, 2 ms, 5 ms, 10 ms, 20 ms, or off | | |
| Time setting accuracy | \pm (30 % of set +10 μ s) | | |

Alarm Function

Alarm 1

| Item | PLZ205W | PLZ405W | PLZ1205W |
|-------------------------------------------------------|--------------------------------------------------------------------------------------------------------------------------------------------------------------------------------------------------------|---------|----------|
| Overvoltage detection | Turns off the load when a voltage that is 110 % or higher of the range's rating is applied. | | |
| Reverse-connection detection | Turns off the load when a reverse voltage (-0.6 V) is applied to the load input terminals or when a reverse current (approx. -1 % of range rating) flows. | | |
| Overheat detection | Turns off the load when the heatsink temperature reaches 100 °C | | |
| Alarm input detection | Turns off the load when a voltage between 0 V and 1.5 V is applied to ALARM INPUT (pin 10) of the EXT CONT connector. | | |
| Parallel operation anomaly detection | Turns off the load in parallel operation mode when an anomaly occurs during communication, when the slave unit's power supply is interrupted, or when the slave unit's overheat detection is activated | | |
| Front-panel load input terminal overcurrent detection | Turns off the load when a current of 80 A or higher is flowing through the front panel load input terminals | | |

Alarm 2

| Item | | PLZ205W | PLZ405W | PLZ1205W |
|-------------------------------|----------------------|-----------------------------------------------|-----------------|------------------|
| Overcurrent protection (OCP) | Setting range | 0.0 A to 44.0 A | 0.0 A to 88.0 A | 0.0 A to 264.0 A |
| | Resolution | 10 mA | 10 mA | 10 mA |
| | Protection operation | Either load off or limitation can be selected | | |
| Overpower protection (OPP) | Setting range | 0 W to 220 W | 0 W to 440 W | 0 W to 1320 W |
| | Resolution | 0.1 W | 0.1 W | 0.1 W |
| | Protection operation | Either load off or limitation can be selected | | |
| Undervoltage protection (UVP) | Setting range | 0.00 V to 150.00 V, or off. | | |
| | Resolution | 0.01 V | | |
| | Protection operation | Load off | | |
| Watchdog protection (WDP) | Setting range | 1 s to 3600 s or off | | |
| | Protection operation | Load off | | |

Sequence function

| Item | PLZ205W | PLZ405W | PLZ1205W |
|----------------------------|-----------------|---------|----------|
| Operation mode | CC, CR, CV, CP | | |
| Maximum number of programs | 30 | | |
| Maximum number of steps | 10000 | | |
| Step execution time | 25 µs to 1000 h | | |
| Time resolution | 25 µs | | |

Other functions

| Item | | PLZ205W | PLZ405W | PLZ1205W |
|----------------------------------------------|---------------|---------------------------------------------------------------------------------------------|---------|-----------------------------------|
| Possible remote sensing compensation voltage | | Approx. 7 V (total potential difference between the input terminals and sensing terminals). | | |
| Number of units in parallel operation | Same model | 5 units | 5 units | 5 units |
| | Booster | — | — | PLZ1205W: 1 PLZ2405WB: 4 units |
| Mutual synchronized operation | | Synchronization of load on/off, measurement, sequence execution, and sequence resumption. | | |
| Elapsed time display | | Displays the time from load on to load off. | | |
| | Range | 1 s to 999 h 59 min 59 s. | | |
| Integrated current display | | Displays the integrated current from load on to load off. | | |
| Integrated power display | | Displays the integrated power from load on to load off. | | |
| Auto load off timer | | Automatically turns off the load after the specified time elapses. | | |
| | Setting range | 1 s to 3599999 s or off. | | |

Common specifications

EXT CONT connector

| Item | Specifications |
|-----------------------------------------------------------|-------------------------------------------------------------------------------------------------------------------------------------------------------------------------------------------------------------------------------------------------------------------------------------------------------------------------------------------------------------------------------------------------------------------------------------------------------------------------------------------------------------------------------------------|
| Load on/off control input | Logic level switchable. Pulled up to 5 V by a 10 kΩ resistor. The thresholds are HIGH: 3.5 V to 5 V, LOW: 0 V to 1.5 V. |
| Range control input | The range can be switched between L, M, and H using a 2 bit signal. Pulled up to 5 V by a 10 kΩ resistor. The thresholds are HIGH: 3.5 V to 5 V, LOW: 0 V to 1.5 V. |
| Alarm input | An alarm is activated with a voltage between 0 V and 1.5 V. Pulled up to 5 V by a 10 kΩ resistor. The thresholds are HIGH: 3.5 V to 5 V, LOW: 0 V to 1.5 V. |
| Alarm clearing input | After an alarm occurs, eliminate the root cause of the alarm, and change the input to pin 5 of the EXT CONT connector from a low level signal to a high level signal. The alarm will be cleared on the rising edge of this signal. Pulled up to 5 V by a 10 kΩ resistor. The thresholds are HIGH: 3.5 V to 5.0 V, LOW: 0 V to 1.5 V. |
| Trigger input | Paused sequence operation resumes when a voltage between 0 V and 0.8 V is received. Pulled up to 5 V by a 10 kΩ resistor. The thresholds are HIGH: 2 V to 5 V, LOW: 0 V to 0.8 V. |
| External voltage control input (CC, CR, CP mode) | Controls the load settings of CC, CR, CP mode through external voltage input. The input impedance is approx. 10 kΩ. CC: The setting can be controlled in the range of 0 % to 100 % of the rated current through external voltage input of 0 V to 10 V. CR: The setting can be controlled in the range of 0 % to 100 % of the conductance setting through external voltage input of 0 V to 10 V. CP: The setting can be controlled in the range of 0 % to 100 % of the rated power through external voltage input of 0 V to 10 V. |
| Setting accuracy | ±(1 % of range) (TYP value of H range in CC mode) |
| External voltage control input (CV mode) | The load setting of CV mode can be controlled through external voltage input. The rated voltage can be controlled in the range of 0 % to 100 % with 0 V to 10 V. The input impedance is approx. 10 kΩ. |
| Setting accuracy | ±(1 % of range) (TYP value) |
| External voltage control input (superimposing in CC mode) | Controls the load setting of CC mode by adding current through external voltage input. Adds current in the range of -100 % to 100 % of the rated current for -10 V to 10 V. The input impedance is approx. 10 kΩ. |
| Setting accuracy | ±(1 % of range) (TYP value of H range) |
| Load-on status output | On when load is on. Open-collector output from a photocoupler.*1 |
| Range status output | Outputs current range state L, M, and H using 2 bits. Open-collector output from a photocoupler.*1 |
| ALARM 1 output | Turns on when overvoltage detection, reverse-connection detection, overheat detection, alarm input detection, front-panel load input terminal overcurrent detection, or parallel operation anomaly detection is activated. Open-collector output from a photocoupler.*1 |
| ALARM 2 output | Turns on when OCP, OPP, UVP, or WDP is activated. |
| DIGITAL 0 output | Logic signal output during a step of a sequence. |
| DIGITAL 1 output | Output impedance: approx. 330 Ω, output voltage: 3.3 V _{EMF} |
| DIGITAL 2 input/output | Input/output switchable. Output: Logic signal output during a step of a sequence. The output impedance is 330 Ω. Input: Trigger input signal for the sequence and the measurement functions. The thresholds are HIGH: 2 V to 5 V, LOW: 0 V to 0.8 V. |
| Current monitor output | Outputs 0 V to 10 V for 0 % to 100 % of the rated current of each range |
| Accuracy | ±(1 % of range) (TYP value of H range) |
| Short contact output. | Relay contact turns on when the short function is turned on (30 Vdc/1 A). |

*1. The maximum voltage that can be applied to the photocoupler is 30 V. The maximum current is 4 mA.

BNC connector

| Item | Specifications |
|------------------------|----------------------------------------------------------------------------------------------------------------------------------------------------------------------------------------------------------------------------------|
| Trigger output | Transmits 10 μ s pulses during step execution when trigger output is set in a sequence. Transmits 1 μ s pulses during switching operation. Output impedance 200 Ω , output voltage: approx. 5 V _{EMF} |
| Current monitor output | Outputs 0 V to 2 V for 0 % to 100 % of the rated current of each range. |
| Accuracy | \pm (1 % of range) (TYP value of H range) |
| Isolation voltage | \pm 30 V |

Communication function

| Item | Specifications | |
|--------------|------------------------|--------------------------------------------------------------------------------------------------------------------------------------------------------------|
| RS232C | Hardware | D-SUB 9-pin connector. Baud rate: 9600, 19200, 38400, 115200 bps. Data length: 8 bits, Stop bits: 1 bit, Parity bit: None Flow control: No, CTS-RTS |
| | Message terminator | LF during reception, LF during transmission. |
| USB (device) | Hardware | Standard type B socket. Complies with the USB 2.0 specification. Data rate: 480 Mbps (High Speed). |
| | Message terminator | LF or EOM during reception, LF + EOM during transmission. |
| | Device class | Complies with the USBTMC-USB488 device class specifications. |
| USB (host) | Hardware | Standard type A socket Complies with the USB 2.0 specifications. Data rate: 12 Mbps (Full speed). |
| LAN | Hardware | IEEE 802.3 100Base-TX/10Base-T Ethernet Auto-MDIX support. IPv4, RJ-45 connector. |
| | Compliant standards | LXI 1.4 Core Specification 2011 |
| | Communication protocol | VXI-11, HiSLIP, SCPI-RAW, SCPI-Telnet |
| | Message terminator | VXI-11, HiSLIP: LF or END during reception, LF + END during transmission. SCPI-RAW: LF during reception, LF during transmission. |

General specifications

| Item | PLZ205W | PLZ405W | PLZ1205W |
|-----------------------------------------------------|--------------------------------------------------------------------------------------------------------------------------------------------------------------------------------------------------------------------------------------------------------------------------------------------------------------------------------------------------------------------------------------------------------------------|---------------------------------------------------------------|-----------------------------|
| Input voltage range | 100 Vac to 240 Vac (90 Vac to 250 Vac) single phase | | |
| Input frequency range | 47 Hz to 63 Hz | | |
| Power consumption | 50 VAmax | 50 VAmax | 85 VAmax |
| Inrush current (peak value) | 45 A | | |
| Environmental conditions | Operating temperature range | 0 °C to 40 °C (32 °F to 104 °F) | |
| | Operating humidity range | 20 %rh to 85 %rh (no condensation) | |
| | Storage temperature range: | -20 °C to 70 °C (-4 °F to 158 °F) | |
| | Storage humidity range: | 90 %rh or less (no condensation) | |
| | Installation location | Indoor use, altitude of up to 2000 m, overvoltage category II | |
| Insulation resistance | Between primary and input terminals | 500 Vdc, 30 MΩ or more (70 %rh or less) | |
| | Between primary and chassis | | |
| | between input terminals and chassis | | |
| Withstanding voltage | Between primary and input terminals | No abnormalities at 1500 Vac for 1 minute. | |
| | Between primary and chassis | No abnormalities at 1500 Vac for 1 minute. | |
| | between input terminals and chassis | No abnormalities at 750 Vac for 1 minute. | |
| Dimensions | See (p.139). | | |
| Weight | Approx. 7 kg (15.4 lb.) | Approx. 7.5 kg (16.5 lb.) | Approx. 14 kg (30.9 lb.) |
| Accessories | See (p.3). | | |
| Electromagnetic compatibility (EMC) ^{*1*2} | <p>Complies with the requirements of the following directive and standards.</p> <p>EMC Directive 2014/30/EU</p> <p>EN 61326-1 (Class A^{*3})</p> <p>EN 55011 (Class A^{*3}, Group 1^{*4})</p> <p>EN 61000-3-2</p> <p>EN 61000-3-3</p> <p>Applicable under the following conditions</p> <p>The maximum length of all cabling and wiring connected to the product must be less than 3 m.</p> | | |
| Safety ^{*1} | <p>Complies with the requirements of the following directive and standards.</p> <p>EMC Directive 2014/35/EU^{*2}</p> <p>EN 61010-1 (Class I^{*5}, Pollution Degree 2^{*6})</p> | | |

*1. Does not apply to specially ordered or modified products.

*2. Only on models that have CE/UKCA marking on the panel.

*3. This is a Class A instrument. This product is intended for use in an industrial environment. This product may cause interference if used in residential areas. Such use must be avoided unless the user takes special measures to reduce electromagnetic emissions to prevent interference to the reception of radio and television broadcasts.

*4. This is a Group 1 instrument. This product does not generate and/or use intentionally radio-frequency energy, in the form of electromagnetic radiation, inductive and/or capacitive coupling, for the treatment of material or inspection/analysis purpose.

*5. This is a Class I instrument. Be sure to ground this product's protective conductor terminal. The safety of this product is guaranteed only when the product is properly grounded.

*6. Pollution is addition of foreign matter (solid, liquid or gaseous) that may produce a reduction of dielectric strength or surface resistivity. Pollution Degree 2 assumes that only non-conductive pollution will occur except for an occasional temporary conductivity caused by condensation.

External dimensions

PLZ205W, PLZ405W

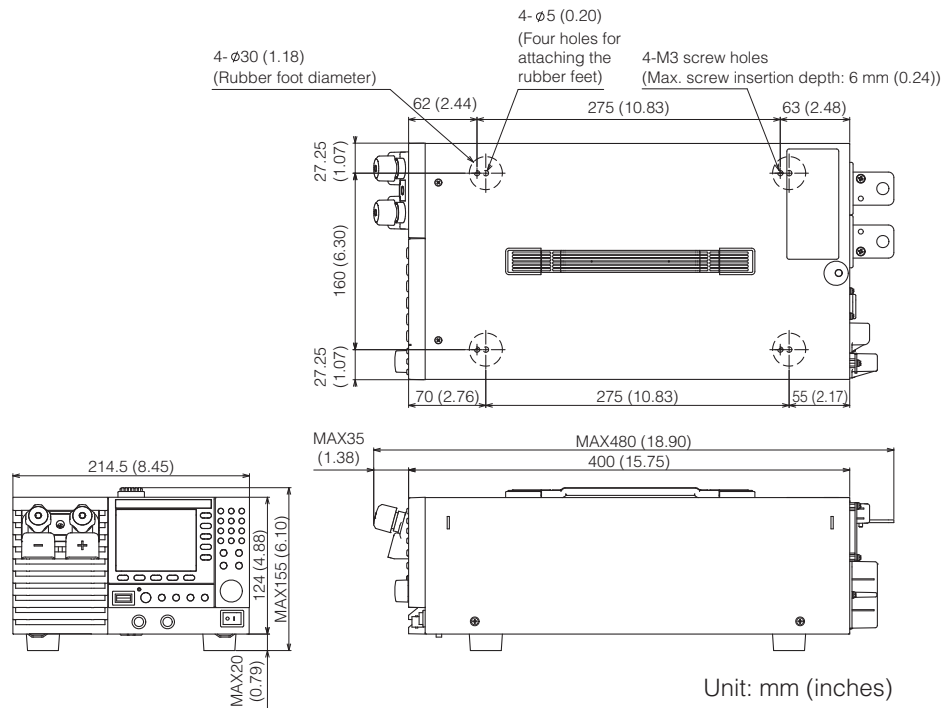

External dimensions (continued)

PLZ1205W

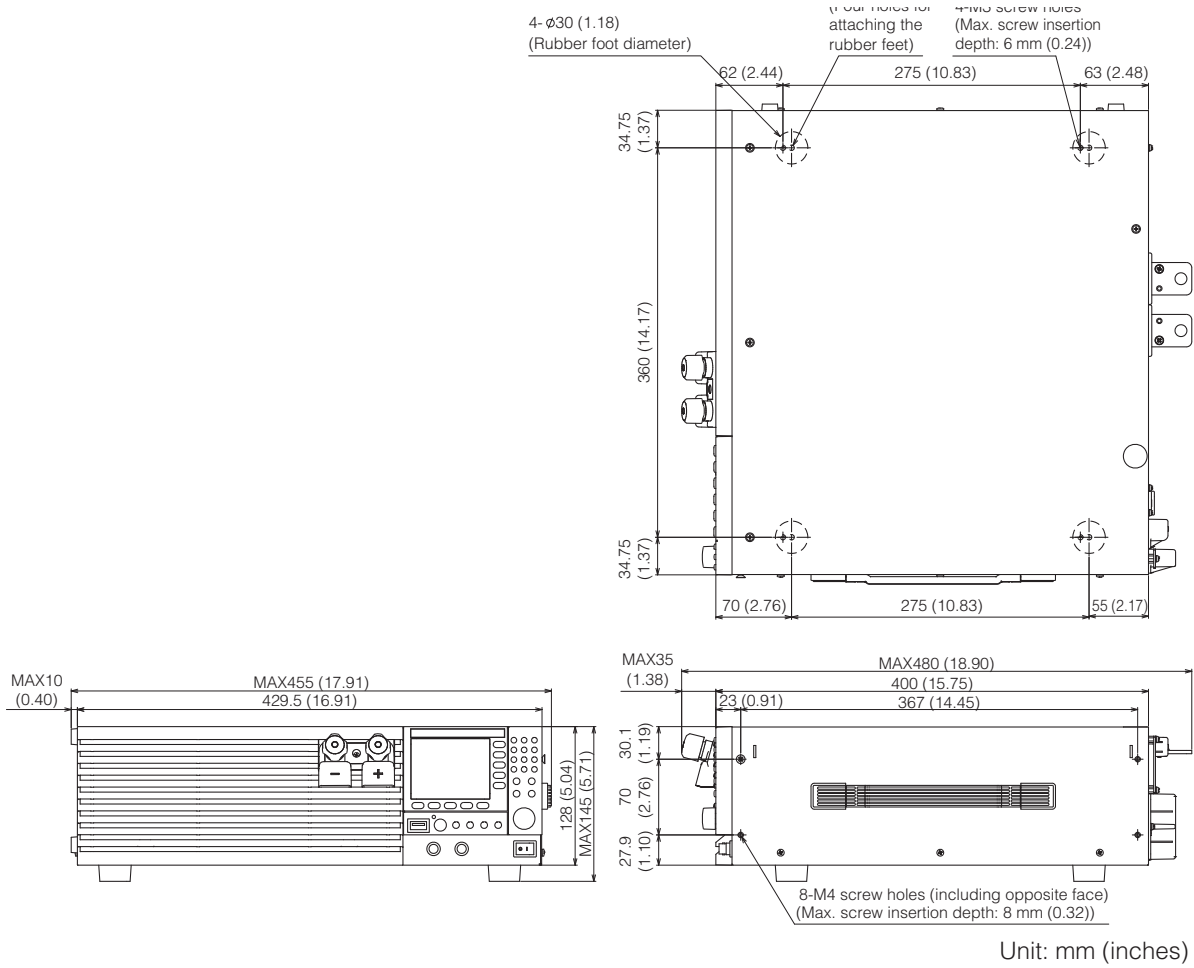

Selecting the Load Cables

WARNING

- Risk of fire. Use load cables whose capacity is adequate for the PLZ-5W's rated input current.
- Risk of electric shock. Use load cables with a voltage rating that meets or exceeds the isolation voltage (± 500 V) of the PLZ-5W's load input terminals.

CAUTION

Use load cables with a core diameter that is appropriate for the amount of current being used and with sturdy, flame-resistant insulation.

■ Current capacity of load cables

If the resistance of the cables used as the load cables is large, a large voltage drop may occur when current flows through the cables. This may result in the load input terminal voltage being lower than the minimum operating voltage of the PLZ-5W. Referring to the table below, select a cable with a nominal cross-sectional area as great as possible.

A cable's temperature is determined by the resistive loss based on the current, the ambient temperature, and the cable's external thermal resistance. The following table shows the current capacity of heat-resistant vinyl cables that have a maximum allowable temperature of 60 °C when one of the cables is separated and stretched out horizontally in air in an ambient temperature of 30 °C. The current must be reduced under certain conditions, such as when vinyl cables that have a low heat resistance are used, when the ambient temperature is 30 °C or greater, or when cables are bundled together and little heat is radiated.

| Nominal cross-sectional area (mm ²) | AWG | (reference cross-sectional area mm ²) | Allowable current* ¹ [A] (Ta = 30 °C) | Kikusui-recommended current (A) |
|-------------------------------------------------|-----|---------------------------------------------------|--------------------------------------------------|---------------------------------|
| 14 | 6 | (13.3) | 88 | 50 |
| 22 | 4 | (21.15) | 115 | 80 |
| 30 | 2 | (33.62) | 139 | - |
| 38 | 1 | (42.41) | 162 | 100 |
| 50 | 1/0 | (53.49) | 190 | - |
| 60 | 2/0 | (67.43) | 217 | - |
| 80 | 3/0 | (85.01) | 257 | 200 |
| 100 | 4/0 | (107.2) | 298 | - |
| 125 | - | - | 344 | - |
| 150 | - | - | 395 | 300 |
| 200 | - | - | 469 | - |
| 250 | - | - | 556 | - |
| 325 | - | - | 650 | - |

*1. Excerpt from Japanese laws related to electrical equipment.

■ Taking measures against noise

When connecting cables that have the same heat resistance, separating the cables as much as possible to increase heat radiation enables a greater amount of current to flow. However, wiring the positive (+) and negative (-) output wires of the load cable side by side or bundling them together is more effective against unwanted noise. The Kikusui-recommended currents shown in the above table are allowable currents that have been reduced in consideration of the potential bundling of load cables. Use these values as a guideline when connecting cables.

■ Limitations of the remote sensing

All wires have resistance. As the wire becomes longer or the current becomes larger, the voltage drop in the wire becomes greater. This results in a smaller voltage being applied at the load input terminal. The PLZ-5W has a sensing function (p.56) that compensates for this voltage drop, which is the total potential difference between the load input terminals and sensing terminals, by up to approximately 7 V. If the voltage drop exceeds this level, use wires that have a greater cross-sectional area.

Methods to Stabilize Operation

Using the PLZ-5W with fast response speed may cause instable oscillation or other operation instability. To achieve stabilization, the load cable inductance must be reduced and an appropriate response speed must be set.

Reducing the load cable inductance

Relationship between voltage induction when current is changed and inductance

Load cables have inductance L . If current I changes quickly, a large voltage is induced on both ends of the installed cables. If the impedance of the DUT is small, this voltage is entirely applied to the load input terminals of the electronic load. The load cable's inductance L and voltage E that is induced according to the changes in current I (hereafter referred to as the induced voltage) are expressed by the following expression:

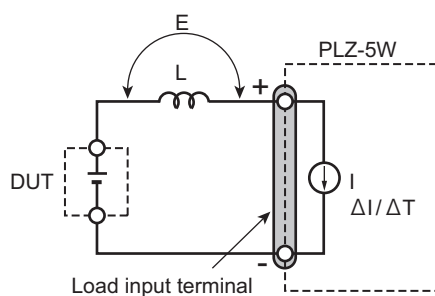

$$E = L \times (\Delta I / \Delta T)$$

- E Induced voltage
- L Wiring inductance
- ΔI Change in current
- ΔT Duration of time over which the current changes

Generally, a cable's inductance is $1 \mu\text{H}$ per meter of cable. If 1 meter of cable (cumulative length of positive (+) polarity cable and negative (-) polarity cable) is used as the load cable between the DUT and electronic load, and the current change is $50 \text{ A}/\mu\text{s}$, the induced voltage is 50 V.

The negative (-) polarity of the load input terminals is the reference potential of the external control signal. Devices connected to external control terminals may malfunction due to the induced voltage.

In constant voltage mode, constant resistance mode, and constant power mode, the load current is varied by the voltage at the load input terminals. This causes the operation to be easily affected by induced voltage.

Preventing large voltage variation when load current changes suddenly

Use the shortest cables possible to connect the PLZ-5W and DUT, and twist the cables. If the load cable is long or has a large loop, the inductance of the wiring will be increased and large voltage variation will occur owing to current changes when the load current changes suddenly.

When the value of instantaneous voltage of the load input terminals drops below the minimum operating voltage, the set slew rate is not realized. You must be careful especially when the slew rate setting is high or when changing the load rapidly using large current.

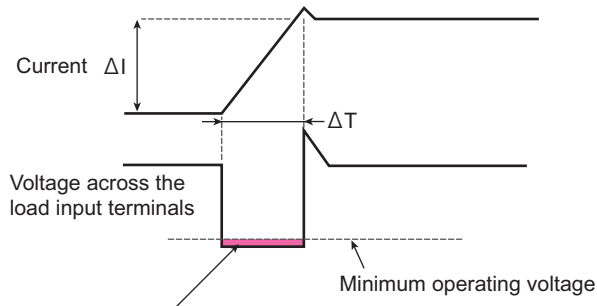

When the value of drops below the minimum operating voltage, the set slew rate is not realized.

Either make the wiring as short as possible so as to keep the voltage resulting from inductance equal to or higher than the minimum operating voltage and within the maximum input voltage range of the PLZ-5W, or reduce the set slew rate. If it is not necessary to operate at a high response speed, reduce the slew rate or reduce the response speed in CC mode or CR mode.

Reducing oscillation caused by phase lag of the current

In CR mode, CV mode, and CP mode, phase lag of the current may cause control of the PLZ-5W to become unstable and oscillation phenomena to occur, even during DC operation. Therefore, use the shortest cables possible and twist them.

If only DC operation is required, a capacitor and a resistor may be connected to the load input terminal to reduce oscillation. Use the capacitor within its allowable ripple current.

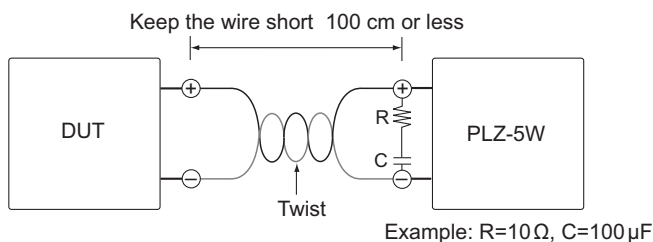

Optimizing the response speed

The current phase is delayed with respect to the voltage due to the inductance of the wiring. Control of the PLZ-5W may become unstable and oscillation phenomena may occur.

If, in CV mode or CR mode, the response speed is set to Fast, stable operation can be secured by setting the response speed to Normal (p.54).

Using remote sensing



Remote sensing ([p.56](#)) can be used to stabilize load current. In CP mode the response speed cannot be specified, but the operation can be stabilized by using remote sensing.

Slew Rate for Small Currents

If the load current is made small in current (CC) mode, the specified slew rate may not be achieved. The following graph shows the current settings versus the logical current rise times and actual current rise times when the slew rate is set to the maximum value in each range.

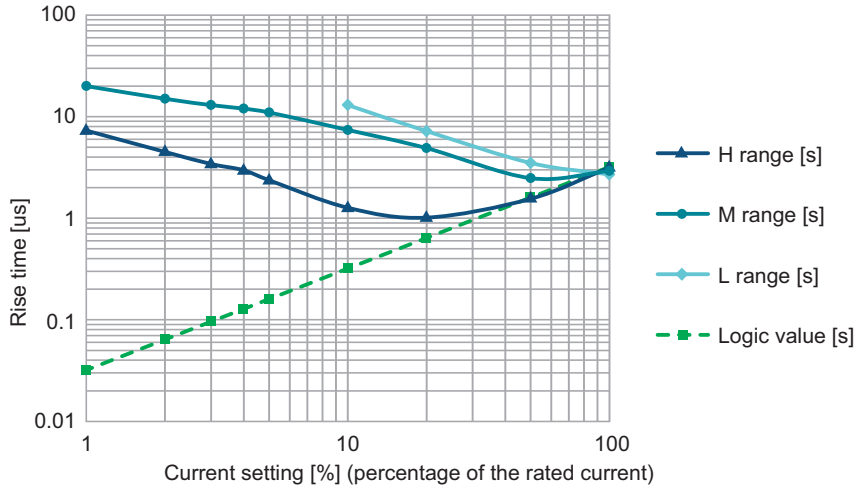

Furthermore, the following graphs show the relationship between the current value and change in current when the slew rate is set to the maximum value for each range.

H range

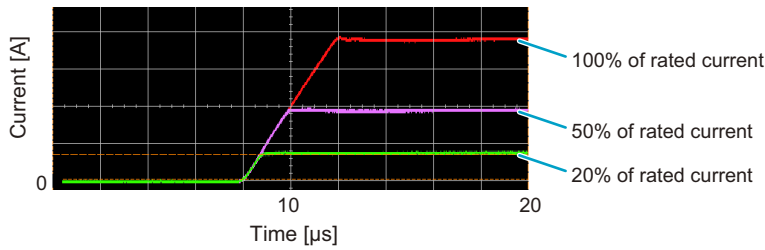

M range

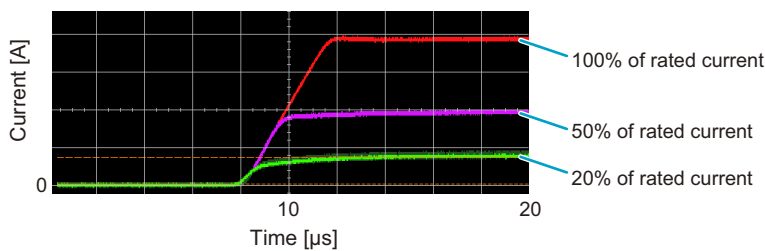

L range

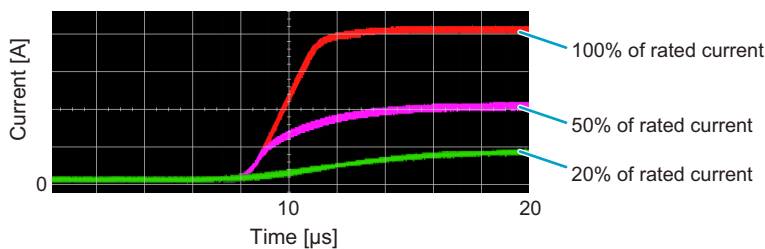

Operating Area

As shown in the figure, the PLZ-5W can be used within the area enclosed by the constant voltage line according to the rated voltage (L1), the constant power line according to the rated power (L2), the constant current line according to the rated current (L3), and the constant voltage line according to the minimum operating voltage (L4). When the input voltage is 1 V or less, the current is reduced by 10% per 0.1 V.

The voltage at which current starts flowing to the PLZ-5W is approximately 0.25 V. If the input voltage is gradually increased from 0 V, no current will flow until the voltage exceeds approximately 0.25 V. If the input voltage exceeds approximately 0.25 V and a current greater than or equal to 1 % (greater than or equal to 1 % of the H range when the PLZ-5W is set using the M range) starts flowing, the current can be kept flowing even when the input voltage is reduced.

For the operating range of each model, refer to “Operating area of each model” (p.157).

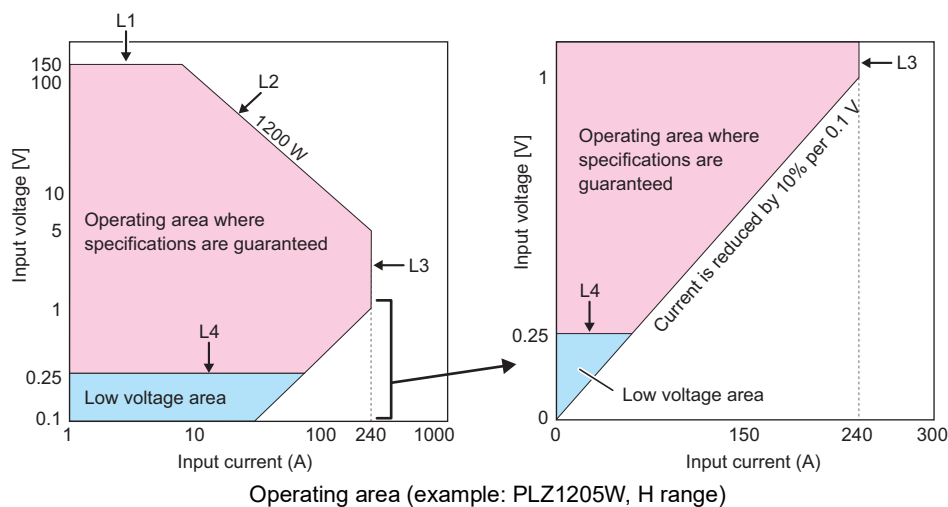

Basic operation modes

The following five operation modes are available on the PLZ-5W.

- Constant current mode (CC mode)
- Constant resistance mode (CR mode)
- Constant power mode (CP mode)
- Constant voltage mode (CV mode)
- Arbitrary I-V characteristics mode (ARB mode)

Operation of the constant current (CC) mode

Operation of the constant current mode

When the PLZ-5W is used in CC mode, the PLZ-5W operates as a constant current load as shown in the following figure. The PLZ-5W sinks specified current I even when output voltage V_1 of the constant-voltage power supply changes.

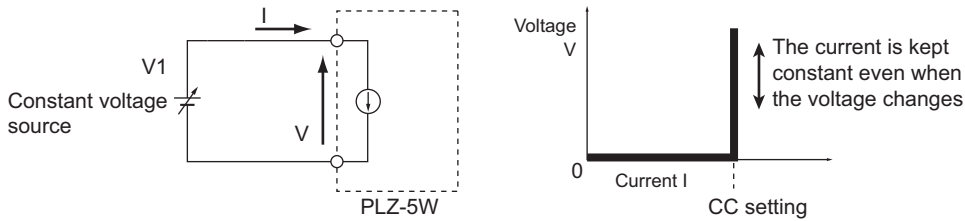

Transition of the operating point: Overpower protection (OPP) operation

Example: Examining the load characteristics of the constant-voltage power supply in CC mode.

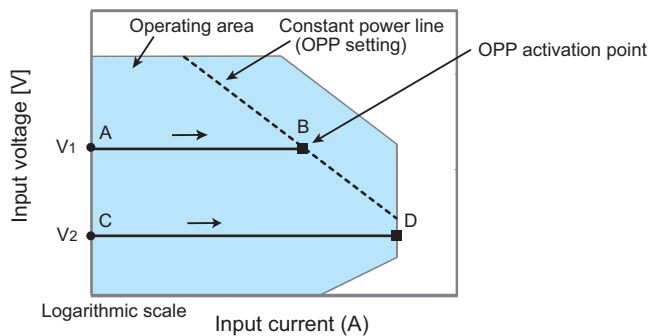

■ Operation on segment AB

If the voltage of the constant-voltage power supply is set to V_1 and the input current (load current) of the PLZ-5W is increased, the operating point moves along segment AB. When point B is reached, overpower protection (OPP) is activated. At this point, two types of operation are available on the PLZ-5W depending on which action is set to be executed at OPP detection.

| Setting | Behavior |
|---------|--------------------------------------------------------------------------------------------------------------------------------------------------------------------------------------------------------------------------------------------------------------------------------------|
| Trip | Turns off the load (stops the current flow). |
| Limit | PLZ-5W sinks current as a constant power load at point B. Even if you attempt to increase the input current, the current is limited at point B. If you decrease the input current, the OPP is cleared. The PLZ-5W returns to CC mode and the operating point moves along segment AB. |

■ Operation on segment CD

If the voltage of the constant-voltage power supply is set to V_2 and the input current (load current) of the PLZ-5W is increased, the operating point moves along segment CD. Point D is the maximum current at the range being used.

Operation in constant resistance (CR) mode

Operation in constant resistance mode

When the PLZ-5W is used in CR mode, the PLZ-5W operates as a constant resistance load as shown in the following figure. When voltage V_1 of the constant-voltage power supply varies, the PLZ-5W sinks current to maintain $I = V/R$, with the specified resistance R fixed. The PLZ-5W operates by sinking current. This mode cannot be used with an AC circuit.

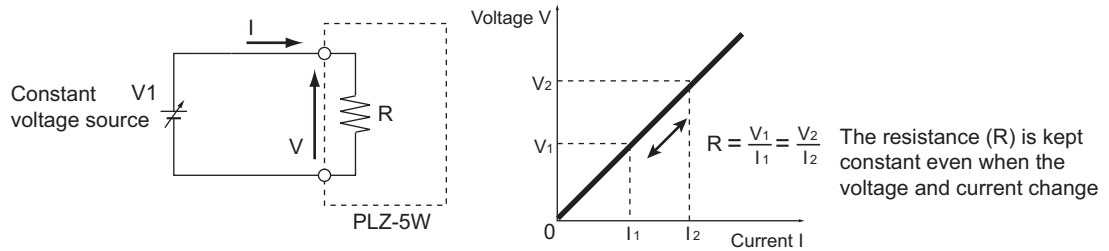

Transition of the operating point: Overpower protection (OPP) operation

Example: Examining the load characteristics of the constant-voltage power supply in CR mode.

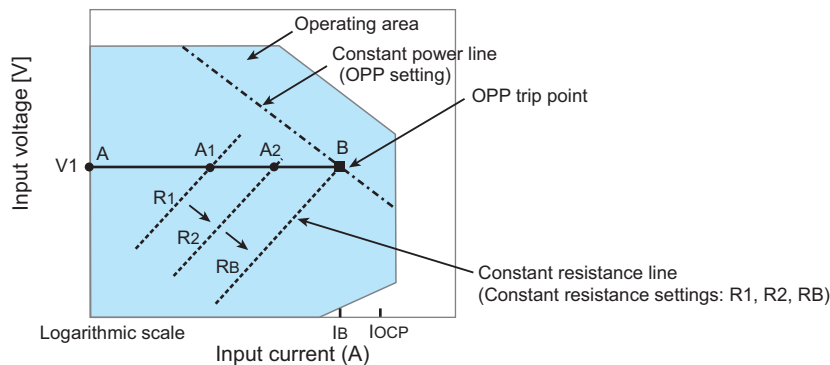

If the overcurrent protection (OCP) setting $IOCP$ is greater than the current value I_B at point B, when the PLZ-5W resistance is decreased ($R_1 \rightarrow R_2 \rightarrow R_B$) and the input current (load current) is increased with the voltage of the constant-voltage power supply at V_1 , the operating point moves along segment AB ($A_1 \rightarrow A_2 \rightarrow B$). When point B is reached, OPP is activated. At this point, two types of operation are available on the PLZ-5W depending on which action is set to be executed at OPP detection.

| Setting | Behavior |
|---------|-------------------------------------------------------------------------------------------------------------------------------------------------------------------------------------------------------------------------------------------------------------------------------------------------------------------------------------------------|
| Trip | Turns off the load (stops the current flow). |
| Limit | PLZ-5W sinks current as a constant power load at point B. Even if you attempt to increase the input current by decreasing the resistance, the current is limited at point B. If you decrease the input current by increasing the resistance, the OPP is cleared. The PLZ-5W returns to CR mode, and the operating point moves along segment AB. |

Transition of the operating point: Overcurrent protection (OCP) operation

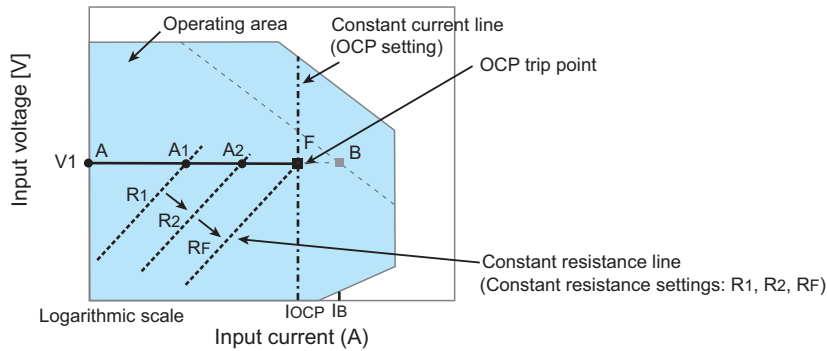

If the OCP setting I_{OCP} is smaller than the current value I_B at point B, when the PLZ-5W resistance is decreased ($R_1 \rightarrow R_2 \rightarrow R_F$) and the input current (load current) is increased with the voltage of the constant-voltage power supply at V_1 , the operating point moves along segment AF ($A_1 \rightarrow A_2 \rightarrow F$). When point F is reached, OCP is activated. At this point, two types of operation are available on the PLZ-5W depending on which action is set to be executed at OCP detection.

| Setting | Behavior |
|---------|---------------------------------------------------------------------------------------------------------------------------------------------------------------------------------------------------------------------------------------------------------------------------------------------------------------------------------------------------|
| Trip | Turns off the load (stops the current flow). |
| Limit | PLZ-5W sinks current as a constant current load at point F. Even if you attempt to increase the input current by decreasing the resistance, the current is limited at point F. If you decrease the input current by increasing the resistance, the OCP is cleared. The PLZ-5W returns to CR mode, and the operating point moves along segment AF. |

Constant power (CP) mode operation

Constant power mode operation

When the PLZ-5W is used in CP mode, the PLZ-5W operates as a constant power load as shown in the following figure. When voltage V_1 of the constant-voltage power supply increases, input current I decreases so that the power consumed by the PLZ-5W, $P=V \times I$, is kept constant. In the following figure, $P = V_1 \times I_1 = V_2 \times I_2$.

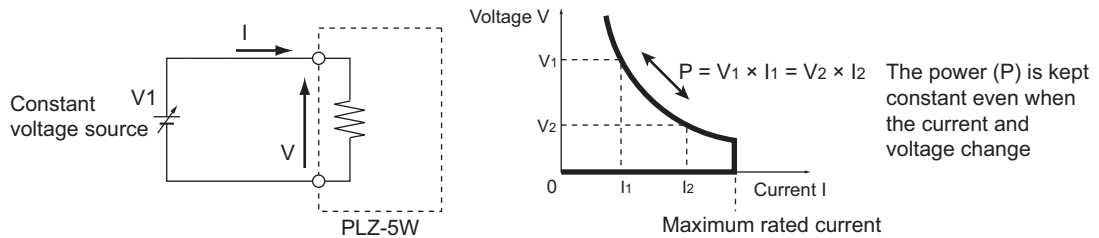

Transition of the operating point: Overcurrent protection (OCP) operation

Example: Examining the load characteristics of the constant-voltage power supply in CP mode.

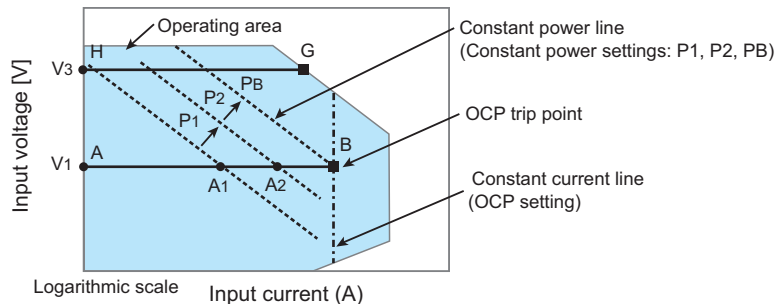

■ Operation on segment AB

If the voltage of the constant-voltage power supply is set to V_1 and the power of the PLZ-5W is increased ($P_1 \rightarrow P_2 \rightarrow P_B$) and the input current (load current) is increased, the operating point moves along segment AB ($A_1 \rightarrow A_2 \rightarrow B$). When point B is reached, OCP is activated. At this point, two types of operation are available on the PLZ-5W depending on which action is set to be executed at OCP detection.

| Setting | Behavior |
|---------|----------------------------------------------------------------------------------------------------------------------------------------------------------------------------------------------------------------------------------------------------------------------------------------|
| Trip | Turns off the load (stops the current flow). |
| Limit | PLZ-5W sinks current as a constant current load at point B. Even if you attempt to increase the input current, the current is limited at point B. If you decrease the input current, the OCP is cleared. The PLZ-5W returns to CP mode and the operating point moves along segment AB. |

■ Operation on segment GH

If the voltage of the constant-voltage power supply is set to V_3 and the power of the PLZ-5W is increased ($P_1 \rightarrow P_2 \rightarrow P_B$) and the input current (load current) is increased, the operating point moves along segment GH. Point G is the maximum power at the range being used.

Constant voltage (CV) mode operation

In CV mode, the PLZ-5W sinks current so that the voltage at the load input end of the PLZ-5W is constant.

Constant voltage mode operation

When the PLZ-5W is used in CV mode, the PLZ-5W operates as a constant voltage load (shunt regulator) as shown in the following figure. When V_1 is greater than V , input voltage V is kept constant even when input current I varies. Current does not flow when V_1 is less than or equal to V . The PLZ-5W may operate unstably if R_1 is low.

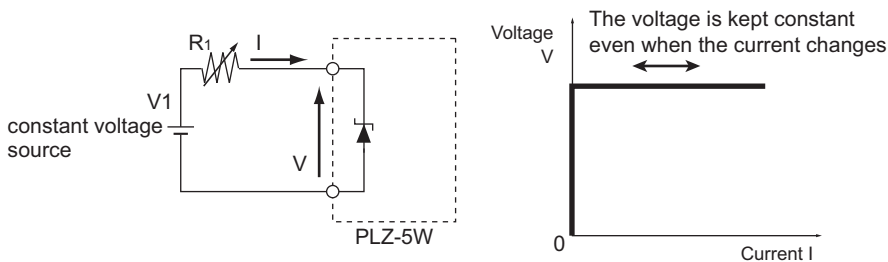

Transition of the operating point: Overpower protection (OPP) operation

Example: Examining in CV mode the load characteristics of the power supply with a large internal resistance

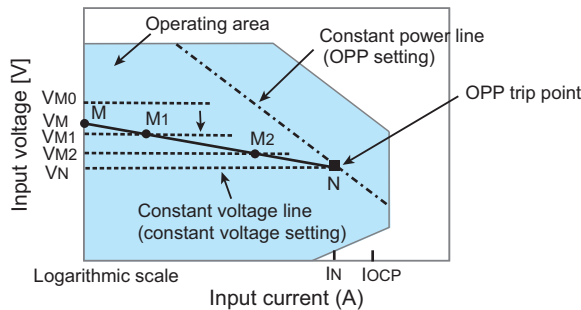

We assume that the overcurrent protection setting $IOCP$ is greater than current IN at point N and denote the voltage of the constant voltage power supply as VM . When voltage VM_0 of the PLZ-5W is greater than VM , no current flows. When the voltage of the PLZ-5W is decreased to a point where VM_0 is smaller than VM , the current starts flowing. If the voltage is decreased further ($VM_1 \rightarrow VM_2 \rightarrow VN$) to increase the input current (load current), the operating point moves along segment MN ($M_1 \rightarrow M_2 \rightarrow N$). When point N is reached, OPP is activated. At this point, two types of operation are available on the PLZ-5W depending on which action is set to be executed at OPP detection.

| Setting | Behavior |
|---------|-----------------------------------------------------------------------------------------------------------------------------------------------------------------------------------------------------------------------------------------------------------------------------------|
| Trip | Turns off the load (stops the current flow). |
| Limit | PLZ-5W sinks current as a constant power load at point N . Even if you attempt to decrease the voltage, the current is limited at point N . If you increase the voltage, the OPP is cleared. The PLZ-5W returns to CV mode and the operating point moves along segment MN . |

Transition of the operating point: Overcurrent protection (OCP) operation

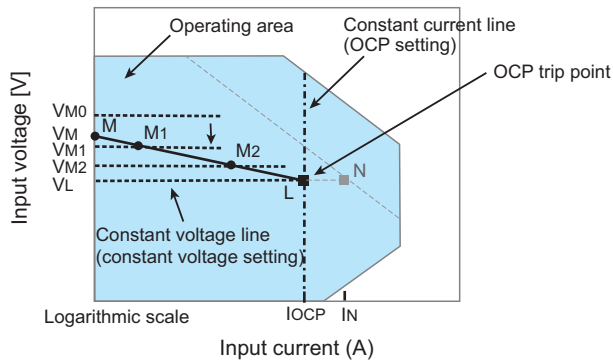

We assume that OCP setting I_{OCP} is smaller than current I_N at point N and denote the voltage of the constant voltage power supply as V_M . When voltage V_{M0} of the PLZ-5W is greater than V_M , no current flows. When the voltage of the PLZ-5W is decreased to a point where V_{M0} is smaller than V_M , the current starts flowing. If the voltage is decreased further ($V_{M1} \rightarrow V_{M2} \rightarrow V_L$) to increase the input current (load current), the operating point moves along segment ML ($M1 \rightarrow M2 \rightarrow L$). When point L is reached, OCP is activated. At this point, two types of operation are available on the PLZ-5W depending on which action is set to be executed at OCP detection.

| Setting | Behavior |
|---------|------------------------------------------------------------------------------------------------------------------------------------------------------------------------------------------------------------------------------------------------------------------------------------|
| Trip | Turns off the load (stops the current flow). |
| Limit | PLZ-5W sinks current as a constant current load at point L. Even if you attempt to decrease the voltage current, the current is limited at point L. If you increase the voltage, the OCP is cleared. The PLZ-5W returns to CV mode and the operating point moves along segment ML. |

Operation when CV mode is added to CC mode

Constant current+constant voltage mode operation

When CV mode is added to CC mode, the PLZ-5W operates as a constant current and load constant voltage load (shunt regulator), as shown in the following figure. When operating as a constant current load, the PLZ-5W sinks specified current I even when output voltage V_M of the constant-voltage power supply changes. When operating as a constant voltage load and V_M is greater than V , input voltage V is kept constant even when input current I varies. Current does not flow when V_M is less than or equal to V .

Both modes are automatically switched to. In CV mode, the PLZ-5W may operate unstably if R_1 is low.

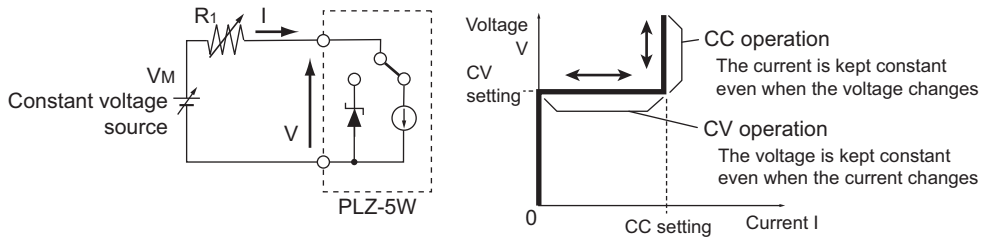

Transition of the operating point: Overpower protection (OPP) operation

Example: Examining the discharge characteristics of a battery

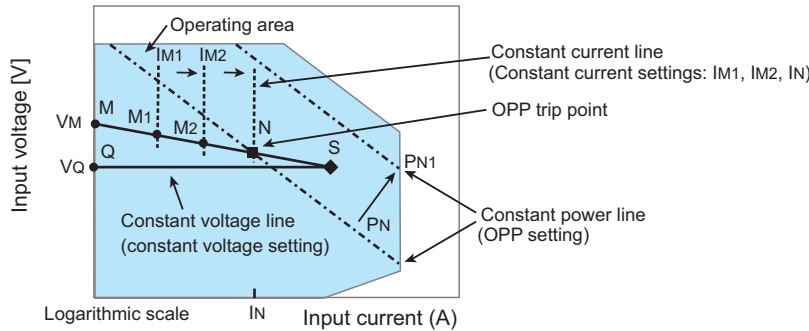

We denote the voltage of the battery as V_M . In CC mode, if the current is increased ($I_{M1} \rightarrow I_{M2} \rightarrow I_N$) to increase the input current (load current), the operating point moves along segment MN ($M1 \rightarrow M2 \rightarrow N$). If the OPP setting is P_N , the OPP is activated when point N is reached. At this point, two types of operation are available on the PLZ-5W depending on which action is set to be executed at OPP detection.

| Setting | Behavior |
|---------|--------------------------------------------------------------------------------------------------------------------------------------------------------------------------------------------------------------------------------------------------------------------------------|
| Trip | Turns off the load (stops the current flow). |
| Limit | PLZ-5W sinks current as a constant power load at point N. Even if you attempt to increase the input current, the current is limited at point N. If you decrease the current, the OPP is cleared. The PLZ-5W returns to CC mode and the operating point moves along segment MN. |

If the OPP setting is P_{N1} , the OPP is not activated as the current is increased, and the operating point reaches point S. Here, the operation mode is CV. The voltage is fixed to voltage V_Q set in advance. In this case, the operating point moves along segment QS. The current is determined by the battery voltage and its internal resistance.

Operation when CV mode is added to CR mode

Constant resistance + constant voltage mode operation

When CV mode is added to CR mode, the PLZ-5W operates as a constant resistance load and constant voltage load (shunt regulator), as shown in the following figure. When the PLZ-5W operates as a constant resistance load and voltage V_M of the constant-voltage power supply is varied, the PLZ-5W sinks current to meet $I=V/R$ according to the specified resistance R . When operating as a constant voltage load and V_M is greater than V , input voltage V is kept constant even when input current I varies. Current does not flow when V_M is less than or equal to V .

Both modes are automatically switched to. In CV mode, the PLZ-5W may operate unstably if R_1 is low.

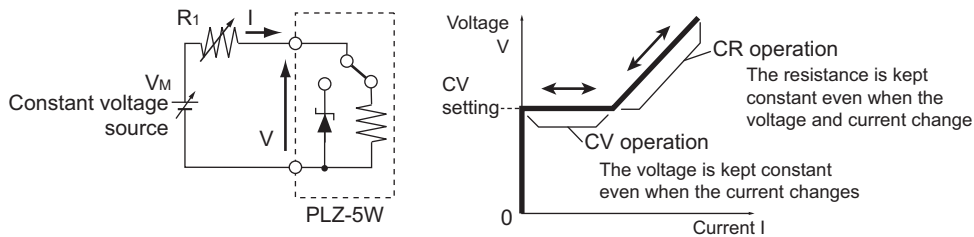

Transition of the operating point: Overpower protection (OPP) operation

Example: Examining the discharge characteristics of a battery

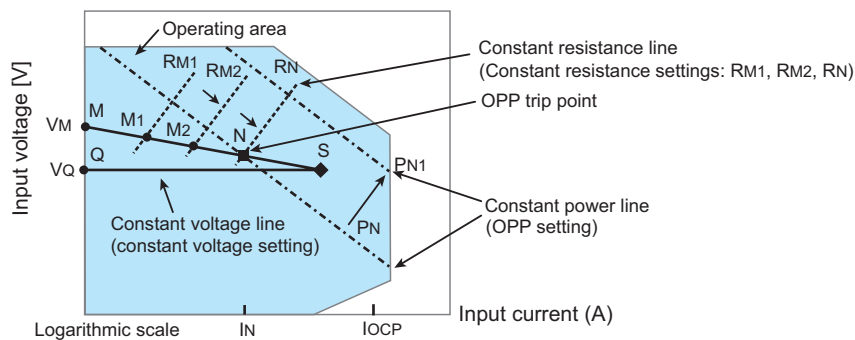

We assume that OCP setting I_{OCP} is greater than current I_N at point N and denote the voltage of the battery as V_M . In CR mode, if the resistance is decreased ($R_{M1} \rightarrow R_{M2} \rightarrow R_N$) to increase the input current (load current), the operating point moves along segment MN ($M_1 \rightarrow M_2 \rightarrow N$). If the OPP setting is PN, the OPP is activated when point N is reached. At this point, two types of operation are available on the PLZ-5W depending on which action is set to be executed at OPP detection.

| Setting | Behavior |
|---------|------------------------------------------------------------------------------------------------------------------------------------------------------------------------------------------------------------------------------------------------------------------------------------------------------------------------------------|
| Trip | Turns off the load (stops the current flow). |
| Limit | PLZ-5W sinks current as a constant power load at point N. Even if you attempt to increase the current by decreasing the resistance, the current is limited at point N. If you decrease the current by increasing the resistance, the OPP is cleared. The PLZ-5W returns to CR mode and the operating point moves along segment MN. |

If the OPP setting is PN_1 , the OPP is not activated as the current is increased by decreasing the resistance, and the operating point reaches point S. Here, the operation mode is CV. The voltage is fixed to voltage V_Q set in advance. In this case, the operating point moves along segment QS. The current is determined by the battery voltage and its internal resistance.

Transition of the operating point: Overcurrent protection (OCP) operation

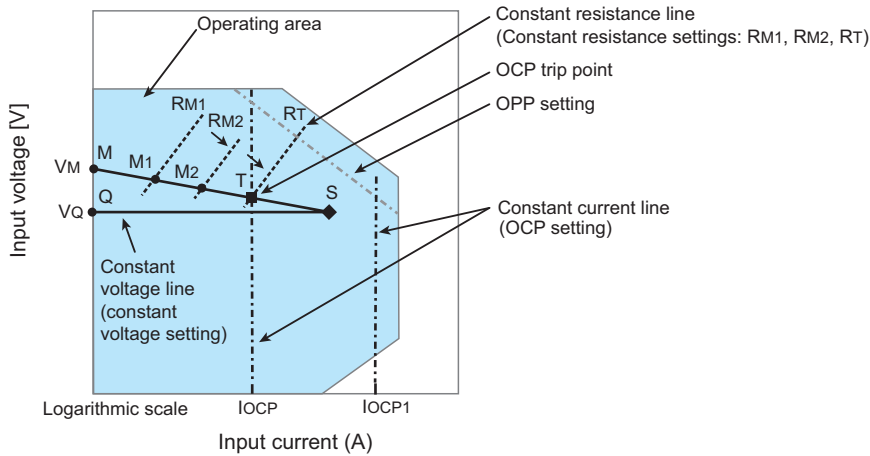

We assume that OCP setting I_{OCP} is less than the current produced by tripping of the overpower protection (OPP) and denote the voltage of the battery as V_M . In CR mode, if the resistance is decreased ($R_{M1} \rightarrow R_{M2} \rightarrow R_T$) to increase the input current (load current), the operating point moves along segment MT ($M1 \rightarrow M2 \rightarrow T$). If the OCP setting is I_{OCP} , the OCP is activated when point T is reached. At this point, two types of operation are available on the PLZ-5W depending on which action is set to be executed at OCP detection.

| Setting | Behavior |
|---------|--------------------------------------------------------------------------------------------------------------------------------------------------------------------------------------------------------------------------------------------------------------------------------------------------------------------------------------|
| Trip | Turns off the load (stops the current flow). |
| Limit | PLZ-5W sinks current as a constant current load at point T. Even if you attempt to increase the current by decreasing the resistance, the current is limited at point T. If you decrease the current by increasing the resistance, the OCP is cleared. The PLZ-5W returns to CR mode and the operating point moves along segment MT. |

If the OCP setting is I_{OCP1} , the OCP is not activated as the current is increased by decreasing the resistance, and the operating point reaches point S. Here, the operation mode is CV. The voltage is fixed to voltage V_Q set in advance. In this case, the operating point moves along segment QS. The current is determined by the battery voltage and its internal resistance.

Operating area of each model

Operating area of the PLZ205W

■ H range

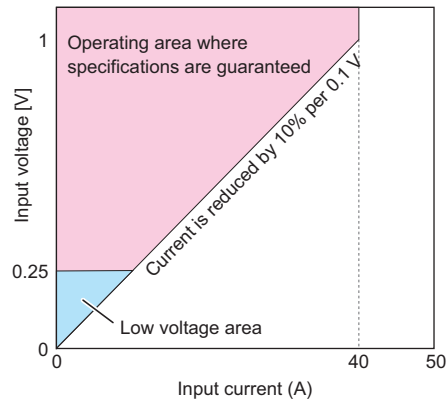
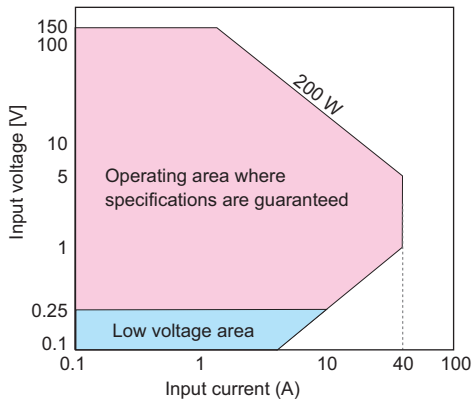

■ M range

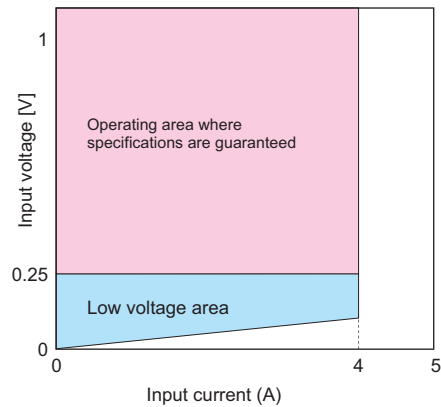
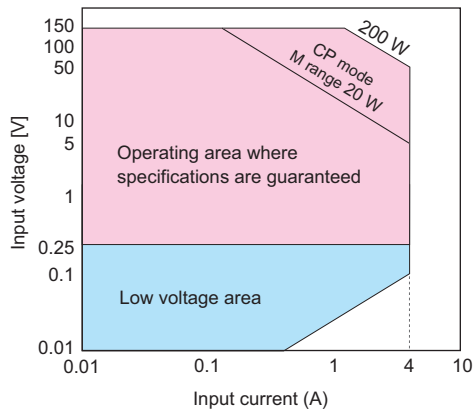

■ L range

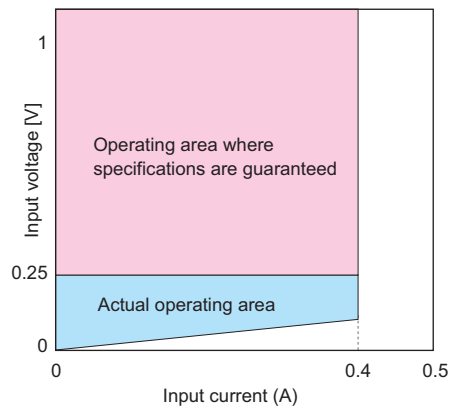
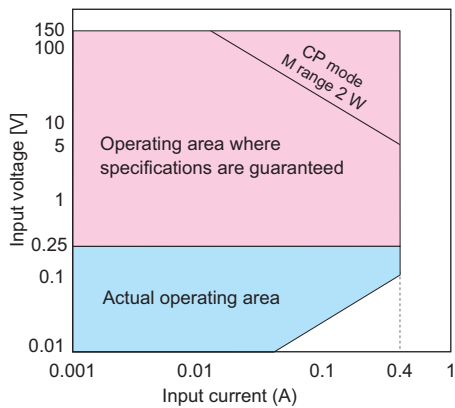

Operating area of the PLZ405W

■ H range

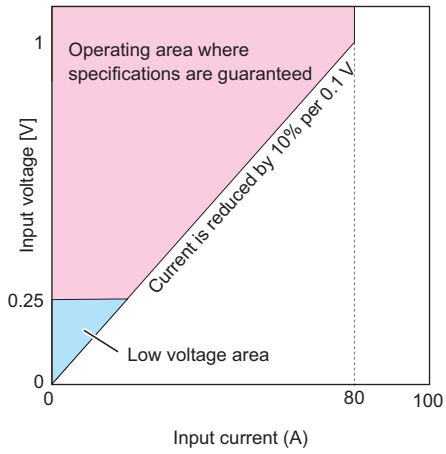
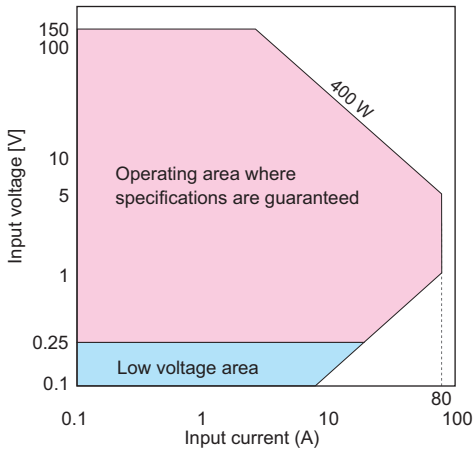

■ M range

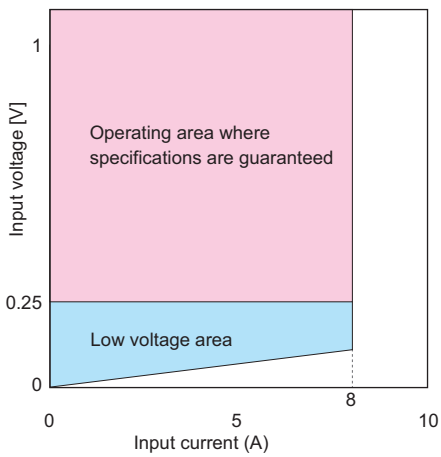
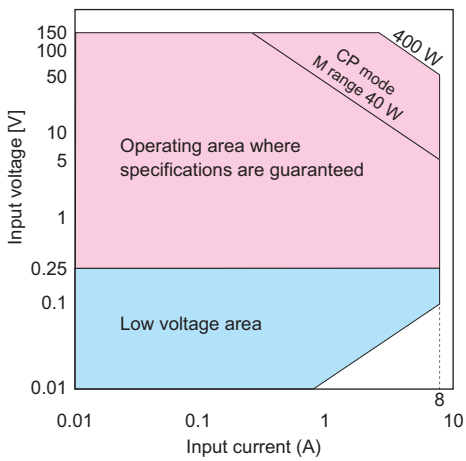

■ L range

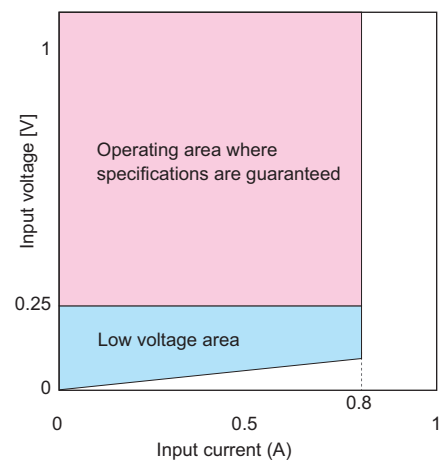
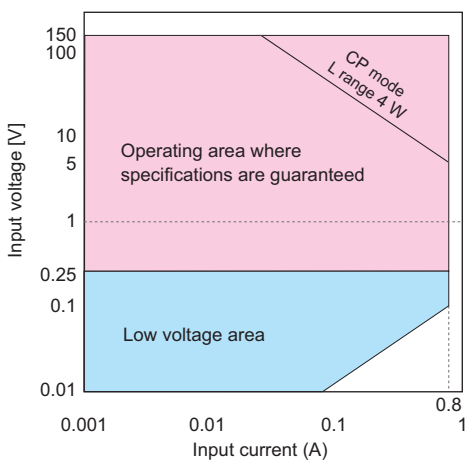

Operating area of the PLZ1205W

■ H range

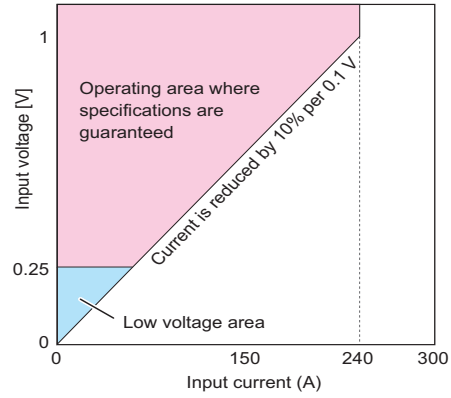
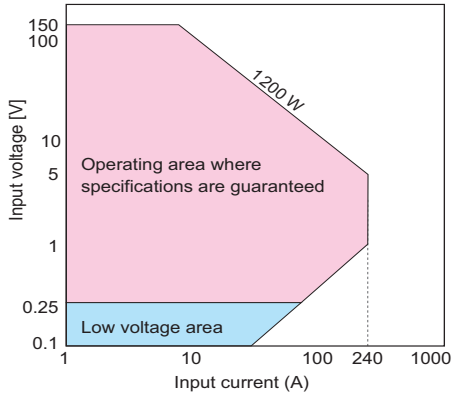

■ M range

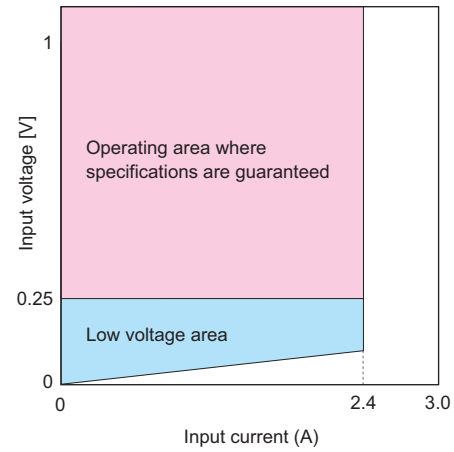
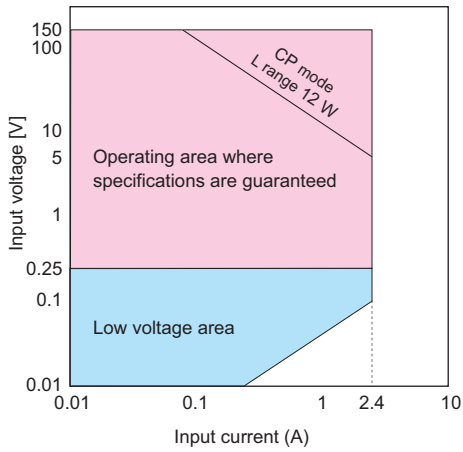

■ L range

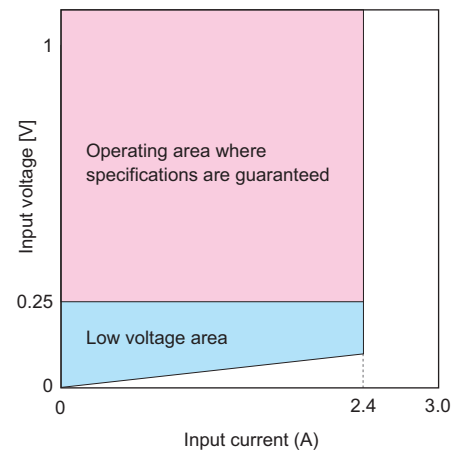
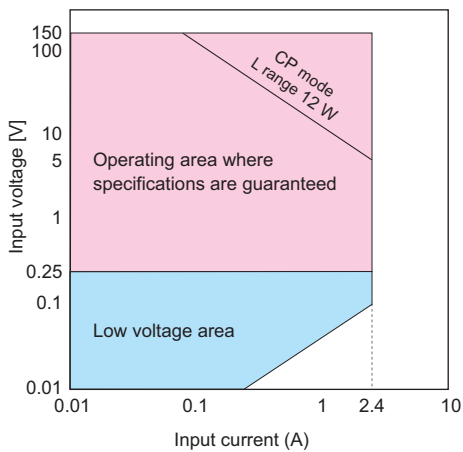

Response Time and Waveform When an OPP Is Activated

This section indicates the response time and waveform when an overpower protection (OPP) is activated when the action to perform is set to Limit.

Response time

The OPP response time varies depending on the amplitude of the load power and the amplitude of the load current exceeding the OPP setting. The relationship between the time until an OPP is activated and the load power in CC mode is indicated below.

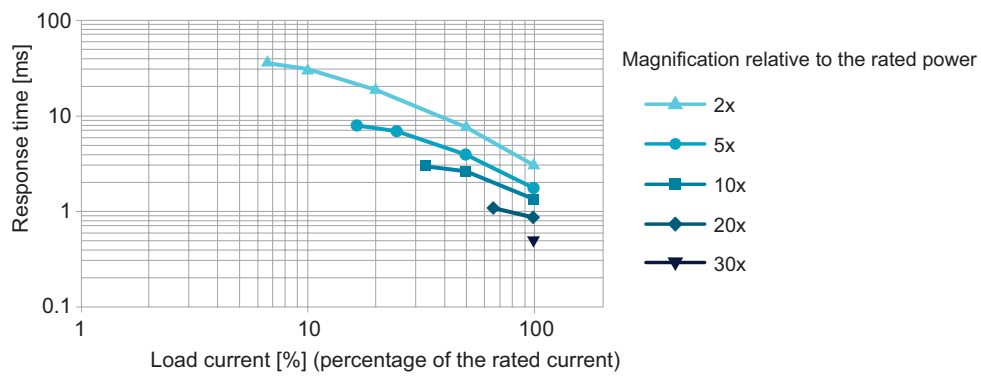

waveform

■ When the load power is twice the rated power (when set to rated current)

When the load current changes

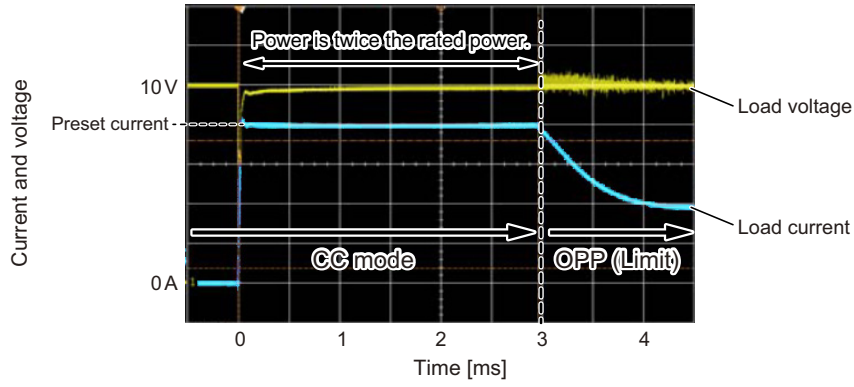

When the load voltage changes

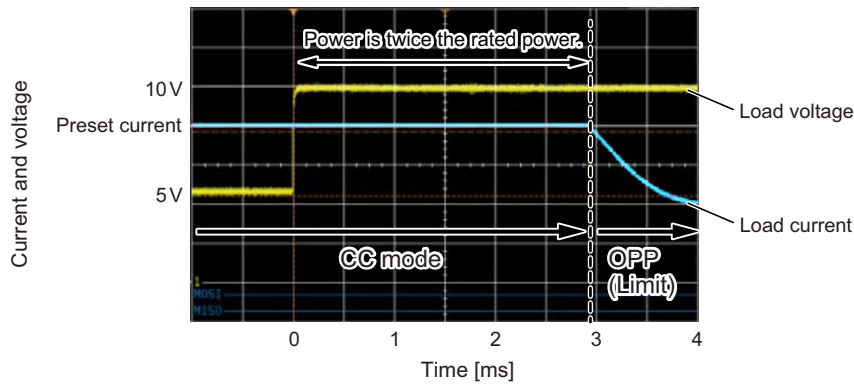

■ When the load power is 30 times the rated power (when set to rated current)

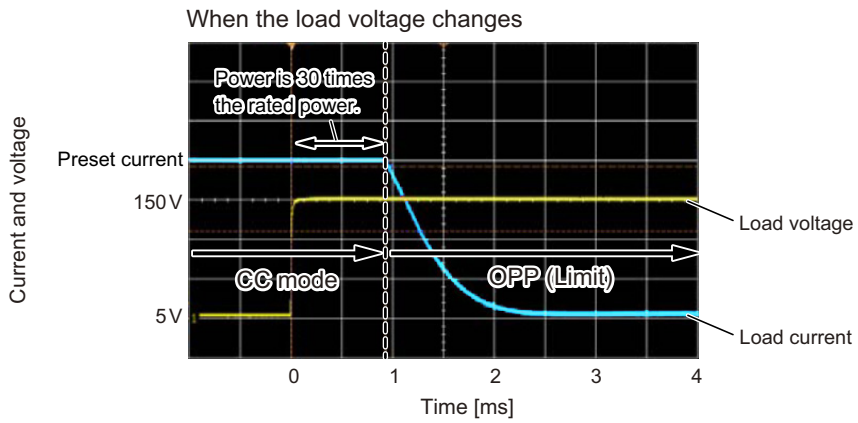
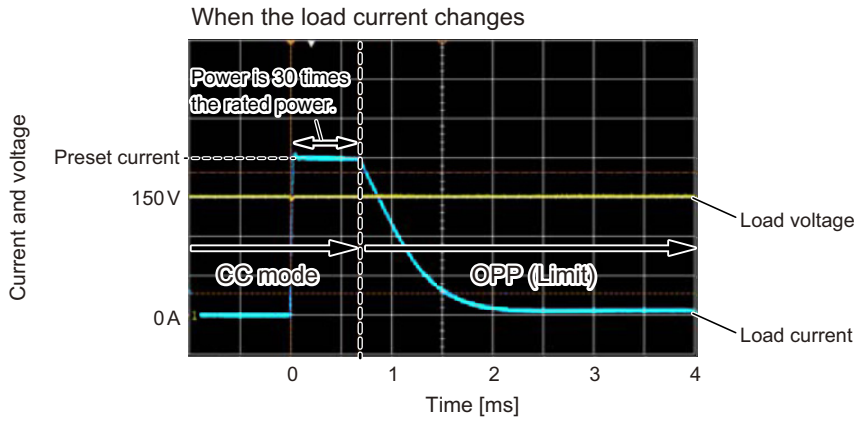

Operating Range during Parallel Operation

The operating range during parallel operation using the same model or load boosters is shown for each operation mode.

Parallel operation using the same type of electronic loads

CC mode

■ Operating range

| Model name | Number of slaves | H range | M range | L range |
|------------|------------------|---------------|--------------|--------------|
| PLZ205W | 1 | 0 A to 80 A | 0 A to 8 A | 0 A to 0.8 A |
| | 2 | 0 A to 120 A | 0 A to 12 A | 0 A to 1.2 A |
| | 3 | 0 A to 160 A | 0 A to 16 A | 0 A to 1.6 A |
| | 4 | 0 A to 200 A | 0 A to 20 A | 0 A to 2 A |
| PLZ405W | 1 | 0 A to 160 A | 0 A to 16 A | 0 A to 1.6 A |
| | 2 | 0 A to 240 A | 0 A to 24 A | 0 A to 2.4 A |
| | 3 | 0 A to 320 A | 0 A to 32 A | 0 A to 3.2 A |
| | 4 | 0 A to 400 A | 0 A to 40 A | 0 A to 4 A |
| PLZ1205W | 1 | 0 A to 480 A | 0 A to 48 A | 0 A to 4.8 A |
| | 2 | 0 A to 720 A | 0 A to 72 A | 0 A to 7.2 A |
| | 3 | 0 A to 960 A | 0 A to 96 A | 0 A to 9.6 A |
| | 4 | 0 A to 1200 A | 0 A to 120 A | 0 A to 12 A |

■ Slew rate

| Model name | Number of slaves | H range | M range | L range |
|------------|------------------|-----------------------------------|-----------------------------------|-------------------------------------|
| PLZ205W | 1 | 0.02 A/ μ s to 20 A/ μ s | 0.002 A/ μ s to 2 A/ μ s | 0.2 mA/ μ s to 200 mA/ μ s |
| | 2 | 0.03 A/ μ s to 30 A/ μ s | 0.003 A/ μ s to 3 A/ μ s | 0.3 mA/ μ s to 300 mA/ μ s |
| | 3 | 0.04 A/ μ s to 40 A/ μ s | 0.004 A/ μ s to 4 A/ μ s | 0.4 mA/ μ s to 400 mA/ μ s |
| | 4 | 0.05 A/ μ s to 50 A/ μ s | 0.005 A/ μ s to 5 A/ μ s | 0.5 mA/ μ s to 500 mA/ μ s |
| PLZ405W | 1 | 0.04 A/ μ s to 40 A/ μ s | 0.004 A/ μ s to 4 A/ μ s | 0.4 mA/ μ s to 400 mA/ μ s |
| | 2 | 0.06 A/ μ s to 60 A/ μ s | 0.006 A/ μ s to 6 A/ μ s | 0.6 mA/ μ s to 600 mA/ μ s |
| | 3 | 0.08 A/ μ s to 80 A/ μ s | 0.008 A/ μ s to 8 A/ μ s | 0.8 mA/ μ s to 800 mA/ μ s |
| | 4 | 0.10 A/ μ s to 100 A/ μ s | 0.010 A/ μ s to 10 A/ μ s | 1.0 mA/ μ s to 1000 mA/ μ s |
| PLZ1205W | 1 | 0.12 A/ μ s to 120 A/ μ s | 0.012 A/ μ s to 12 A/ μ s | 1.2 mA/ μ s to 1200 mA/ μ s |
| | 2 | 0.18 A/ μ s to 180 A/ μ s | 0.018 A/ μ s to 18 A/ μ s | 1.8 mA/ μ s to 1800 mA/ μ s |
| | 3 | 0.24 A/ μ s to 240 A/ μ s | 0.024 A/ μ s to 24 A/ μ s | 2.4 mA/ μ s to 2400 mA/ μ s |
| | 4 | 0.30 A/ μ s to 300 A/ μ s | 0.030 A/ μ s to 30 A/ μ s | 3.0 mA/ μ s to 3000 mA/ μ s |

CR mode

■ Operating range

| Model name | Number of slaves | H range | M range | L range |
|------------|------------------|------------------|------------------|------------------|
| PLZ205W | 1 | 80 S to 0.004 S | 8 S to 0.0004 S | 0.8 S to 0.04 mS |
| | 2 | 120 S to 0.006 S | 12 S to 0.0006 S | 1.2 S to 0.06 mS |
| | 3 | 160 S to 0.008 S | 16 S to 0.0008 S | 1.6 S to 0.08 mS |
| | 4 | 200 S to 0.01 S | 20 S to 0.001 S | 2 S to 0.1 mS |
| PLZ405W | 1 | 160 S to 0.008 S | 16 S to 0.0008 S | 1.6 S to 0.08 mS |
| | 2 | 240 S to 0.012 S | 24 S to 0.0012 S | 2.4 S to 0.12 mS |
| | 3 | 320 S to 0.016 S | 32 S to 0.0016 S | 3.2 S to 0.16 mS |
| | 4 | 400 S to 0.02 S | 40 S to 0.002 S | 4 S to 0.2 mS |
| PLZ1205W | 1 | 480 S to 0.024 S | 48 S to 0.0024 S | 4.8 S to 0.24 mS |
| | 2 | 720 S to 0.036 S | 72 S to 0.0036 S | 7.2 S to 0.36 mS |
| | 3 | 960 S to 0.048 S | 96 S to 0.0048 S | 9.6 S to 0.48 mS |
| | 4 | 1200 S to 0.06 S | 120 S to 0.006 S | 12 S to 0.6 mS |

CV mode

■ Operating range

| Model name | Number of slaves | H range | L range |
|--------------------------|------------------|-----------------|----------------|
| PLZ205W/PLZ405W/PLZ1205W | 1 to 4 | 0.25 V to 150 V | 0.25 V to 15 V |

CP mode

■ Operating range

| Model name | Number of slaves | H range | M range | L range |
|------------|------------------|-----------------|---------------|---------------|
| PLZ205W | 1 | 40 W to 400 W | 4 W to 40 W | 0.4 W to 4 W |
| | 2 | 60 W to 600 W | 6 W to 60 W | 0.6 W to 6 W |
| | 3 | 80 W to 800 W | 8 W to 80 W | 0.8 W to 8 W |
| | 4 | 100 W to 1000 W | 10 W to 100 W | 1 W to 10 W |
| PLZ405W | 1 | 80 W to 800 W | 8 W to 80 W | 0.8 W to 8 W |
| | 2 | 120 W to 1200 W | 12 W to 120 W | 1.2 W to 12 W |
| | 3 | 160 W to 1600 W | 16 W to 160 W | 1.6 W to 16 W |
| | 4 | 200 W to 2000 W | 20 W to 200 W | 2 W to 20 W |
| PLZ1205W | 1 | 240 W to 2400 W | 24 W to 240 W | 2.4 W to 24 W |
| | 2 | 360 W to 3600 W | 36 W to 360 W | 3.6 W to 36 W |
| | 3 | 480 W to 4800 W | 48 W to 480 W | 4.8 W to 48 W |
| | 4 | 600 W to 6000 W | 60 W to 600 W | 6 W to 60 W |

Parallel operation using boosters

CC mode

■ Operating range

| Model name | Number of boosters | H range | M range | L range |
|----------------------|--------------------|---------------|--------------|---------------|
| PLZ1205W + PLZ2405WB | 1 | 0 A to 720 A | 0 A to 72 A | 0 A to 7.2 A |
| | 2 | 0 A to 1200 A | 0 A to 120 A | 0 A to 12 A |
| | 3 | 0 A to 1680 A | 0 A to 168 A | 0 A to 16.8 A |
| | 4 | 0 A to 2160 A | 0 A to 216 A | 0 A to 21.6 A |

■ Slew rate

| Model name | Number of boosters | H range | M range | L range |
|----------------------|--------------------|-----------------------------------|-----------------------------------|-------------------------------------|
| PLZ1205W + PLZ2405WB | 1 | 0.18 A/ μ s to 180 A/ μ s | 0.018 A/ μ s to 18 A/ μ s | 1.8 mA/ μ s to 1800 mA/ μ s |
| | 2 | 0.30 A/ μ s to 300 A/ μ s | 0.030 A/ μ s to 30 A/ μ s | 3.0 mA/ μ s to 3000 mA/ μ s |
| | 3 | 0.42 A/ μ s to 420 A/ μ s | 0.042 A/ μ s to 42 A/ μ s | 4.2 mA/ μ s to 4200 mA/ μ s |
| | 4 | 0.54 A/ μ s to 540 A/ μ s | 0.054 A/ μ s to 54 A/ μ s | 5.4 mA/ μ s to 5400 mA/ μ s |

CR mode

■ Operating range

| Model name | Number of boosters | H range | M range | L range |
|----------------------|--------------------|-------------------|-------------------|-------------------|
| PLZ1205W + PLZ2405WB | 1 | 720 S to 0.036 S | 72 S to 0.0036 S | 7.2 S to 0.36 mS |
| | 2 | 1200 S to 0.06 S | 120 S to 0.006 S | 12 S to 0.6 mS |
| | 3 | 1680 S to 0.084 S | 168 S to 0.0084 S | 16.8 S to 0.84 mS |
| | 4 | 2160 S to 0.108 S | 216 S to 0.0108 S | 21.6 S to 1.08 mS |

CV mode

■ Operating range

| Model name | Number of boosters | H range | L range |
|----------------------|--------------------|-----------------|----------------|
| PLZ1205W + PLZ2405WB | 1 to 4 | 0.25 V to 150 V | 0.25 V to 15 V |

CP mode

■ Operating range

| Model name | Number of boosters | H range | M range | L range |
|-------------------------|--------------------|-------------------|-----------------|-----------------|
| PLZ1205W + PLZ2405WB | 1 | 360 W to 3600 W | 36 W to 360 W | 3.6 W to 36 W |
| | 2 | 600 W to 6000 W | 60 W to 600 W | 6 W to 60 W |
| | 3 | 840 W to 8400 W | 84 W to 840 W | 8.4 W to 84 W |
| | 4 | 1080 W to 10800 W | 108 W to 1080 W | 10.8 W to 108 W |

Options

This product has the following options.
For information about options, contact your Kikusui agent or distributor.

Rack adapters, brackets

These are rack mounting options. Be sure to use support angles (auxiliary brackets) to safely support the product.

| Name | Model | Appropriate Model | Description |
|------------------|------------|-------------------|--------------------------|
| Rack adapters *1 | KRA3 | PLZ205W | For EIA inch racks |
| | KRA150 | PLZ405W | For JIS millimeter racks |
| Bracket | KRB3-TOS | PLZ1205W | For EIA inch racks |
| | KRB150-TOS | | For JIS millimeter racks |

*1. When using blank panels for rack adapters, please use KBP3-2.

To rack mount the PLZ-5W, remove the handle of the PLZ-5W and the rubber feet.

Removing the handle and the rubber feet

NOTE

- We recommend that you keep all the pieces that you remove from the PLZ-5W. You will need these pieces if you remove the PLZ-5W from the rack. Particularly when reattaching the rubber legs, please use the rivets and screw pins that were removed.
- To reinstall the handle that has been removed, use screw locking agent (e.g., 1401B by ThreeBond International, Inc.) to prevent screws from loosening.

■ PLZ205W/PLZ405W

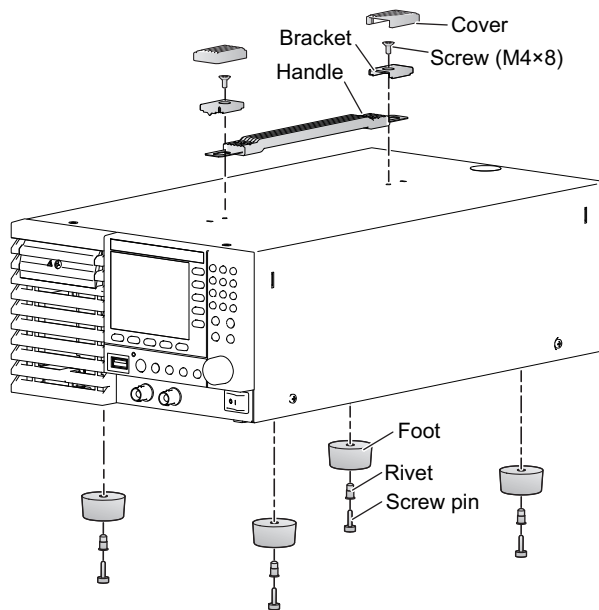

- 1** Remove the two handle covers.
- 2** Unfasten the two screws, and remove the entire handle.
- 3** While pulling down the rubber feet (four locations), loosen their screw pin with a screwdriver and remove the feet.

This completes the removal.

■ PLZ1205W

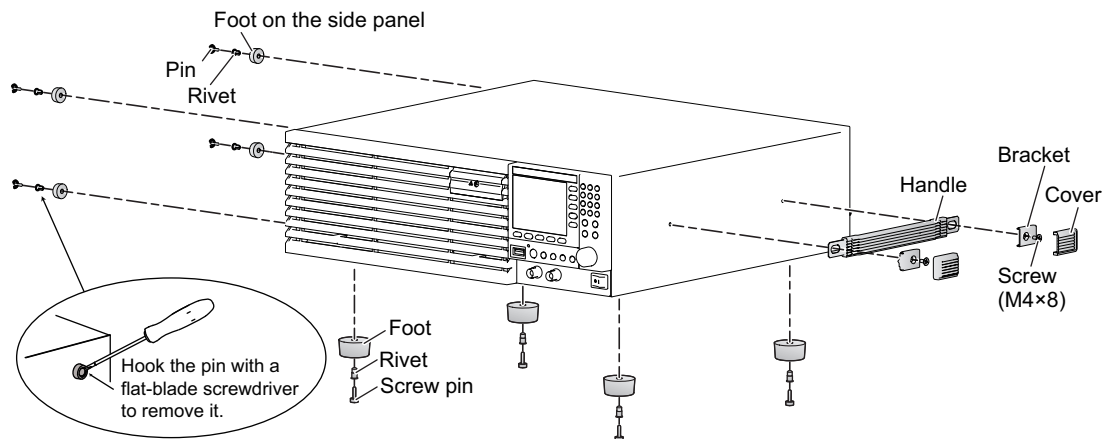

- 1** Remove the two handle covers.
- 2** Unfasten the two screws, and remove the entire handle.
- 3** While pulling down the rubber feet (four locations) of the bottom panel, loosen their screw pin with a screwdriver and remove the feet.
- 4** Unfasten the internal pins from the rubber feet (four locations) of the side panel using a flat-blade screwdriver, and then remove the feet.

This completes the removal.

Attaching the rack adapter or bracket.

NOTE

When mounting the PLZ-5W on a rack, be sure to use support angles (auxiliary brackets) to safely support the product.

For information on rack mounting, see the manual of the relevant frame and bracket.

■ **PLZ205W/ PLZ405W**

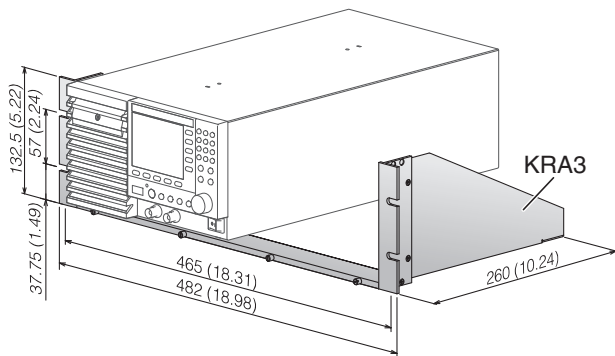

Rack adapter

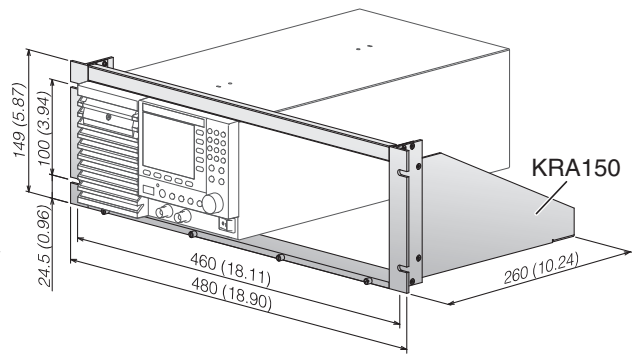

Unit: mm (inches)

■ **PLZ1205W**

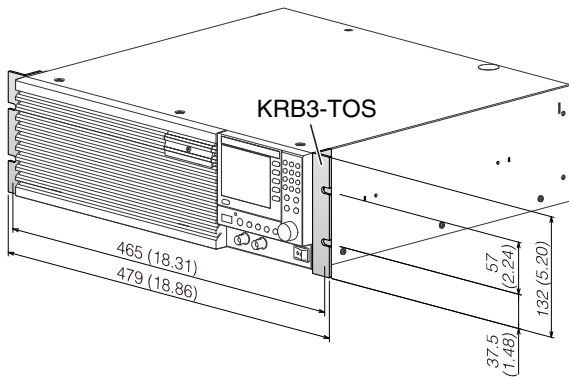

Bracket

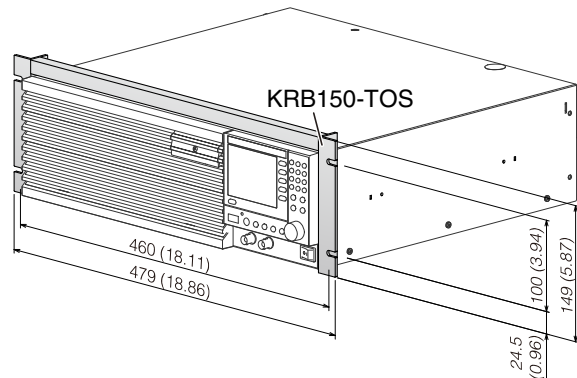

Unit: mm (inches)

GPIB converter (PIA5100)

This converter converts RS232C or USB of the PLZ-5W to GPIB, enabling connection of a remote controller using GPIB. Perform the connection as shown below.

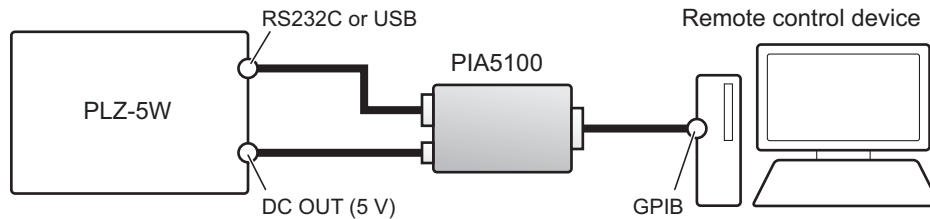

The GPIB communication specifications are as follows.

| Item | Specifications |
|--------------------|-----------------------------------------------------------------------------------|
| Hardware | Complies with IEEE Std 488.1-1987 SH1, AH1, T6, L4, SR1, PP0, DC1, DT1, C0, E1 |
| Message terminator | LF or EOI during reception, LF + EOI during transmission |
| Primary address | 0 to 30 |

When you connect a PIA5100, you cannot use the PLZ-5W's RS232C or USB port.

Some restrictions apply to the GPIB functions that can be used with the PIA5100. When connected through RS232C, the PLZ-5W supports the KISTD SAFU protocol.

For details, see the GPIB converter (PIA5100) operation manual.

Parallel operation signal cable kit (PC01-PLZ-5W)

This kit contains a signal cable for performing parallel operation on the PLZ-5W.

Cable length: Approx 30 cm

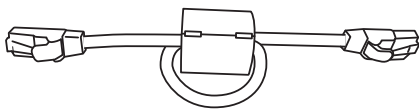

Low inductance cable

This is a load cable with suppressed inductance. It suppresses voltage drops that occur when current fluctuations are fast. For details, see the Low Inductance Cable Manual on the included CD-ROM.

Large current load cable

This load cable supports large current. It supports currents up to 1000 A. For details, see the Large Current Load Cable Manual in the included CD-ROM.

Troubleshooting

This section introduces troubleshooting measures. Typical symptoms are listed. Check whether any of the items listed below apply to your case. In some cases, the problem can be solved quite easily.

If none of the items apply to your case, we recommend that you initialize the PLZ-5W to its factory default settings ([p.121](#)). If following the remedy does not solve your problem, contact your Kikusui agent or distributor.

■ Nothing appears on the display when the POWER switch is turned on.

| Check item | Possible cause | Remedy |
|--------------------------------------------------------------------|-----------------------------------------------------------------------------------|------------------------------------------------------------------------------------------------------|
| Is the rated voltage being applied to the input power supply (AC)? | Broken power cord. Bad connection at the AC INPUT connector on the rear panel. | Check that the power cord is not broken and that the connection at the AC INPUT connector is secure. |

■ Keys do not work.

| Check item | Possible cause | Remedy |
|------------------------------------------------------|--------------------------|-------------------------------------|
| Are the keys locked? (🔒/🔓/🔒 is shown on the display) | The key lock is enabled. | Hold down ENTER to unlock the keys. |

■ Input current is unstable or oscillates.

| Check item | Possible cause | Remedy |
|--------------------------------------------------------------------|-------------------------------------------------------|----------------------------------------------------------------------------------------------------------------------------|
| Is the rated voltage being applied to the input power supply (AC)? | Low supply voltage. | Use the PLZ-5W in the input supply voltage range. |
| Is an alarm occurring? | An internal or external error occurred on the PLZ-5W. | Check the type of alarm, and eliminate the root cause of the alarm (p.40). |
| Is there a large loop in the load cable? | The wire inductance has increased. | Twist the wires. See "Preventing large voltage variation when load current changes suddenly" (p.144). |
| Does the behavior change depending on the length of the wiring? | A proper response speed is not being used. | Change the response speed (p.54). |

■ An alarm is occurring.

| Check item | Possible cause | Remedy |
|--------------------------------------------------|----------------------------------|--------------------------------------------------------------------------------------------------------------------------------------------------------|
| Has overheat detection (OTP) been activated? | The fan has stopped. | Immediately stop using the PLZ-5W, and have it repaired. |
| | Vent or inlet holes are blocked. | Move the product so that there is at least 60 cm of space between the vents and the surrounding walls. Do not place objects within 60 cm of the vents. |
| Has overcurrent protection (OCP) been activated? | The OCP setting is small. | Set an appropriate OCP value on the setup screen (p.42). |
| Has overpower protection (OPP) been activated? | The OPP setting is small. | Set an appropriate OPP value on the setup screen (p.43). |

■ The load cannot be turned on.

| Check item | Possible cause | Remedy |
|---------------------------------------------------------|--------------------------------------------------------------------------------|-------------------------------------------------------------------------------------------------------------------|
| A sequence is in operation. | The load cannot be turned on manually when a sequence is in operation. | Wait for the sequence operation to finish. Abort the sequence by pressing the Abort key (p.89). |
| Is the load on/off logic (Input Logic) set to Negative? | The logic is incorrect. | Set Input Logic to Positive (p.98). |
| Are you using an external signal to turn the load off? | When the load is turned off through external control, the LOAD key is invalid. | The load key will be valid after you use an external signal to turn the load on (p.98). |

■ The load suddenly turns off.

| Check item | Possible cause | Remedy |
|----------------------------|-----------------------------|--------------------------------------------------------------|
| Is the load off timer set? | The load off timer expired. | Set the auto load off timer to OFF (p.58). |

■ External control (CC/CR/CP) cannot be set.

| Check item | Possible cause | Remedy |
|-------------------------------|------------------------------------------------------------|-----------------------------------------------------------|
| The switching function is on. | Cannot be used simultaneously with the switching function. | Turn off the switching function (p.39). |
| The short function is on. | Cannot be used simultaneously with the short function. | Turn off the short function (p.36). |

■ The switching function cannot be set.

| Check item | Possible cause | Remedy |
|------------------------------------|---------------------------------------------------------------------|--------------------------------------------------------------------|
| External control (CC/CR/CP) is on. | Cannot be used simultaneously with the external control (CC/CR/CP). | Turn off the external control (CC/CR/CP) (p.95). |
| The short function is on. | Cannot be used simultaneously with the short function. | Turn off the short function (p.36). |

■ Short function cannot be set.

| Check item | Possible cause | Remedy |
|------------------------------------|---------------------------------------------------------------------|--------------------------------------------------------------------|
| The switching function is on. | Cannot be used simultaneously with the switching function. | Turn off the switching function (p.39). |
| External control (CC/CR/CP) is on. | Cannot be used simultaneously with the external control (CC/CR/CP). | Turn off the external control (CC/CR/CP) (p.95). |

Index

A

ABC preset memories 60
accessories 3
alarm
 occurrence 45
 type 40
ARB mode 30
arbitrary I-V characteristics mode 30
auto load off timer 58

B

battery replacement 127
beep sound 115
BNC connector 137

C

calibration 127
CC mode 26, 28, 148, 154
CC+CV 28, 154
CLEAR key 22
clearing
 alarms 46
communication function 137
component names 8
conductance 26
constant current mode 26, 28, 148,
 154
constant power mode 27, 151
constant resistance mode ... 26, 29,
 149, 155
constant voltage mode . 27, 28, 29,
 152, 154, 155
CP mode 27, 151
CR mode 26, 29, 149, 155
CR+CV 29, 155
current capacity display 53
current monitor signal 104
current range 34
cursor keys 22
CV mode 27, 28, 29, 152, 154, 155

D

date/time setting 120
DC INPUT terminal 14
DC OUT 5V 171
default settings 123
device information 126
digital I/O 103
DIGITAL0 103
DIGITAL1 103
DIGITAL2 103, 115
display 10

E

elapsed time display 53

ESCAPE key 22
EXT CONT connector 92, 93
EXT SYNC port 68
external control 91

F

factory default settings 123
factory default settings, restoring ...
 118, 121
firmware version 126
function keys 20

G

GPIO Converter 171

H

humidity range 138

I

I MON OUT 104
inrush current 138
integrated data 51
interface settings 116
IP address 116, 126
isolation voltage 128, 137

K

key lock 114
KEY LOCK key 114
keyboard 22

L

load input terminal cover
 front panel 17
 rear panel 15
load input terminals
 front panel 17
 rear-panel 15
LOAD key 24
load on/off 24
load value 10
LOCAL key 73
lock 114
logging 47

M

malfunctions and causes 173
manufacturing number 11
MEASURE 9
MEASURE key 19
measurement 47
Memory 59
Menu key 19

N

numeric keypad 22

O

OCP 42
OCPL 42
OCPT 42
operating area 147
operation mode 25
OPP 43, 160
OPPL 43
OPPT 43
outline drawing 139
overcurrent protection 42
overhaul 127
overpower protection 43, 160

P

panel operation 19
panel settings at startup 112
PARALLEL connector 107
parallel operation 105
power capacity display 53
power consumption 138
power on/off 13
POWER switch 13
preset memory 60
program 74, 75
protection 40, 78, 109
protection plate 17, 93, 94

R

remote control 73
remote sensing 56
reset 117, 122
reset settings 123
response speed 54
rotary knob 22

S

-S 57
+S 57
Sanitize 121
SCPI error 119
screen saver 113
sensing cable 56
SENSING connector 56
sensing terminal 56
sequence 74, 88
SEQUENCE key 9, 19
sequence tutorial 84
serial number 11
setup memory 63
short function 36
Slew rate 35

| | |
|------------------------------|--------|
| slew rate | 146 |
| soft start | 55 |
| SOURCE key | 9, 19 |
| step | 74, 80 |
| switching function | 37 |
| synchronized operation | 67 |
| SYSTEM key | 9, 19 |
| system settings | 111 |

T

| | |
|----------------------------|------------|
| temperature range | 138 |
| time setting | 120 |
| time zone | 120 |
| TRIG OUT | 102 |
| trigger | 48, 81, 89 |
| trigger input/output | 102 |
| troubleshooting | 173 |

U

| | |
|-------------------------------|------------|
| undervoltage protection | 44 |
| updating | 125 |
| USB | 8, 22, 125 |
| UVP | 44 |

V

| | |
|---------------------|-----|
| version | 126 |
| voltage range | 34 |

W

| | |
|---------------------------|-----|
| watchdog protection | 45 |
| WDP | 45 |
| weight | 138 |

If you find any misplaced or missing pages in the manuals, they will be replaced. If the manual gets lost or soiled, a new copy can be provided for a fee. In either case, please contact your Kikusui agent or distributor. At that time, inform your agent or distributor of the "Part No." written on the front cover of this manual.

Every effort has been made to ensure the accuracy of this manual. However, if you have any questions or find any errors or omissions, please contact your Kikusui agent or distributor.

After you have finished reading this manual, store it so that you can use it for reference at any time.

KIKUSUI ELECTRONICS CORP.

1-1-3 Higashiyamata, Tsuzuki-ku, Yokohama,
224-0023, Japan

Tel: +81-45-482-6353

Fax: +81-45-482-6261

www.kikusui.co.jp/en

