

User's Manual

Withstanding Voltage/ Insulation Resistance Tester

TOS5300

TOS5301

TOS5302

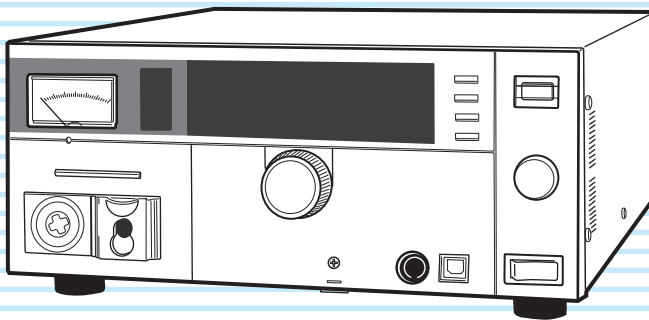

DANGER

This product generates high voltage!

- Improper operation can lead to serious accidents.
- To prevent accidents, be sure to read the section “Safety Precautions during Testing” in this manual.
- Keep this manual close to the product so that the operator can read it at any time.

Thank you for purchasing the TOS5300 Series Withstanding Voltage and Insulation Resistance Tester.

About the Operation Manuals

There are five TOS5300 Series Manuals listed as follows.

■ Setup Guide

This manual is intended for first-time users of this product. It provides an overview of the product and notes on usage. It also explains how to set up the product for testing the DUT. Always read this manual before using the product.

■ Quick Reference

This manual explains Panel description and operation briefly.

■ Safety Information

This document contains general safety precautions for this product. Keep them in mind and make sure to observe them.

■ User's Manual (this manual, PDF)

This manual is intended for first-time users of this product. It provides an overview of the product and notes on usage. It also explains how to configure the product, operate the product, perform maintenance on the product, and so on.

■ Communication Interface Manual (PDF)

This manual contains details about remotely controlling the tester using SCPI commands. This manual is provided on the included CD-ROM.

The interface manual is written for readers with sufficient basic knowledge of how to control measuring instruments using a PC.

PDF files are included in the accompanying CD-ROM.

You can view the PDF files using Adobe Reader.

The newest version of the operation manual can be downloaded from Download service of Kikusui website.

TOS5300 Series Manuals are intended for users of the Withstanding Voltage and Insulation Resistance Tester and their instructors. Explanations are given under the presumption that the reader has knowledge about the electrical aspects of electrical safety testing.

Product firmware versions

This manual applies to products with ROM versions 1.2X.

When contacting us about the product, please provide us with:

- The model (marked in the top section of the front panel)
- The ROM version (see page 24)
- The serial number (marked in the bottom section of the rear panel)

Trademarks

Microsoft, Windows, and Visual Basic are registered trademarks of Microsoft Corporation in the United States and/or other countries.

All company names and product names used in this manual are trademarks or registered trademarks of their respective companies.

Copyrights

The contents of this manual may not be reproduced, in whole or in part, without the prior consent of the copyright holder.

The specifications of this product and the contents of this manual are subject to change without prior notice.

© 2010 Kikusui Electronics Corporation

Notes to the supervisor

- If the operators cannot understand the language used in this manual, translate the manual into the appropriate language.
- Make sure that the operators understand the information in this manual before they operate this product.
- Keep this manual close to the product so that the operators can read the manual at any time.
- If the tester will be used to repeatedly perform tests with fixed conditions, such as when being used as part of a manufacturing line, attach the protection cover to ensure safe operation of the tester. This is useful in preventing incorrect operation of the tester.

Dangerous operations

You will receive a potentially fatal electric shock if:

- You touch an output terminal while output is being generated.
- You touch a test lead that is connected to an output terminal while output is being generated.
- You touch the device under Test (DUT) while output is being generated.
- You touch a location that is electrically connected to an output terminal while output is being generated.
- You touch a location that is electrically connected to an output terminal immediately after output is turned off after an insulation resistance test has been performed.

You may receive a potentially fatal electric shock if:

- You operate the tester without grounding it.
- You operate the tester without using rubber gloves for electrical work.
- You come close to a location that is electrically connected to an output terminal while output is being generated.
- You come close to a location that is electrically connected to an output terminal immediately after output is turned off after an insulation resistance test has been performed.



Safety Precautions

When using this product, be sure to observe the “Safety Precautions” in the Safety information manual.



Precautions Concerning Installation Location

When installing this product, be sure to observe the “Precautions Concerning Installation Location” in the Safety information manual. The following precautions pertain only to this product.

- When installing this product, be sure to observe the temperature and humidity ranges indicated below.
 - Operating temperature range: 0 °C to +40 °C (32 °F to 104 °F)
 - Operating humidity range: 20 %rh to 80 %rh (no condensation)
- When storing this product, be sure to observe the temperature and humidity ranges indicated below.
 - Storage temperature range: -20 °C to +70 °C (-4 °F to 158 °F)
 - Storage humidity range: 90 %rh or less (no condensation)
- Do not use the product in a poorly ventilated location. The product uses forced air cooling. It sucks air into the inlet holes on its right, rear, and bottom panels, and then expels air through its rear panel. Secure adequate space around the product’s inlet and outlet holes to prevent the possibility of fire caused by accumulation of heat. Allow at least 20 cm of space between the inlet and outlet holes on the side and rear panels and the walls (or obstacles). Paper, vinyl, or any other product that may be easily sucked into the inlet holes must not be placed between the inlet holes on the bottom panel and the floor or stand that the product is installed on. Hot air (approximately 20 °C or 68 °F hotter than the ambient temperature) is expelled from the outlet hole. Do not place objects that are affected by heat near the air outlet.

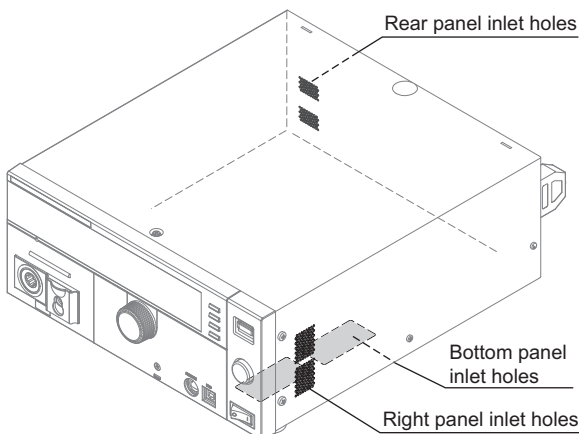

- Do not use the product near highly sensitive measuring instruments or receivers. The noise generated by the product may affect these other devices. At a test voltage of 3 kV or greater, the product may produce corona discharge between its test lead clips. This will generate a significant amount of broadband RF emission. To minimize this effect, keep the alligator clips away from each other. Also, keep the alligator clips and test leads away from conducting surfaces, especially sharp metal edges.

Notations Used in This Manual

- The TOS5300 Series Withstanding Voltage and Insulation Resistance Tester is also referred to as the TOS5300 Series.
- Device under test is also referred to as DUT.
- The term “PC” is used to refer generally to both personal computers and workstations.
- The following markings are used in the explanations in the text.

WARNING

Indicates a potentially hazardous situation which, if ignored, could result in death or serious injury.

CAUTION

Indicates a potentially hazardous situation which, if ignored, may result in damage to the product or other property.

NOTE

Indicates information that you should know.

DESCRIPTION

Explanation of terminology or operation principle.

See

Indicates a reference to detailed information.

SHIFT+key name (blue letters)

Indicates an operation that requires you to press a key indicated in blue letters while holding down the SHIFT key.

SHIFT+MEMORY x (MEMORY 1 to MEMORY 3)

Indicates an operation that requires you to press a memory key (MEMORY 1 to MEMORY 3) while holding down the SHIFT key.

5300

Indicates a feature or message that is only available on the TOS5300 model.

5301

Indicates a feature or message that is only available on the TOS5301 model.

5302

Indicates a feature or message that is only available on the TOS5302 model.

★ Memo

Indicates useful information.

Contents

About the Operation Manuals	2
Notes to the supervisor	3
Dangerous operations	3
Safety Precautions	4
Precautions Concerning Installation Location	4
Notations Used in This Manual	4
Search by Topic.....	8
Front Panel.....	10
Rear Panel.....	12

1 General Description

Product Overview	14
Features	14
Options.....	16

2 Installation and Preparation

Checking the Package Contents	20
Connecting the Power Cord	21
Using the Protection Cover.....	22
Turning the Power On.....	23
Checking indicators and the status of the interlock feature	23
Turning the POWER switch on	24
Turning the POWER switch off.....	25
Performing the zero adjustment before testing.....	25
Connecting to the Device under Test (DUT).....	26
Using test leads.....	26
Using the optional high voltage test probe (model HP01A-TOS/HP02A-TOS).....	28
Disconnecting test leads from the DUT.....	28

3 Safety Precautions during Testing

Pre-Test Inspection.....	30
Testing Precautions.....	30
Remote Control Precautions.....	31
Precautions after Output Has Been Turned Off	31
Interrupting Testing or Operations	32
Emergency Measures	32
Forbidden Actions	32
Turning the power on and off repeatedly	32
About Malfunctions	33
To Use the Product for a Long Time Free of Malfunctions	33

4 Panel Operation Basics

Parts of the Screen.....	36
Panel Operations.....	38

Switching between screens.....	38
Selecting settings	39
Entering values.....	39
Locking panel operations (key lock).....	40
Selecting the Test Mode	41
Single test (ACW, DCW, or IR).....	41
Auto test (AUTO TEST)	41
Panel Memory.....	42
Saving test conditions	43
Recalling test conditions.....	44

5 Withstanding Voltage and Insulation Resistance Tests

About Judgment	46
Effectiveness of the upper and lower limits.....	46
Invalid Settings.....	46
Setting Withstanding Voltage Test Conditions.....	47
AC withstanding voltage test (ACW) settings.....	47
DC withstanding voltage test (DCW) settings	48
Setting Insulation Resistance Test Conditions.....	49
Insulation resistance test (IR) settings.....	49
Auto Test (AUTO TEST)	50
Setting Other Test Conditions	51
Start voltage	51
Voltage rise time	52
Voltage fall time	52
Frequency	52
Current detection response speed	52
Judgment wait time (Wait Time)	53
Selecting Measurement Method	54
Saving the Calibration Date.....	55
Setting Other Test Features.....	56
Double action feature	56
Length of time to maintain a PASS judgment result	56
Momentary feature.....	57
Fail mode feature.....	57
Buzzer volume	57
Starting Testing.....	58
To start testing.....	58
When testing starts.....	58
To change the voltage setting during testing	59
If you cannot start testing	60
Stopping Testing	60
To stop testing.....	60
When testing finishes.....	61
To clear judgment results.....	61

6 External Control

SIGNAL I/O Connector.....	64
SIGNAL I/O specifications.....	64
Internal construction	66
Input signal usage example	66
Output signal usage example	66
Starting Testing	67
Recalling Panel Memory and Test Modes	67
Interlock Feature	68
How to use the interlock feature.....	69
STATUS OUT Connector	69

7 Maintenance

Pre-Test Inspection.....	72
Inspection of test leads and the judgment feature	72
Time Settings and Calibration Management.....	73
Calibration	74
Backup Battery Replacement	74

8 Specifications

Withstanding voltage tester	76
Insulation resistance test section	79
Other features	81
Interfaces.....	82
General.....	83
Outline drawing.....	84

Appendix

A List of Default Settings	86
Initializing the TOS5300 Series.....	86
Default panel memory values	87
B Configuration Settings	88
Test Mode and Buzzer settings.....	89
Status Signal Output settings.....	90
Date and Time settings.....	91
Communication display items	92
Information display items.....	92
C Protective Features	93
D Timing chart	94
PASS judgment.....	94
FAIL judgment	99
Takt time	100
E Troubleshooting.....	101

Index	103
-------------	-----

Preparation



- **What accessories are included in the package?**
→ "Checking the Package Contents" *p.20*
- **Before I start testing, I want to check that the TOS5300 Series is operating safely.**
→ "Turning the Power On" *p.23*
- **How do I use each of the two test leads?**
→ "Using test leads" *p.26*
- **I want to check that measurements are being performed correctly before I start testing.**
→ "Pre-Test Inspection" *p.72*
- **I want to know more about the interlock feature.**
→ "Interlock Feature" *p.68*

Setup



- **Other than the basic settings that are set from the panel, what test conditions can be set?**
→ "Setting Other Test Conditions" *p.51*
→ "Configuration Settings" *p.88*
- **How are measured values judged?**
→ "About Judgment" *p.46*
- **How does the TOS5300 Series display the judgment results?**
→ "When testing finishes" *p.61*
- **How do I keep the TOS5300 Series in the PASS state?**
→ "Length of time to maintain a PASS judgment result" *p.56*

Operation

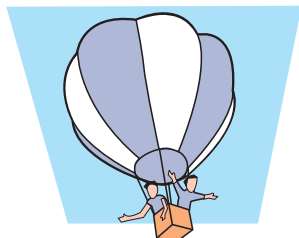

- **How do I save the current test conditions and use them later?**
→ "Panel Memory" *p.42*
- **How do I start tests with a greater level of safety?**
→ "Double action feature" *p.56*
- **How do I prevent unintentional key operations from changing the test conditions?**
→ "Using the Protection Cover" *p.22*
→ "Locking panel operations (key lock)" *p.40*
- **How do I perform consecutive tests by switching test modes between each test?**
→ "Auto Test (AUTO TEST)" *p.50*
- **How do I control the TOS5300 Series by applying external signals?**
→ "SIGNAL I/O Connector" *p.64*
- **How do I release the interlock feature?**
→ "Turning the Power On" *p.23*

Maintenance



- **How do I check that the test leads are not damaged (for example, that they have no breaks)?**
→ "Pre-Test Inspection" *p.72*
- **How do I check when calibration was last performed?**
→ "Time Settings and Calibration Management" *p.73*
- **How do I change the next scheduled calibration date?**
→ "Time Settings and Calibration Management" *p.73*
- **How do I set the system clock?**
→ "Time Settings and Calibration Management" *p.73*

Troubleshooting

See "Troubleshooting" on page 101.

Front Panel

TOS5300 front panel

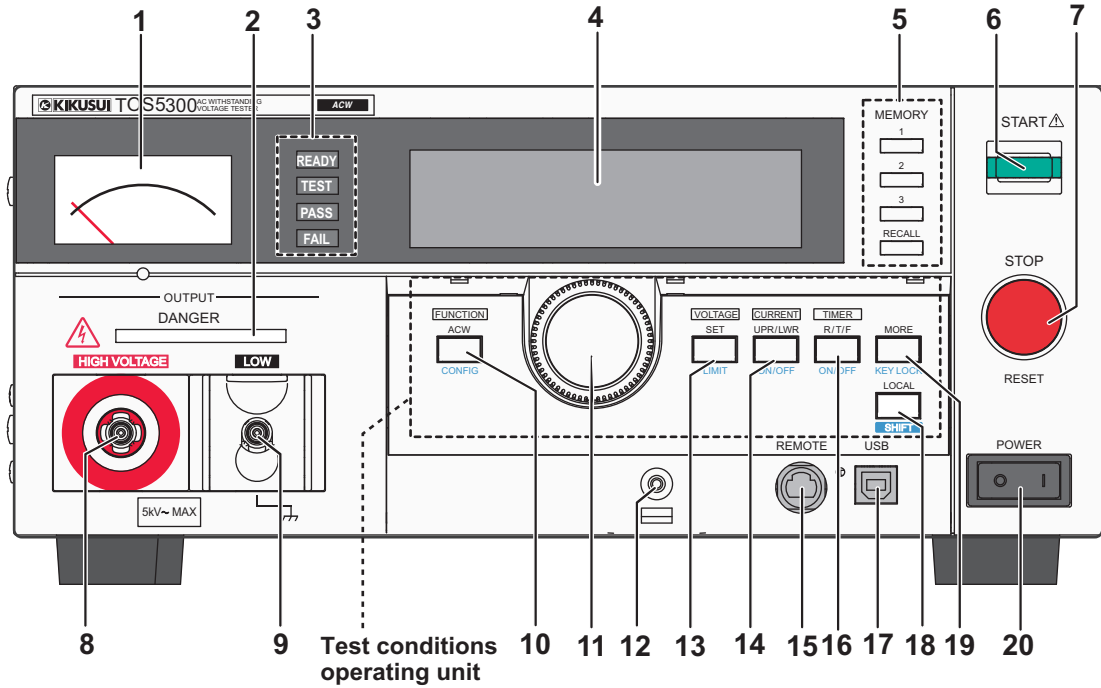

The protection cover is attached to the TOS5300 Series when the product is shipped from the factory.

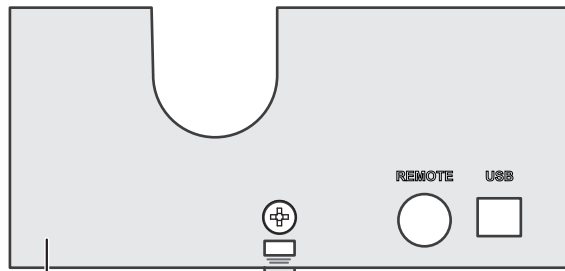

Loosen the screw, and pull this part towards you to remove the cover.

TOS5301 test conditions operating unit

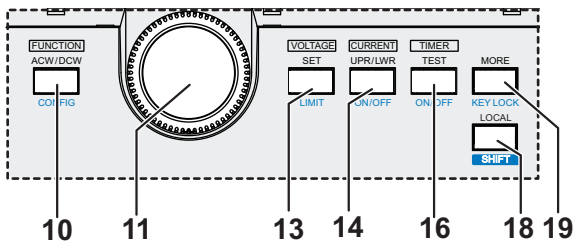

TOS5302 test conditions operating unit

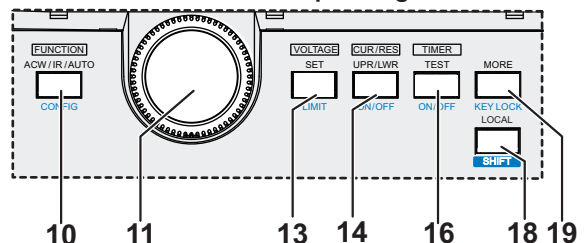

No.	Name	Function	See
1	Analog voltmeter	A voltmeter that indicates the output voltage.	p.23
2	DANGER LED	Lights in red when testing is being performed.	p.58

No.	Name	Function		
3	Status indicators	READY: Lights in light blue when the TOS5300 Series is ready to perform a test.	<i>p.58</i>	
		TEST: Lights in red when testing is being performed.	<i>p.58</i>	
		PASS: Lights in green when a test passes.	<i>p.61</i>	
		FAIL: Lights in yellow when a test fails.	<i>p.61</i>	
4	Display	Displays the settings, measured values, and other information.	<i>p.36</i>	
5	MEMORY keys	Press these keys to display the settings that are saved to memory. When test conditions or configuration items are being set, these keys correspond to the menus displayed on the screen.		
		MEMORY 1 key: Displays the settings saved to MEMORY 1. MEMORY 2 key: Displays the settings saved to MEMORY 2. MEMORY 3 key: Displays the settings saved to MEMORY 3. RECALL key: Recalls settings from panel memory. + SHIFT key: Saves the current settings to panel memory. ¹	<i>p.42, p.88</i>	
6	START switch	Starts testing.	<i>p.58, p.78</i>	
7	STOP switch	Stops testing and clears the current status.	<i>p.60</i>	
8	HIGH VOLTAGE terminal	This terminal is for the high line of the tester output.	<i>p.26</i>	
9	LOW VOLTAGE terminal	This terminal is for the low line of the tester output (with cable lock).	<i>p.26</i>	
10	Function key	Switches between test modes. TOS5300: ACW key TOS5301: ACW/ DCW key TOS5302: ACW/ IR/ AUTO key	<i>p.38, p.41, p.47, p.49, p.50</i>	
	CONFIG key	Displays the configuration setup screen.	<i>p.88</i>	
11	Rotary knob	Changes settings.	<i>p.39</i>	
12	Screw hole	Fasten a screw to this hole to fix the protection cover in place.	—	
13	SET key	Press to select the voltage setting.	<i>p.39</i>	
	LIMIT key	Press to select the voltage limit setting.	<i>p.39</i>	
14	UPR/ LWR key	TOS5300/TOS5301: Press to select the upper and lower current limits. TOS5302: Press to select the upper and lower current and resistance limits. +SHIFT key: Turns the lower current limit on and off. ¹	<i>p.39</i>	
	ON/ OFF key	Turns the lower limit judgment feature on and off.	<i>p.39</i>	
15	REMOTE connector	Specialized connector for connecting the optional remote control box, RC01-TOS/ RC02-TOS, or the high voltage test probe, HP01A-TOS/HP02A-TOS.	<i>p.16, p.28</i>	
16	TEST key	Press to select the test time (Test Time).	<i>p.39</i>	
	ON/ OFF key	Turns the test time (Test Time) on and off.	<i>p.39</i>	
17	USB port	This is the USB interface.	—	
18	LOCAL key	Switches between local mode and remote mode.	—	
	SHIFT key	Used to access the features that are written in blue.	—	
19	MORE key	Selects additional test condition settings. ACW: Start voltage (Start Voltage), rise time (Rise Time), fall time (Fall Time), and frequency (Frequency). DCW: Start voltage (Start Voltage), rise time (Rise Time), and the time to wait before making judgments (Wait Time). IR: The time to wait before making judgments (Wait Time) and current detection response speed (Response).	<i>p.39, p.51</i>	
		KEY LOCK key	Locks panel key operations (settings and changes).	<i>p.40</i>
		20	POWER switch	Turns the power on [I] and off [O].
21	Protection cover	Cover designed to prevent incorrect operation of the TOS5300 Series.	<i>p.22</i>	

¹ This indicates an operation that requires you to press a key while holding down the SHIFT key.

Rear Panel

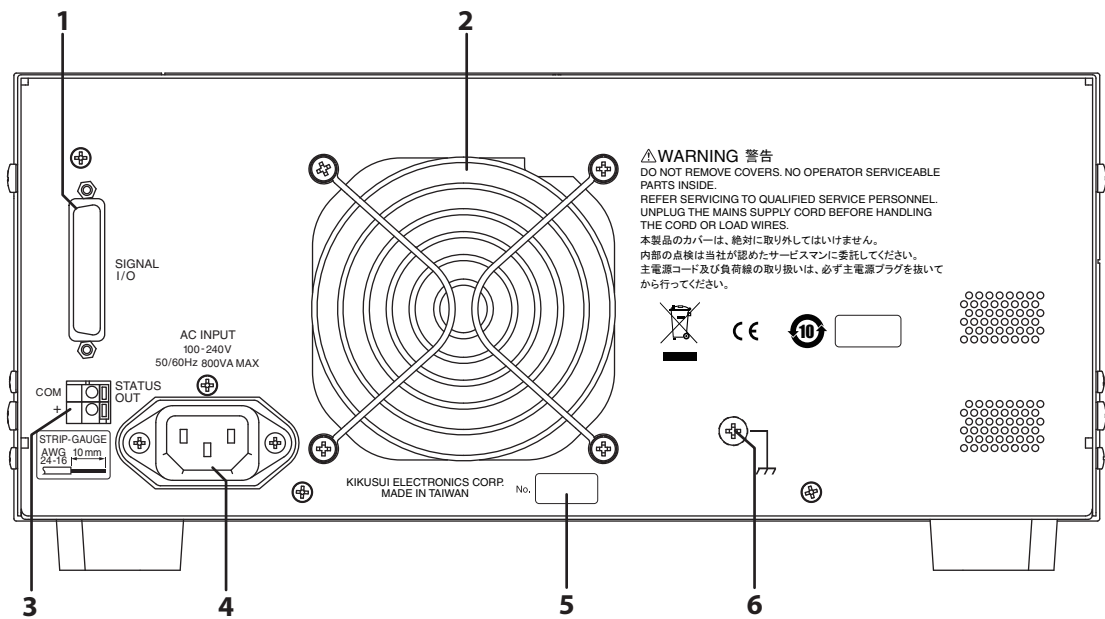

No.	Name	Function	See
1	SIGNAL I/O connector	External control signal connector.	p.64
2	Air outlet	Vent for cooling the TOS5300 Series.	—
3	STATUS OUT connector	Connector for connecting the optional warning light unit, PL02-TOS.	p.17, p.69
4	AC LINE connector	AC inlet.	p.21
5	Serial number	This is the serial number of the TOS5300 Series.	—
6	Chassis terminal	Terminal for grounding the product when it cannot be grounded through the power cord.	—



1

General Description

This chapter gives an overview of the TOS5300 Series and explains the options that are available for it.

Product Overview

The TOS5300 Series Withstanding Voltage and Insulation Resistance Testers perform withstanding voltage and insulation resistance tests, which are two of the four tests that are required for ensuring the safety of electrical products.¹

This product can perform withstanding voltage and insulation resistance tests on electrical products and electrical components in accordance with the requirements of safety and electrical standards and ordinances such as IEC, EN, UL, VDE, and JIS.

It is suited to (1) research and development installations, (2) test facilities for quality assurance testing and standard certification, and (3) manufacturing lines.

The TOS5300 can perform AC withstanding voltage tests (ACW). The TOS5301 can perform AC withstanding voltage tests and DC withstanding voltage tests (ACW and DCW). The TOS5302 can perform AC withstanding voltage tests (ACW) and insulation resistance tests (IR).

These withstanding voltage and insulation resistance testers are easy to use, safe, and reliable.

Features

- **Newly developed constant-voltage output for stable testing**

The TOS5300 Series is not affected by AC line interference. Because the output voltage is maintained at a fixed value even if the AC line voltage or frequency changes, stable tests can be performed even in locations where the power supply is unstable.

The AC inlet is designed for worldwide use. The TOS5300 Series can be used without modification provided the nominal power supply voltage is within the range of 100 VAC to 240 VAC (90 VAC to 250 VAC)

and the frequency is within the range of 47 Hz to 63 Hz.

- **Rise time control feature that gradually increases the test voltage (only for withstanding voltage tests)**

Instead of immediately applying the specified test voltage to the DUT after the test begins, this makes it possible to perform tests in which the voltage is raised gradually to the test voltage. As required by withstanding voltage tests defined by standards such as IEC and UL, this makes it possible to perform tests in which no more than half of the test voltage is applied at the start of the test, and the test voltage is gradually reached over the specified time.

- **Fall time control feature that gradually decreases the test voltage**

The test voltage can be gradually decreased after a PASS judgment occurs during an AC withstanding voltage test.

- **Auto test (AUTO TEST) for performing consecutive tests** 5302

A combination of an AC withstanding voltage test and an insulation resistance test (IR) can be performed in sequence.

- **Calibration Protection feature that provides a notification when TOS5300 Series calibration is required**

The product displays a message when the preset calibration period elapses. It is also possible to switch the product into protection mode and apply limits to its use when this period elapses.

¹ The four tests are the withstanding-voltage, insulation-resistance, earth-continuity, and leakage-current tests.

- **Window comparator feature for setting upper and lower judgment limits**

You can set not only the upper limit, but the lower limit as well. This is useful in determining whether there are breaks in test leads or whether there was a mistake during operations. This leads to highly reliable tests.
- **Ability to save three sets of test conditions**

Up to three sets of test conditions for single tests (AC withstanding voltage tests, DC withstanding voltage tests, and insulation resistance tests) and auto tests (an insulation resistance test followed by a withstanding voltage test and a withstanding voltage test followed by an insulation resistance test) can be saved.
- **Improved safety**

In addition to having features that enable you to view the output voltage, the TOS5300 Series also enables you to set the voltage limits, so you can prevent a voltage greater than what is necessary from being generated unintentionally. This provides protection for the DUT.
- **Standard-equipped USB port**

The TOS5300 Series is standard-equipped with a USB interface. You can use a PC or sequencer to control test conditions and read measured values and test results.
- **Easier to read**

The LED graphic display is easy to read. Additionally, when a protective feature is activated, the reason for its activation is easily viewable on the display.
- **Light-weight and easy to move**

Even though the TOS5300 Series can generate 500 VA, which is sufficient for performing withstanding voltage tests, it weighs at most 15 kg, so it can be moved by even a single person.
- **Protection against incorrect operations**

In addition to the key lock feature, the TOS5300 Series has a protection cover for the part of its panel that is used to change test conditions. This cover is useful in preventing incorrect operations when you want to perform tests with fixed conditions.

Options

The following options are available for the TOS5300 Series.
For information about options, contact your Kikusui agent or distributor.

Rack mount option

Name	Model	Notes
Rack mount adapter	KRA4-TOS	For an EIA inch rack
	KRA200-TOS	For a JIS millimeter rack

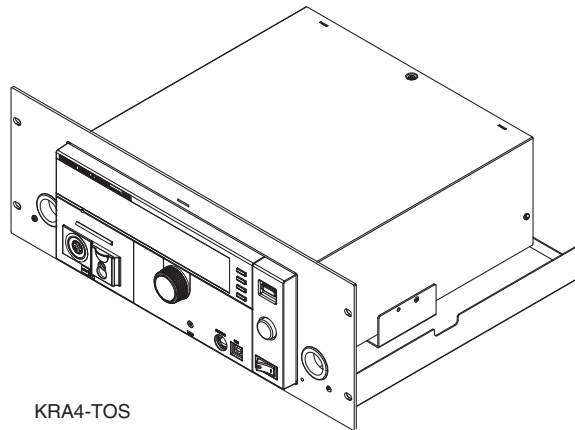

KRA4-TOS

Model RC01-TOS/RC02-TOS remote control box

The remote control box can be used to start and stop withstanding voltage and insulation resistance tests. One model is for use with one hand, and the other model is for use with two hands. A DIN adapter cable is required to connect to the TOS5300 Series.

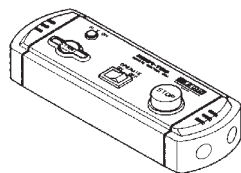

RC01-TOS (one hand)

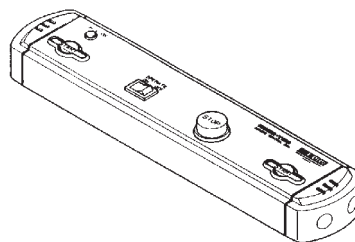

RC02-TOS (two hands)

Model DD-5P/ 9P DIN adapter cable

The DD-5P/9P DIN adapter cable (5 pin to 9 pin) is for connecting the following option products to the TOS5300 Series.

- Remote control box (RC01-TOS/RC02-TOS)
- High voltage test probe (HP01A-TOS/HP02A-TOS)

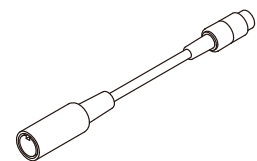

See p.28

Model HP01A-TOS/HP02A-TOS high voltage test probe

This is a probe for generating the test voltage. To prevent the test voltage from being generated unintentionally, this probe has been designed so that the test voltage is only generated when the user operates the probe with both hands.

A DIN adapter cable is required to connect to the TOS5300 Series.

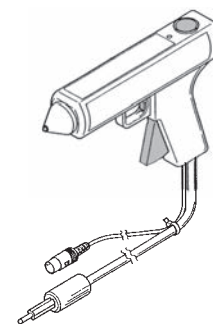

The maximum rated voltages of the HP01A-TOS/HP02A-TOS are 4 kVac and 5 kVdc. For safety reasons, set the Limit Voltage (LIMIT) (p.42) to limit the applied voltage.

Model PL02-TOS warning light unit

The warning light unit indicates that the TOS5300 Series is performing a test. This enables you to see that a test is in progress from a distance.

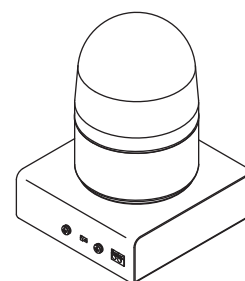



This page is intentionally blank.





2

Installation and Preparation

This chapter describes how to unpack and prepare this product before you use it.

Checking the Package Contents

When you receive the product, check that all accessories are included and that the accessories have not been damaged during transportation.

If any of the accessories are damaged or missing, contact your Kikusui agent or distributor.

We recommend that you save all packing materials, in case the product needs to be transported at a later date.

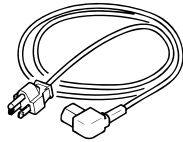

Rated: 125 Vac, 10 A
PLUG: NEMA5-15
[85-AA-0003]

- Power cord (1 pc.)
Length: Approx. 2.5 m

or

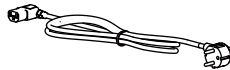

Rated: 250 Vac, 10 A
PLUG: CEE7/7
[85-10-1070]

or

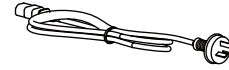

Rated: 250 Vac, 10 A
PLUG: GB1002
[85-10-0791]

The power cord that is provided varies depending on the destination for the product at the factory-shipment.

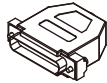

- SIGNAL I/O plug (1 set)
Assembly type
(D-sub plug unit)



- High-voltage warning
sticker (1 pc.)

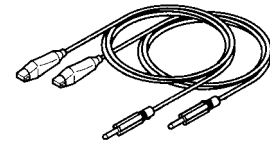

- High-voltage test lead (1 set)
[TL31-TOS]

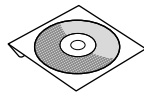

- CD-ROM (1 pc.)

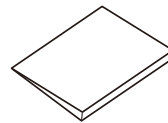

- Setup guide (1 pc.)

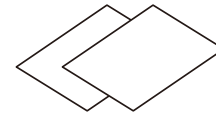

- Japanese: 1pc.
English: 1pc.
- Quick Reference

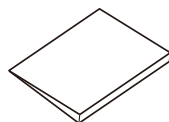

- Safety information (1pc.)

Connecting the Power Cord



- **This product is a piece of equipment that conforms to IEC Safety Class I (equipment that has a protective conductor terminal). Be sure to earth ground the product to prevent electric shock.**
- **The product is grounded through the power cord ground wire. Connect the protective conductor terminal to earth ground.**

NOTE

- Use the supplied power cord to connect to the AC line. If the supplied power cord cannot be used because the rated voltage or the plug shape is incompatible, have a qualified engineer replace it with an appropriate power cord that is 3 m or less in length. If obtaining a power cord is difficult, contact your Kikusui agent or distributor.
- The power cord with a plug can be used to disconnect the product from the AC line in an emergency. Connect the plug to an easily accessible power outlet so that the plug can be removed from the outlet at any time. Be sure to provide adequate clearance around the power outlet.
- Do not use the supplied power cord for other devices.

This product is a piece of equipment that conforms to IEC Overvoltage Category II (energy-consuming equipment that is supplied from a fixed installation).

In addition to the supplied power cord, Kikusui also provides other 200 V power cords with plugs (sold separately).

- 1 Check that the POWER switch is turned off.**
- 2 Check whether the AC power line is compatible with the input rating of the product.**

The product can receive a nominal power supply voltage in the range of 100 VAC to 240 VAC (90 VAC to 250 VAC) that has a frequency in the range of 47 Hz to 63 Hz.
- 3 Connect the power cord to the rear-panel AC inlet, and then connect the power plug to an outlet that has a ground terminal.**

Using the Protection Cover

When the product is shipped from the factory, a protection cover is attached to the front panel. This cover prevents unintentional changes to the test conditions. Remove this cover when you want to set the test conditions.

Even when the cover is attached, you can still recall settings from memory, start and stop tests, perform remote operations, and control the TOS5300 Series through its USB port. If the tester will be used to repeatedly perform tests with fixed conditions, such as when being used as part of a manufacturing line, attach the protection cover to ensure safe operation of the tester. This is useful in preventing incorrect operation of the tester.

If the cover is damaged or lost, contact your Kikusui agent or distributor.

■ Removing the protection cover

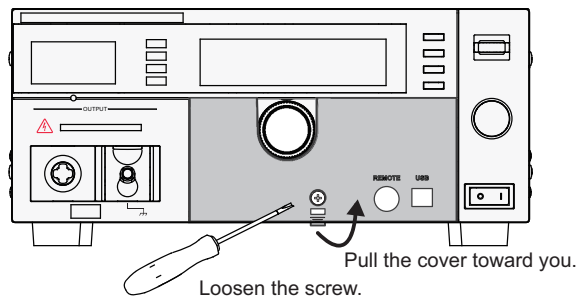

Loosen the screw, and then pull the hook centered at the bottom of the cover towards you to remove the protection cover from the panel.

■ Attaching the protection cover

Insert the tabs at the top of the cover into the slots in the panel, push the bottom part of the cover until it is attached to the panel, and then use the screw to fix the cover in place.

■ Storing the protection cover

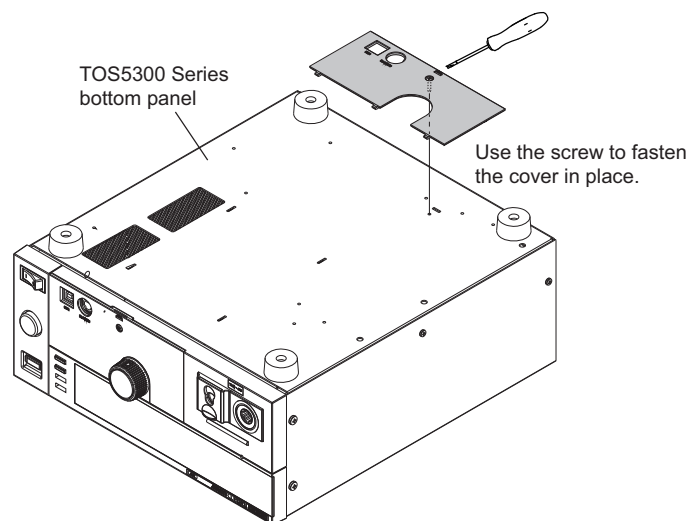

When you want to use the TOS5300 Series without the protection cover attached, such as when you will repeatedly perform tests with frequently changed test conditions, you can store the protection cover on the product's bottom panel. This is useful in preventing the cover from being lost.

Use the screw to fix the cover to the product's bottom panel.

Turning the Power On

Checking indicators and the status of the interlock feature

See p.69

The first time that you turn the POWER switch on after you purchase the TOS5300 Series, the tester will be in PROTECTION mode through the interlock feature. Connect the included SIGNAL I/O plug to the SIGNAL I/O connector to release the interlock feature.

See p.69

Only use the included SIGNAL I/O plug to easily release the PROTECTION mode.

When you are actually performing tests, use the interlock feature to ensure safety.

During withstanding voltage and insulation resistance tests in which you are using tools, (1) placing a cover over the DUT so that output is turned off whenever the cover is removed to prevent electric shock and (2) placing a safety fence around the work area where withstanding voltage and insulation resistance tests are being performed so that output is turned off whenever the fence is opened are both examples of effective safety measures.

NOTE

When the TOS5300 Series is turned on, a self-test is run, and all the indicators on the front panel light. To ensure safety, check that all the indicators light before you use the TOS5300 Series. It is especially dangerous to use the tester if its DANGER LED is broken.

When the power is turned on, the DANGER LED lights, but no voltage is generated.

See p.21

- 1 Check that the power cord and all cables are correctly connected.
- 2 Check that nothing is connected to the SIGNAL I/O connector.
- 3 Check that the analog voltmeter is indicating "0."

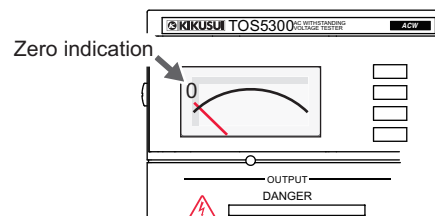

- 4 Press the (|) side of the front-panel POWER switch to turn the TOS5300 Series on.

Check that all the front-panel indicators light.

The firmware version screen will be displayed for a few seconds, and then a message indicating that the TOS5300 Series is in PROTECTION mode will be displayed.

Check that the tester is in PROTECTION mode through the interlock feature.

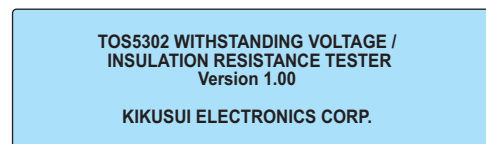

Firmware version screen

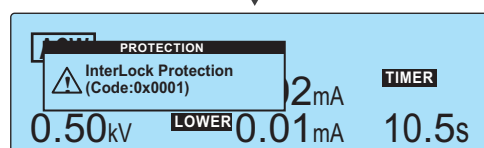

Interlock protection mode

- 5 Press the (O) side of the front-panel POWER switch to turn the TOS5300 Series off.

Turning the POWER switch on

1 Connect the included SIGNAL I/O plug to the SIGNAL I/O connector.
Connecting the SIGNAL I/O plug will release the interlock feature.

2 Check that the analog voltmeter is indicating "0."

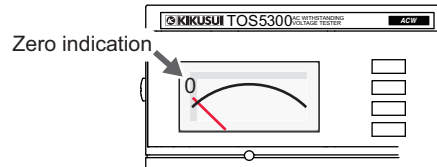

3 Turn the POWER switch on (|).

4 Check the firmware version (Ver x.xx) that is displayed on the screen.
Check that the firmware version screen is displayed for a few seconds, that the setup screen for setting the AC withstanding voltage test conditions is displayed thereafter, and that the tester is then in READY mode (that the READY LED lights).

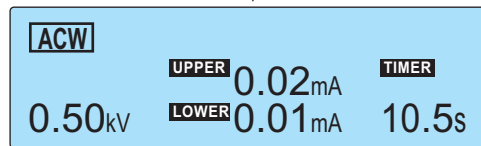

5 Check that the analog voltmeter is indicating "0."

See p.86

The first time that the POWER switch is turned on, the firmware version is displayed, and then the setup screen for setting the AC withstanding voltage test conditions is displayed (with the factory default settings).

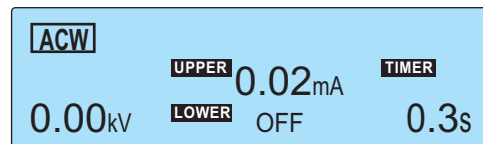

The product stores the settings that are in use before it is turned off, so the next time that the POWER switch is turned on, the TOS5300 Series starts with these settings.

About the system clock

The TOS5300 Series keeps track of the scheduled calibration date by using the internal system clock. When the tester is turned on after the previously set calibration period has elapsed, a message alerting you of this fact is displayed.

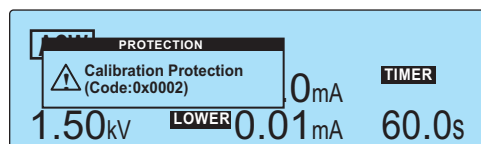

See p.73

For details on how to set the system clock and what to do when the calibration period has elapsed, see "Time Settings and Calibration Management."

Turning the POWER switch off

Press the (O) side of the POWER switch to turn the TOS5300 Series off.

The panel settings that were in use immediately before the POWER switch was turned off are saved. If the POWER switch is turned off immediately after the settings have been changed, the last settings may not be stored.



WARNING

Possible electric shock.

- After you turn the POWER switch off, wait at least 10 seconds before you turn the POWER switch back on. It is dangerous to do otherwise, because the protective features of the product may not work effectively. This may cause the product to malfunction, and it may reduce the life of the POWER switch and internal parts such as the fuses.
- Except in an emergency, do not turn the POWER switch off while output is being generated.

Performing the zero adjustment before testing

If the analog voltmeter does not indicate "0," perform this adjustment.

- 1 Check that the POWER switch is turned off (O).
- 2 Use the analog voltmeter's zero adjuster to set the needle to the correct position.

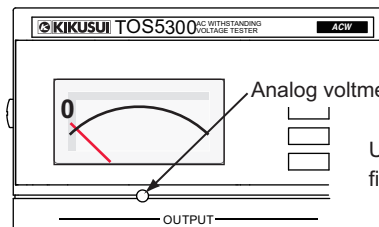

Use a flat-blade screwdriver or other fine-tipped tool to turn the adjuster.

Connecting to the Device under Test (DUT)



WARNING Possible electric shock. During testing (while the TEST LED or DANGER LED is lit), never touch the HIGH VOLTAGE terminal, test leads, and DUT.

Using test leads



WARNING Possible electric shock.

- Parts of the included test leads near the alligator clips protrude from the vinyl insulation when the wires are connected. These parts are dangerous. Never come close to these parts during testing.
- If connections are incomplete, the entire DUT may be charged to a high voltage. This is dangerous, so be sure to connect the DUT correctly.
- Be sure to connect the LOW test lead (black) first.

Never touch these parts during testing.

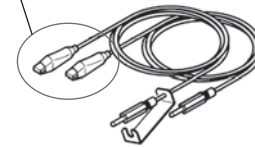

CAUTION Connecting the low and high voltage terminals incorrectly may lead to malfunctions. A plate that is designed to prevent incorrect connections to these terminals is attached to the LOW test lead (black). Do not remove this plate.

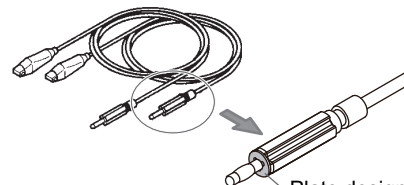
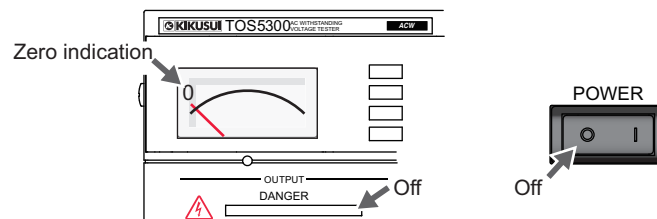

Plate designed to prevent incorrect connections

- 1** Check that the POWER switch is off, that the analog voltmeter is indicating "0," and that the DANGER LED is off.



See p.72

- 2** Check that there are no tears or breaks in the test lead insulation.
- 3** Raise the front-panel LOW VOLTAGE terminal's cable lock, and then connect the LOW test lead (black).

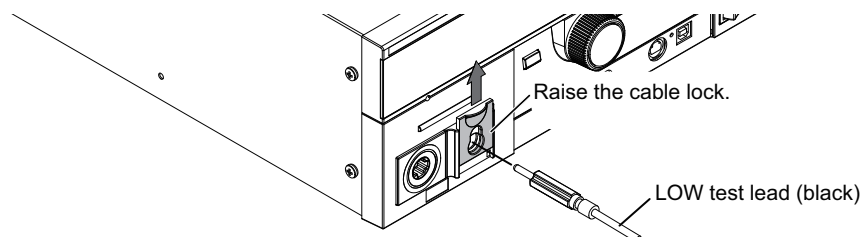

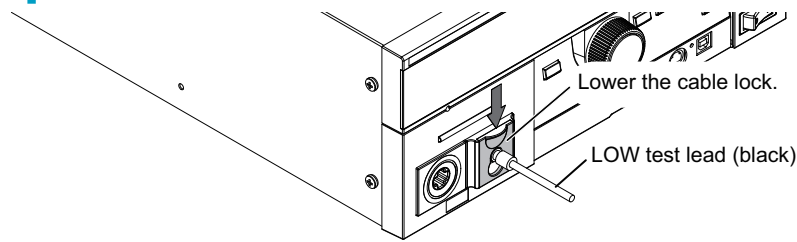
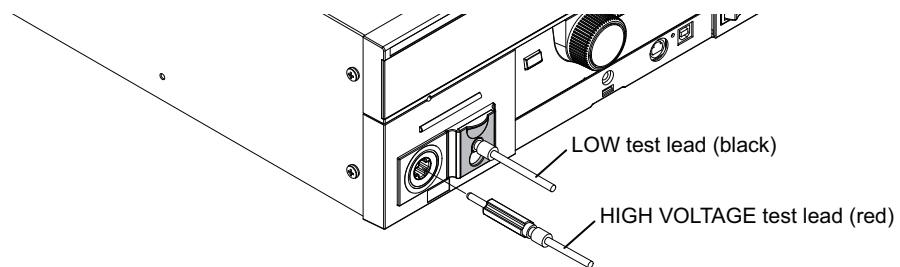
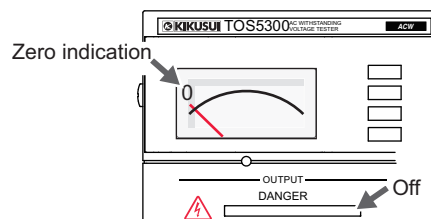
4 Lower the cable lock to secure the lead in place.**5 Connect the LOW test lead (black) to the DUT.****6 Connect the HIGH VOLTAGE test lead (red) to the DUT.****7 Connect the HIGH VOLTAGE test lead (red) to the front-panel HIGH VOLTAGE terminal.****8 Check that the analog voltmeter is indicating "0" and that the DANGER LED is off.****Reducing the effect of noise**

Noise may be generated if the outputs are shorted or if the DUT insulation is damaged. Electronic devices in the surrounding area may malfunction due to the effect of this noise. To reduce the effect of noise, connect a toroidal core or a resistor of approximately $470\ \Omega$ between the tips of the HIGH VOLTAGE and LOW test leads and the DUT. Connect the toroidal core or resistor as close to the DUT as possible.

If you are connecting a toroidal core, it is effective to wrap the test leads two to three times around a type of core that can be snapped on and that is often used with power cables. This type of core is usually approximately 20 mm in diameter.

If you are connecting a resistor, pay close attention to the power rating of the resistor. When the upper limit is 10 mA or less, connect a resistor of approximately $470\ \Omega$ (3 W, 30 kV impulse withstanding voltage). Because this resistor causes the voltage to fall, the voltage that is actually applied to the DUT is slightly lower than the voltage that is generated from the product's output terminals (when a 10 mA current flows, the voltage falls approximately 10 V).

These methods are extremely useful in reducing the effect of noise.

Connect the toroidal core or resistor as close to the DUT as possible.

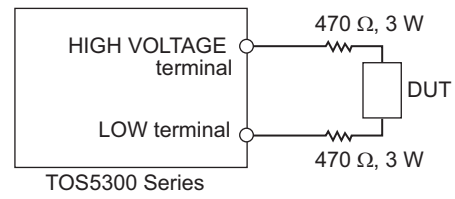
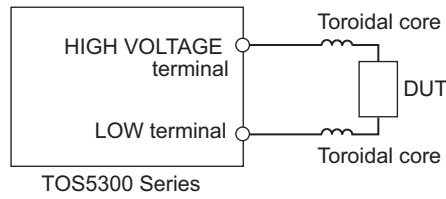

Using the optional high voltage test probe (model HP01A-TOS/HP02A-TOS)

See p.17

If you use the optional test probe instead of the test leads, you can use hands-on control to start tests. For details, see the "OPERATION MANUAL HIGH VOLTAGE TEST PROBE HP01A-TOS/HP02A-TOS."

Disconnecting test leads from the DUT

- 1** Check that the analog voltmeter is indicating "0" and that the DANGER LED is off.
- 2** Disconnect the HIGH VOLTAGE test lead (red) from the front-panel HIGH VOLTAGE terminal.
- 3** Disconnect the HIGH VOLTAGE test lead (red) from the DUT.
- 4** Disconnect the LOW test lead (black).
You can disconnect the LOW test lead (black) first from either the DUT or the TOS5300 Series.



3

Safety Precautions during Testing

This chapter describes the precautions that must be followed to perform tests safely.

Pre-Test Inspection



WARNING

Possible electric shock.

- During testing, this product supplies a voltage of at least 5 kVAC or 6 kVDC to an external device. Handling this tester improperly may lead to a fatal accident. To prevent accidents, strictly follow the precautions and always pay the utmost attention to safety concerns when you operate the TOS5300 Series.
- This product is a piece of equipment that conforms to IEC Safety Class I (equipment that has a protective conductor terminal). Be sure to earth ground the product to prevent electric shock.
- The product is grounded through the power cord ground wire. Connect the protective conductor terminal to earth ground.
- During testing, be sure to wear rubber gloves for electrical work.

Check the following items before you start testing, and always follow the precautions.

- The power cord is connected to a properly grounded outlet.
- There is no damage such as tears or breaks in the test lead insulation.
- When the POWER switch is turned on, the DANGER LED and the status indicators light.
- During testing, do not touch the items that are charged to a high voltage: the DUT, the test leads, and the areas near the output terminals.
- During testing, do not turn the POWER switch off except in an emergency.

Testing Precautions

During tests, the TEST and DANGER LEDs light. When these LEDs are lit, the TOS5300 Series is generating a high voltage. During testing, be sure to wear rubber gloves for electrical work. If obtaining these gloves is difficult, contact your Kikusui agent or distributor.

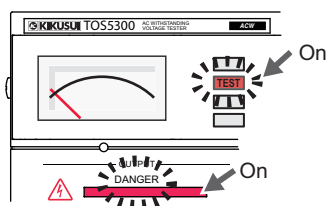

The TEST and DANGER LEDs light. The TEST LED lights in red.

Remote Control Precautions

When you are controlling the TOS5300 Series remotely, external signals are used to turn the high voltage on and off. To prevent accidents, follow the safety measures given below.

- **Make sure that high voltages are not generated unintentionally.**
- **Make it impossible to touch the DUT, test leads, test probes, and the areas near the output terminals when high voltages are being generated.**

Precautions after Output Has Been Turned Off



Possible electric shock.

- **For a short time after the output has been turned off, do not touch the items that have been charged to a high voltage, such as the DUT, the test leads, the test probes, and the areas near the output terminals.**
- **After the output has been turned off, the internal discharge circuit goes into operation and discharges the output voltage. During testing and before this discharge completes, do not disconnect the tester from the DUT.**

During DC withstanding voltage tests and insulation resistance tests, the DUT, test leads, test probes, and the area around the output terminals are all charged to a high voltage. After the output has been turned off, be sure to check the following before you touch the items that have been charged to a high voltage, such as the withstanding voltage DUT, the test leads, the test probes, and the areas near the output terminals.

- **The TEST and DANGER LEDs are both off.**
- **The analog voltmeter is indicating "0."**

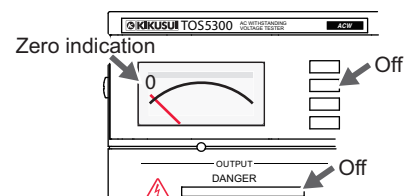

Discharge approximations

The time required to discharge the built-up electrical charge varies according to the test voltage and the properties of the DUT. When the TOS5300 Series is not connected to an DUT, the time that the tester requires to discharge the voltage from its internal capacitors down to 30 V is shown below.

	TOS5300	TOS5301	TOS5302
DC withstanding voltage test	—	Approx. 8 ms	—
Insulation resistance test (IR)	—	—	Approx. 1.3 ms

If the TOS5300 Series is connected to a 0.05 μF capacitor as an DUT, the time required to discharge the voltage down to 30 V is shown below.

	TOS5300	TOS5301	TOS5302
DC withstanding voltage test	—	Approx. 45 ms	—
Insulation resistance test (IR)	—	—	Approx. 7 ms

Interrupting Testing or Operations

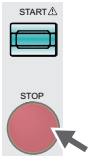

Before you change test conditions or other settings, press the STOP switch, and then be sure to check the following items to ensure safety. If you will not use the product for some time or if the operator will be away from the product, be sure to turn the POWER switch off.

- **The analog voltmeter is indicating "0."**
- **The TEST and DANGER LEDs are both off.**

Emergency Measures

There are two actions that you must carry out if, due to a malfunction in the product or the DUT, there is a possibility of an emergency occurring such as electric shock or damage to the DUT.

- **Turn the POWER switch off.**
- **Remove the power cord plug from the outlet.**

Turn the POWER switch off.

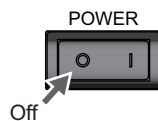

Remove the power cord

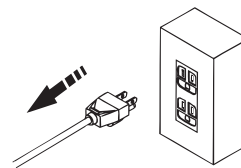

Forbidden Actions

Turning the power on and off repeatedly

After you turn the POWER switch off, wait for at least 10 seconds before you turn it back on. It is dangerous to do otherwise, because the protective features of the product may not work effectively. This may cause the product to malfunction, and it may reduce the life of the POWER switch and internal parts such as the fuses.

About Malfunctions



Possible electric shock.

- **Until you get the product fixed, make sure that nobody can use it.**
- **For repairs, contact your Kikusui agent or distributor.**

If the TOS5300 Series is in one of the states explained below, it may be malfunctioning in a very dangerous manner—it may not be possible to turn off the high voltage that is being generated. If the tester is not operating properly, it may be generating a high voltage irrespective of the settings made by the operator.

Immediately turn the POWER switch off, and disconnect the power cord from the outlet. Stop using the product immediately, and contact your Kikusui agent or distributor.

- **Even when you press the STOP switch, the DANGER LED remains lit.**
- **Even though a voltage is indicated on the voltmeter, the DANGER LED does not light.**

To Use the Product for a Long Time Free of Malfunctions

Taking size, weight, and cost into consideration, the heat dissipation capability of the voltage generator that is used for withstanding voltage tests has been designed to be one half that of the rated output. Use the TOS5300 Series within the following limits. If you use the product in a manner that exceeds these limits, the output section may overheat, and the internal protection circuits may be activated. If this happens, stop testing, and wait until the TOS5300 Series returns to its normal temperature.

■ Output limits during withstanding voltage tests

Ambient temperature	Upper limit	Pause time	Output time	
$t \leq 40\text{ }^{\circ}\text{C}$	AC	$50\text{ mA} < i \leq 110\text{ mA}$	Greater than or equal to the output time	30 minutes max.
		$i \leq 50\text{ mA}$	Not necessary	Continuous output possible
	DC	$5\text{ mA} < i \leq 11\text{ mA}$	Greater than or equal to the output time	1 minute max.
		$i \leq 5\text{ mA}$	Greater than or equal to the wait time (WAIT TIME)	Continuous output possible

(Output time = voltage rise time + test time + voltage fall time)



This page is intentionally blank.





4

Panel Operation Basics

This chapter describes how to select items on the screen and how to enter values.

Parts of the Screen

The screen that is used to set the basic test conditions is made up of the four parts shown below.

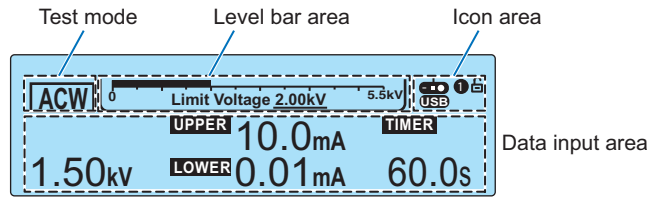

See p.86

To reset the TOS5300 Series to the factory default settings, hold down SHIFT, and turn the POWER switch on.

Test mode

This displays the currently selected test mode.

Display	Test mode
ACW	AC withstanding voltage test
DCW	DC withstanding voltage test
IR	Insulation resistance test
AUTO	Insulation resistance test → AC withstanding voltage test (IR→ACW) AC withstanding voltage test → insulation resistance test (ACW→IR)

Level bar area

This displays the selected test condition setting graphically.

Example: Setting the test voltage

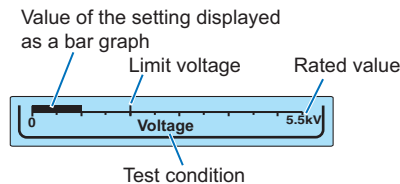

Example: Setting the limit voltage

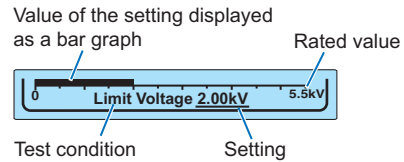



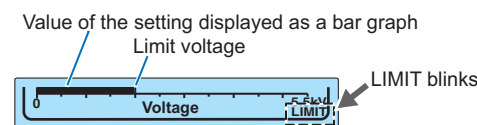

Example: Setting a voltage that is greater than or equal to the



Test condition	Display details
Voltage	The test voltage is displayed on a bar graph whose maximum value is the rated output voltage. The set limit voltage is indicated as a tick mark on the scale. If you try to set a test voltage that is greater than or equal to the limit voltage, "LIMIT" will blink in the level bar area, and you will not be able to set such a voltage.
Limit Voltage	The limit voltage is displayed as a value and on a bar graph whose maximum value is the rated output voltage.
Upper Current (ACW / DCW)	The upper current limit is displayed on a bar graph whose maximum value is the rated output current.
Lower Current (ACW / DCW)	The lower current limit is displayed on a bar graph whose maximum value is the rated output current.
Upper Resistance (IR)	The upper resistance limit is displayed on a bar graph whose maximum value is the maximum of the measurement range.
Lower Resistance (IR)	The lower resistance limit is displayed on a bar graph whose maximum value is the maximum of the measurement range.
Test Time	The test time is displayed on a bar graph whose maximum value is the maximum test time.

Icon area

The TOS5300 Series status is displayed using icons.

Icon	Status	See
	Key lock	<i>p.40</i>
	Remote control	—
	Model RC01-TOS/RC02-TOS remote control box connected	<i>p.16</i>
	Recalled memory number	<i>p.42</i>

Data input area

This area is used to enter the test voltage, limit voltage, upper and lower current limits, and test time.

The cursor (underscore) is displayed at the currently selected item.

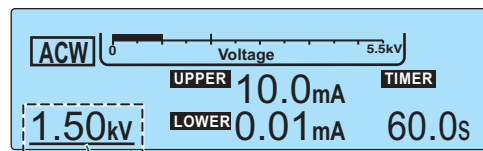

The underscore is displayed under the selected item.

Panel Operations

Switching between screens

The TOS5300 Series display is made up of a number of different screens. To return to the basic setup screen, press STOP.

To switch between the test mode screens, press FUNCTION. This will display the basic setup screen for the AC withstanding voltage, DC withstanding voltage, and insulation resistance (IR) tests. The display switches between screens each time you press FUNCTION.

★ Memo

The screen that first appears when you are setting test conditions is referred to as the basic setup screen.

★ Memo

The ACW key on the TOS5300, the ACW/DCW key on the TOS5301, and the ACW/IR/AUTO key on the TOS5302 are all referred to as the FUNCTION key.

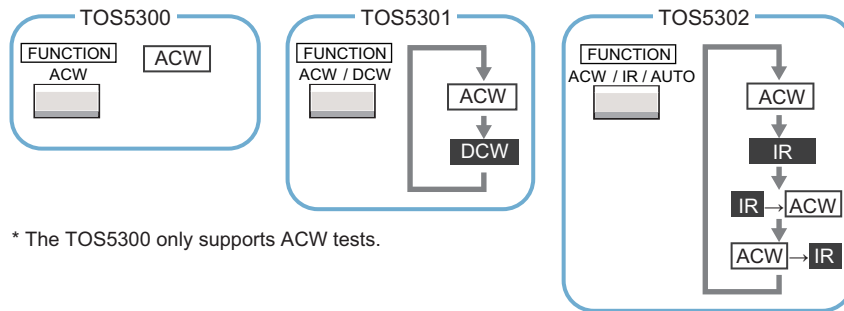

* The TOS5300 only supports ACW tests.

To display the memory recall screen, press MEMORY 1, MEMORY 2, or MEMORY 3. If you press SHIFT, this screen will switch to the store screen.

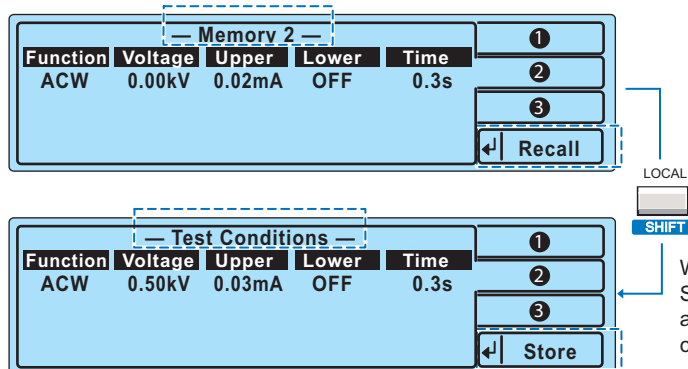

While you hold down SHIFT, the following key and the current test conditions are displayed.

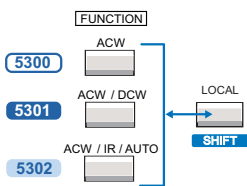

To display the configuration setup screen (Configuration Menu), press CONFIG (SHIFT+FUNCTION).

On the Configuration Menu, the Up, Down, and Select menu selection functions are assigned to the MEMORY keys.

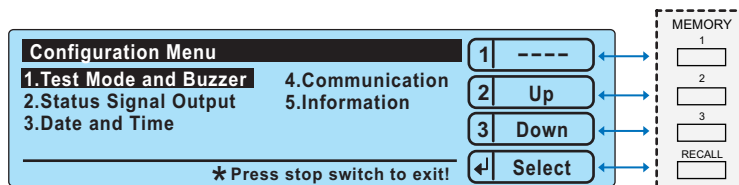

If you display a configuration item setup menu from the Configuration Menu, functions such as Menu, Up, Down, Check, and Apply are assigned to the MEMORY keys.

Selecting settings

To select a setting, use the SET, UPR/ LWR, or TEST key to move the underscore below the item that you want to select.

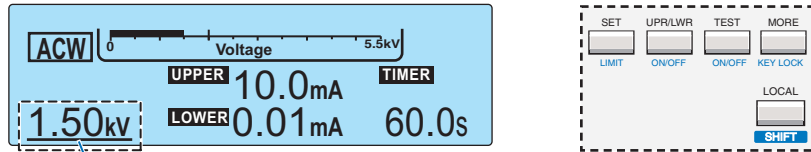

If you press SET, UPR/ LWR, or TEST on the basic setup screen, the corresponding setting is selected. (Example: Selecting the voltage)

If the setting that you want to select is not displayed, press MORE, or press SHIFT together with the corresponding key.

If you press MORE on the basic setup screen, you can display additional settings. (Example: Display a setting that is not displayed)

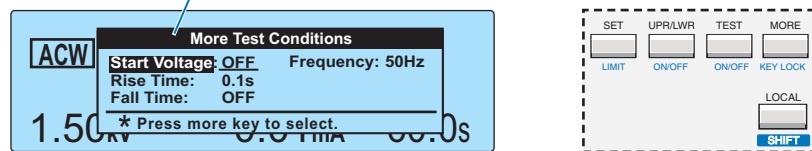

Hold down SHIFT and press SET to select the Limit Voltage setting. (Example: Selecting the limit voltage)

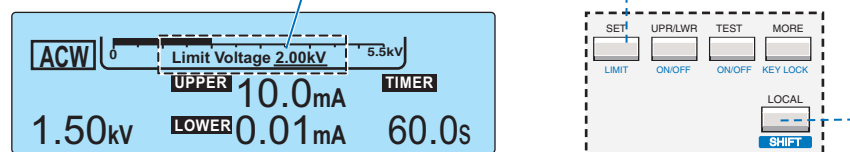

Entering values

You can turn the rotary knob to set the value of the selected setting.

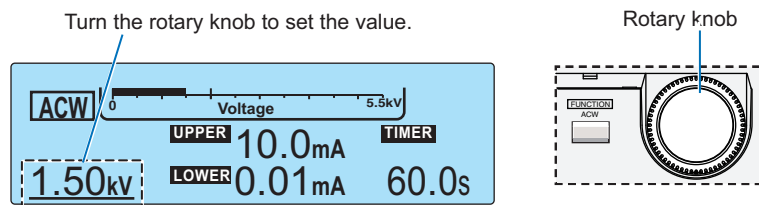

If you press SHIFT and turn the rotary knob, you can change the setting resolution. Depending on how much you turn the rotary knob, you can set the value, 2, 4, or 8 times as fast as when you do not press SHIFT.

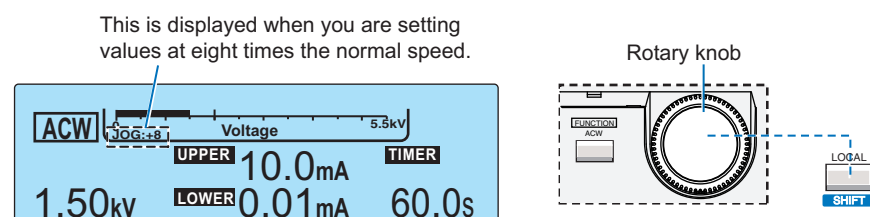



Locking panel operations (key lock)

The key lock feature can be used to prevent changes to the test conditions due to incorrect operations.

To lock the panel operations, press KEY LOCK (SHIFT+MORE).

In this state, only the START and STOP switches are enabled.

When keys are locked, the key lock icon () appears on the screen. If you try to use a locked key, the key lock icon () blinks for approximately 2 seconds.

To release the key lock, hold down KEY LOCK (SHIFT+MORE) until the key lock icon () disappears.

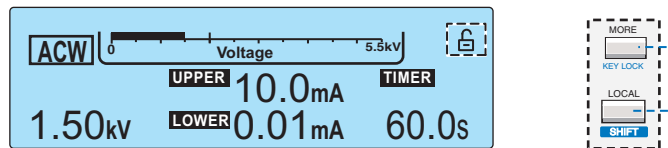

See p.22

If you will run tests using conditions that you have recalled from memory, we recommend that you use the protection cover.

Selecting the Test Mode

Single test (ACW, DCW, or IR)

The TOS5300 Series has three single test modes. Depending on the model, the test modes that you can select differ.

Performing a test in any of the following modes is referred to as a single test.

- AC withstanding voltage test mode (ACW)
- DC withstanding voltage test mode (DCW) **5301**
- Insulation resistance test (IR) **5302**

Press FUNCTION to select the test mode.

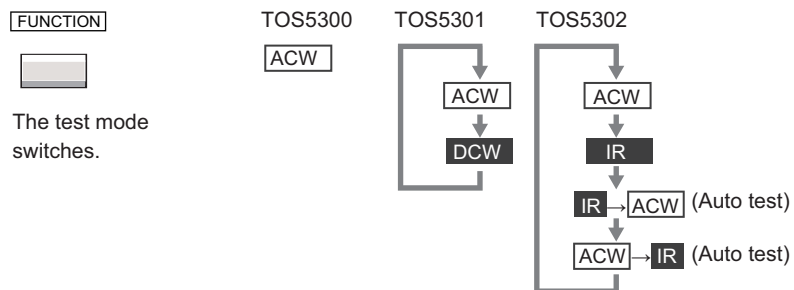

Auto test (AUTO TEST) **5302**

See p.50

You can also perform auto tests (AUTO TEST), in which an AC withstanding voltage test and an insulation resistance test (IR) are performed consecutively.

To perform auto tests (AUTO), press FUNCTION to select the consecutive tests that you want to perform. For details, see "Auto Test (AUTO TEST)."

Panel Memory

You can save up to three sets of test conditions (the test conditions currently being used) to internal memory.

On the TOS5302, you can save two sets of test conditions with each set containing a combination of an ACW test and an IR test (for auto tests).

Test conditions that can be saved

Setting		TOS5300	TOS5301	TOS5302
Test mode		ACW	ACW, DCW	ACW, IR ACW→IR, IR→ACW
ACW	Test voltage	Yes	Yes	Yes
	Limit voltage	Yes	Yes	Yes
	Output frequency	Yes	Yes	Yes
	Upper limit	Yes	Yes	Yes
	Lower limit	Yes	Yes	Yes
	Test time	Yes	Yes	Yes
	Voltage rise time	Yes	Yes	Yes
	Voltage fall time	Yes	Yes	Yes
	Start voltage	Yes	Yes	Yes
DCW	Test voltage	No	Yes	No
	Limit voltage	No	Yes	No
	Upper limit	No	Yes	No
	Lower limit	No	Yes	No
	Test time	No	Yes	No
	Voltage rise time	No	Yes	No
	Start voltage	No	Yes	No
	Judgment wait time	No	Yes	No
IR	Test voltage	No	No	Yes
	Limit voltage	No	No	No
	Upper limit	No	No	Yes
	Lower limit	No	No	Yes
	Test time	No	No	Yes
	Judgment wait time	No	No	Yes
	Current detection response speed	No	No	Yes

■ Test condition settings

	ACW	DCW	IR
Test voltage	0.00 kV to 5.50 kV	0.00 kV to 6.20 kV	25 V / 50 V / 100 V / 125 V / 250 V / 500 V / 1000 V
Limit voltage	0.00 kV to 5.50 kV	0.00 kV to 6.20 kV	—
Output frequency	50 Hz / 60 Hz	—	—
Upper limit	0.01 mA to 110 mA	0.01 mA to 11 mA	OFF / 30kΩ to 5.00 GΩ
Lower limit	OFF / 0.01 mA to 110 mA	OFF / 0.01 mA to 11 mA	OFF / 30kΩ to 5.00 GΩ
Test time	OFF / 0.1 s to 999 s	OFF / 0.1 s to 999 s	OFF / 0.1 s to 999 s
Voltage rise time	0.1 s to 10.0 s	0.1 s to 10.0 s	—
Voltage fall time	OFF / 0.1 s	—	—
Start voltage	OFF / 50 %	OFF / 50 %	—
Judgment wait time	—	0.1 s to 10.0 s	0.1 s to 10.0 s
Current detection response speed	—	—	Fast / Mid / Slow

— Memory 2 —					1
Function	Voltage	Upper	Lower	Time	2
ACW	0.00kV	0.02mA	OFF	0.3s	3
IR	0.10kV	OFF	OFF	0.3s	Recall

Initial panel memory settings

Initially, memory numbers 1 to 3 contain AC withstanding voltage test conditions. Feel free to use these test conditions if they match the tests that you want to perform.

For details on the test conditions that are initially contained in memory, see “Default panel memory values.”

See p.87

Saving test conditions

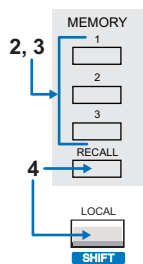

1 Display the basic setup screen, and then set the test conditions.

2 Press MEMORY 1, MEMORY 2, or MEMORY 3.

The memory screen appears. The contents of the selected memory number are displayed.

— Memory 2 —					1
Function	Voltage	Upper	Lower	Time	2
ACW	0.00kV	0.02mA	OFF	0.3s	3
IR	0.10kV	OFF	OFF	0.3s	Recall

3 Press MEMORY 1, MEMORY 2, or MEMORY 3 to select the memory number (1 to 3) in which you want to save the current test conditions.

4 Press SHIFT+RECALL to display the current test conditions and store the conditions in the selected memory number.

The displayed screen switches from the Recall screen to the Store screen, and the test conditions are saved.

Displays the test conditions that you set on the basic setup screen

— Test Conditions —					1
Function	Voltage	Upper	Lower	Time	2
ACW	0.00kV	0.02mA	OFF	0.3s	3
IR	0.10kV	OFF	OFF	0.3s	Store

After the test conditions have been saved, the basic setup screen is displayed.

Recalling test conditions

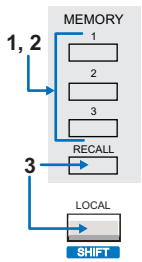

1 Press MEMORY 1, MEMORY 2, or MEMORY 3.

The memory screen appears. The contents of the selected memory number are displayed.

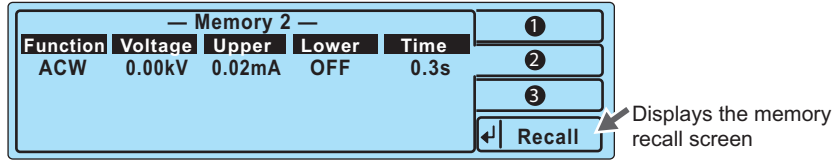

2 Press MEMORY 1, MEMORY 2, or MEMORY 3 to specify the memory number (1 to 3) from which you want to recall test conditions.

The test conditions that are saved in the memory number (1 to 3) that you specified are displayed.

3 Press RECALL to recall the test conditions that are saved in the specified memory number.

The basic setup screen is displayed, and the icon corresponding to the memory number is displayed in the icon area. The TOS5300 Series is now set to the recalled test conditions.

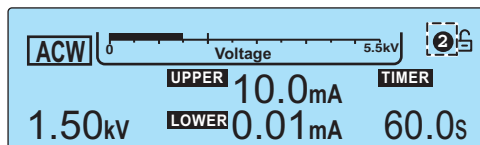

Example: The test conditions that were saved in MEMORY 2 have been recalled.

If you change the recalled test conditions, the memory number disappears. Even if you set the test conditions back to the values that are stored in memory, the memory number will not reappear.



5

Withstanding Voltage and Insulation Resistance Tests

This chapter explains withstanding voltage and insulation resistance tests, from how to set the test conditions to how to save test results.

About Judgment

The TOS5300 Series judges whether a test results in PASS, L-FAIL, or U-FAIL on the basis of the limits that are set in advance.

- PASS When the test time elapses (TIMER is 0 seconds), if the condition “lower limit < measured value < upper limit” is true, a PASS judgment is made, and the test ends.
- L-FAIL If the condition “lower limit ≥ measured value” is true, a LOWER FAIL judgment is made, and the test is immediately stopped.
- U-FAIL If the condition “upper limit ≤ measured value” is true, an UPPER FAIL judgment is made, and the test is immediately stopped.

Effectiveness of the upper and lower limits

Normally, even a good DUT will have a certain degree of leakage current. Setting the upper limits just within the boundaries of the characteristic range of the DUT is useful in detecting breaks in the test leads and poor connections, enabling you to perform highly reliable testing.

You can perform tests effectively by enabling the lower limit (turning LOWER on) in withstanding voltage tests and the upper limit (turning UPPER on) in insulation resistance tests.

Invalid Settings

If you specify an invalid value for a setting, a message blinks in the level bar area. While a message is displayed here, the READY LED turns off, and you cannot start testing. You also cannot select other items.

Specify a valid value.

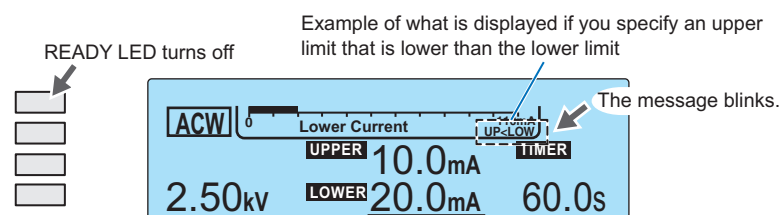

Message	Description
UP < LOW	When the lower or upper limit is turned on, and the upper limit has been set lower than the lower limit.
OVER VOLT	When the limit voltage has been set lower than the set test voltage.
OVER WAIT	When the timer is on and the judgment wait time has been set to a value that is greater than or equal to the total of the voltage rise time and the test time.
OVER 550 VA	When the test voltage and the upper limit are set in the AC withstanding voltage test settings such that their product exceeds 550 VA.
OVER 55 W	When the test voltage and the upper limit are set in the DC withstanding voltage test settings such that their product exceeds 55 W.
OVER 1.1 mA	When the test voltage is set in the insulation resistance test settings such that when divided by the lower limit, the quotient exceeds 1.1 mA.

Setting Withstanding Voltage Test Conditions

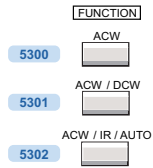

Press FUNCTION to display the AC or DC withstanding voltage test setup screen.

See p.35

For details on how to select settings and enter values, see "Panel Operation Basics."

See p.26

For details on how to connect the TOS5300 Series to the DUT, see "Connecting to the Device under Test (DUT)."

See p.46, p.51

For details on the LOWER and UPPER settings, see "About Judgment." For details on other test conditions, see "Setting Other Test Conditions."

AC withstanding voltage test (ACW) settings

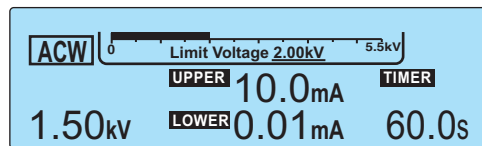

Item	Description	Panel operation
Voltage	Sets the test voltage. You cannot specify a voltage that is greater than or equal to the limit voltage.	SET key
	0.00 kV to 5.50 kV Setting	Rotary knob
Limit Voltage	Sets the limit voltage. This prevents an unnecessarily high voltage from being applied to the DUT because of incorrect operations of the TOS5300 Series.	LIMIT (SHIFT+SET) key
	0.00 kV to 5.50 kV Setting	Rotary knob
UPPER	Sets the upper limit that is used in judgments. If a current that is greater than or equal to the upper limit is measured, a U-FAIL judgment occurs.	UPR/ LWR key
	0.01 mA to 110 mA Setting	Rotary knob
LOWER	Sets the lower limit that is used in judgments. While LOWER is on, if a current that is less than or equal to the lower limit is measured, an L-FAIL judgment occurs.	UPR/ LWR key
	0.01 mA to 110 mA Setting	Rotary knob
	OFF The lower limit is not used in judgments.	ON/ OFF (SHIFT+UPR/ LWR) key
TIMER	Sets the test time. The test time begins when the voltage rise time elapses. The test time begins when the voltage rise time elapses.	TEST key
	0.1 s to 999 s When the specified time elapses, the test ends.	Rotary knob
	OFF The set test time is ignored. A PASS judgment is not performed. Press STOP to stop testing.	ON/ OFF (SHIFT+TEST) key
Start Voltage	Sets the start voltage to 50 % of the test voltage.	MORE key
	50 % The start voltage is set to 50 % of the test voltage.	Rotary knob
	OFF The start voltage is not set.	
Rise Time	Sets the voltage rise time.	MORE key
	0.1 s to 10.0 s Setting	Rotary knob

Item	Description	Panel operation
Fall Time	Sets the voltage fall time. This setting is only used when a PASS judgment occurs.	MORE key
	0.1 s The output voltage falls approximately 0.1 seconds after a test ends with a PASS judgment.	Rotary knob
	OFF The output voltage is shut off immediately after a test ends with a PASS judgment.	
Frequency	Sets the test voltage frequency.	MORE key
	50 Hz, 60 Hz Setting	Rotary knob

DC withstanding voltage test (DCW) settings

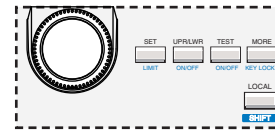
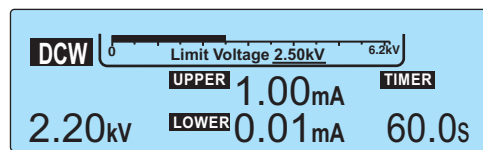

Item	Description	Panel operation
Voltage	Sets the test voltage. You cannot specify a voltage that is greater than or equal to the limit voltage.	SET key
	0.00 kV to 6.20 kV Setting	Rotary knob
Limit Voltage	Sets the limit voltage. This prevents an unnecessarily high voltage from being applied to the DUT because of incorrect operations of the TOS5300 Series.	LIMIT (SHIFT+SET) key
	0.00 kV to 6.20 kV Setting	Rotary knob
UPPER	Sets the upper limit that is used in judgments. If a current that is greater than or equal to the upper limit is measured, a U-FAIL judgment occurs.	UPR/ LWR key
	0.01 mA to 11 mA Setting	Rotary knob
LOWER	Sets the lower limit that is used in judgments. While LOWER is on, if a current that is less than or equal to the lower limit is measured, an L-FAIL judgment occurs.	UPR/ LWR key
	0.01 mA to 11 mA Setting	Rotary knob
	OFF The lower limit is not used in judgments.	ON/ OFF (SHIFT+UPR/ LWR) key
TIMER	Sets the test time. The test time begins when the voltage rise time elapses. The test time begins when the voltage rise time elapses.	TEST key
	0.1 s to 999 s When the specified time elapses, the test ends.	Rotary knob
	OFF The set test time is ignored. A PASS judgment is not performed. Press STOP to stop testing.	ON/ OFF (SHIFT+TEST) key
Start Voltage	Sets the start voltage to 50 % of the test voltage.	MORE key
	50 % The start voltage is set to 50 % of the test voltage.	Rotary knob
	OFF The start voltage is not set.	
Rise Time	Sets the voltage rise time.	MORE key
	0.1 s to 10.0 s Setting	Rotary knob
Wait Time	Sets the judgment wait time, which is the time that the TOS5300 Series waits before actually starting judgment after START is pressed. This prevents mistaken judgments during the voltage rise time.	MORE key
	0.1 s to 10.0 s Setting	Rotary knob

Setting Insulation Resistance Test Conditions

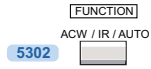

Press FUNCTION to display the insulation resistance (IR) test setup screen.

See p.35

For details on how to select settings and enter values, see "Panel Operation Basics."

See p.46, p.51

For details on the LOWER and UPPER settings, see "About Judgment." For details on other test conditions, see "Setting Other Test Conditions."

Insulation resistance test (IR) settings

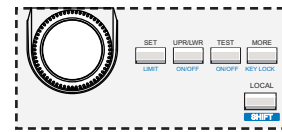
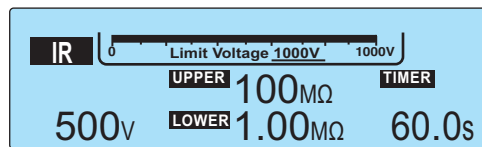

Item	Description	Panel operation
Voltage	Sets the test voltage. You cannot specify a voltage that is greater than or equal to the limit voltage.	SET key
	25 V, 50 V, 100 V, 125 V, 250 V, 500 V, 1000 V Setting	Rotary knob
Limit Voltage	Sets the limit voltage. This prevents an unnecessarily high voltage from being applied to the DUT because of incorrect operations of the TOS5300 Series.	LIMIT (SHIFT+SET) key
	25 V, 50 V, 100 V, 125 V, 250 V, 500 V, 1000 V Setting	Rotary knob
UPPER	Sets the upper limit that is used in judgments. While UPPER is on, if a resistance that is greater than or equal to the upper limit is measured, a U-FAIL judgment occurs.	UPR/ LWR key
	0.03 MΩ to 5.00 GΩ Setting	Rotary knob
	OFF The upper limit is not used in judgments.	ON/ OFF (SHIFT+UPR/ LWR) key
LOWER	Sets the lower limit that is used in judgments. While LOWER is on, if a resistance that is less than or equal to the lower limit is measured, an L-FAIL judgment occurs.	UPR/ LWR key
	0.03 MΩ to 5.00 GΩ Setting	Rotary knob
	OFF The lower limit is not used in judgments. This can only be set when the upper limit is not used in judgments (when UPPER is off).	Press and hold the ON/ OFF (SHIFT+UPR/ LWR) key ¹
TIMER	Sets the test time. The test time begins when the voltage rise time elapses.	TEST key
	0.1 s to 999 s When the specified time elapses, the test ends.	Rotary knob
	OFF The set test time is ignored. A PASS judgment is not performed. Press STOP to stop testing.	ON/ OFF (SHIFT+TEST) key
Response	Sets the current detection response speed that is used in U-FAIL judgment.	MORE key
	Fast, Mid, Slow Setting	Rotary knob
Wait Time	Sets the judgment wait time, which is the time that the TOS5300 Series waits before actually starting judgment after START is pressed. This prevents mistaken judgments during the voltage rise time.	MORE key
	0.1 s to 10.0 s Setting	Rotary knob

1 To select the value for the LOWER setting, hold down ON/ OFF (SHIFT+UPR/ LWR) for at least 3 seconds.

Auto Test (AUTO TEST)

5302

An auto test (AUTO) is a series of tests that contains an AC withstanding voltage test and an insulation resistance test (IR) that are performed automatically.

There are the following two types of auto tests.

■ Insulation resistance test (IR) → AC withstanding voltage test (ACW)

AUTO FUNC	VOLTAGE	UPPER	LOWER	TIMER
IR	25V	OFF	OFF	0.3s
ACW	1.50kV	10.0mA	OFF	60.0s

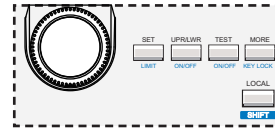

■ AC withstanding voltage test (ACW) → insulation resistance test (IR)

AUTO FUNC	VOLTAGE	UPPER	LOWER	TIMER
ACW	1.50kV	0.02mA	OFF	60.0s
IR	25V	OFF	OFF	0.3s

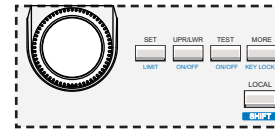

Press FUNCTION to display the auto test (IR→ACW or ACW→IR) setup screen.

FUNCTION

ACW / IR / AUTO

5302



See p.35 , p.51

For details on how to select settings and enter values, see "Panel Operation Basics." For details on other test conditions, see "Setting Other Test Conditions."

See p.47 , p.49

You cannot set test conditions on the auto test screen. Set AC withstanding voltage test conditions on the ACW setup screen and insulation resistance test conditions on the IR setup screen.

Setting Other Test Conditions

See p.47, p.48
p.49



You can set the following items on the More Test Conditions setup screen.

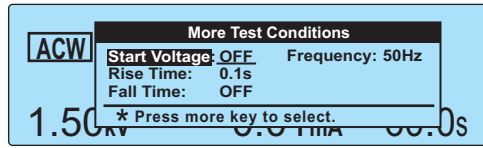

Example: Selecting the value of the

- Start voltage
- Voltage rise time
- Voltage fall time
- Frequency
- Current detection response speed
- Judgment wait time

1 Press MORE to display the More Test Conditions setup screen.

The items that are displayed vary depending on your TOS5300 Series model.

2 Press MORE to move the cursor to the test condition that you want to set, and then use the rotary knob to set its value.

Press STOP to exit the More Test Conditions setup screen.
Return to the basic setup screen.

★ Memo

Press MORE to move between the settings on the More Test Conditions screen. Each time that you press MORE, the cursor moves to the next setting. After selecting a setting, use the rotary knob to set its value.

Start voltage

Separate from the test voltage, you can set the voltage that AC and DC withstanding voltage tests begin at. You can set the start voltage to 50 % of the test voltage. The output voltage reaches this value approximately 0.1 seconds after the start of testing.

50 %	The start voltage is set to 50 % of the test voltage.
OFF	The start voltage is not set.

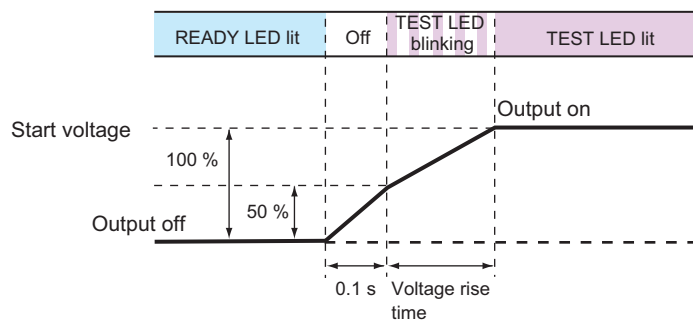

Voltage rise time

Separate from the test time, you can set the time that the TOS5300 Series takes to raise the voltage to the test voltage during AC and DC withstanding voltage tests.

Time	0.1 s to 10.0 s
------	-----------------

Voltage fall time

Separate from the test time, you can set the time that the TOS5300 Series takes to lower the voltage after an AC withstanding voltage test ends. This setting is only used when a PASS judgment occurs.

0.1 s	The output voltage falls over approximately 0.1 seconds after a test ends with a PASS judgment.
OFF	The output voltage falls immediately after a test ends with a PASS judgment.

Frequency

You can set the frequency of the test voltage of AC withstanding voltage tests.

50 Hz	The test voltage frequency is set to 50 Hz.
60 Hz	The test voltage frequency is set to 60 Hz.

Current detection response speed 5302

You can select the current detection response speed when a value less than or equal to the lower limit is measured during insulation resistance (IR) tests. You can select from Fast, Mid, and Slow.

Fast	Use this setting when the test time is short or when you want to reduce takt time. This setting makes the TOS5300 Series more susceptible to external noise. Set the test time (Test Time) to 0.1 seconds or more.
Mid	Use this setting for normal tests. Set the test time (Test Time) to 0.3 seconds or more.
Slow	Use this setting when the Fast or Mid setting, which makes the TOS5300 Series susceptible to external noise, produces highly inconsistent measured values. Set the test time (Test Time) to 0.5 seconds or more.

Judgment wait time (Wait Time) 5301 5302

You can set the time between when a DC withstanding voltage or insulation resistance (IR) test starts (when you press START) and when judgment actually begins.

During a DC withstanding voltage test or an insulation resistance test, when the test voltage is applied to an DUT with a capacitive component, a large charge current may flow until charging is completed, or the insulation resistance may be measured at a value lower than its actual value because of the charge current. By setting a judgment wait time, you can prevent incorrect judgments caused by breaches to the upper or lower limits that occur because of the effect of the charge current that flows to the capacitive load during the voltage rise time.

Judgment wait time	0.1 s to 10.0 s
--------------------	-----------------

- **Operation during a DC withstanding voltage test (example in which the test voltage is reached over the specified voltage rise time)**

When the voltage rise time elapses, the LOWER judgment begins. When the judgment wait time elapses, the UPPER judgment begins.

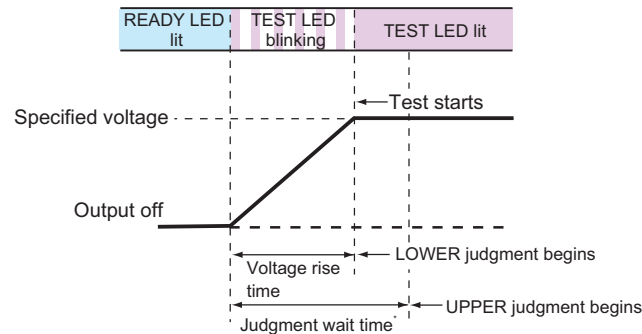

* As a guideline, this is "voltage rise time + approximately 0.1 s."

- **Operation during an insulation resistance (IR) test (example in which the test voltage is reached over the normal voltage rise time)**

When the voltage rise time elapses, the UPPER judgment begins. When the judgment wait time elapses, the LOWER judgment begins.

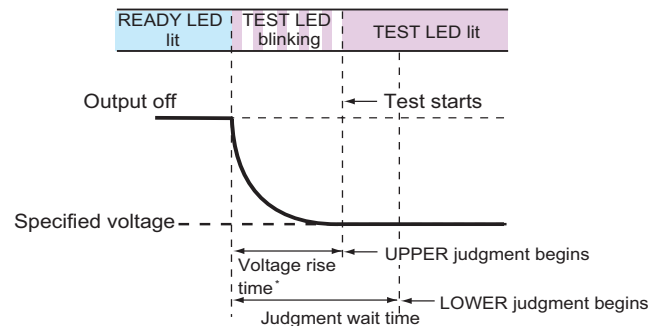

* The voltage rise time is approximately 50 ms.

Selecting Measurement Method

you can select the voltage and current measurement method to use in AC withstanding voltage tests.

There are the following two types of measurement methods.

- True rms response (RMS)
- Mean-value response (AVE)

NOTE

The method used in Kikusui's TOS9200 series, TOS8870A, TOS8850, TOS8850A, TOS5000 series, and TOS5000A series is mean-value response.

You can use the configuration setup screen (Configuration Menu) to set the method.

1 Press CONFIG (SHIFT+FUNCTION) to display the configuration setup screen (Configuration Menu).

2 Hold down MORE for approximately 2 seconds.

The Advanced Menu appears.

MORE

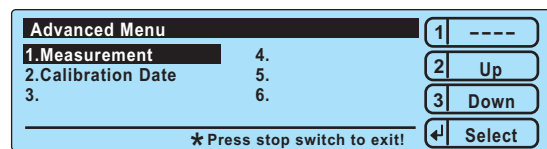

3 Press 2: Up (MEMORY 2) or 3: Down (MEMORY 3) to move the cursor to 1.Measurement, and press Select (←: RECALL) to select it.

4 Use the rotary knob to select the measurement method.

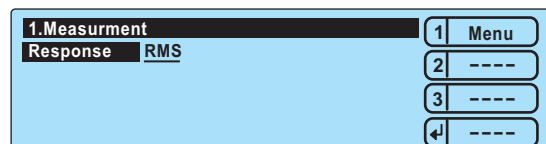

★ Memo

If you select mean-value response (AVE), when you return to the basic screen, the **AVE** icon will appear at the upper right of the screen.

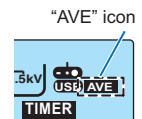

RMS	True rms response
AVE	Mean-value response

To leave the measurement method setup screen and return to the Advanced Menu, press 1: Menu (MEMORY 1). To leave the Advanced Menu and return to the basic setup screen, press STOP.

Saving the Calibration Date

See p.73

Whenever you calibrate the TOS5300, save the calibration date. If the calibration expiration date based on this date is reached, an expiration message will appear. You can access the calibration date from the configuration setup screen (Configuration Menu).

1 Press CONFIG (SHIFT+FUNCTION) to display the configuration setup screen (Configuration Menu).

2 Hold down MORE for approximately 2 seconds.

The Advanced Menu appears.

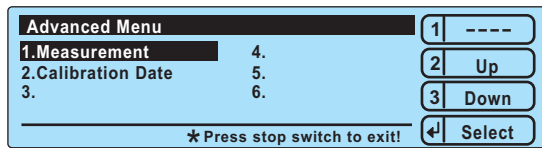

3 Press 2: Up (MEMORY 2) or 3: Down (MEMORY 3) to move the cursor to 2.Calibration Date, and press Select (←: RECALL) to select it.

4 Press 2: Up (MEMORY 2) or 3: Down (MEMORY 3) to select the year, month, or day that you want to set, and then use the rotary knob to set the value.

Memo
Press Today (RECALL) to set today's date.

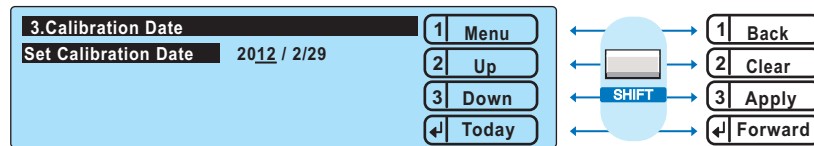

When the calibration date setup screen is displayed, pressing SHIFT changes the functions of the keys.

1 Back	SHIFT + 1: Back	Displays the previous setup screen.
2 Clear	SHIFT + 2: Clear	Returns to date that was set during the last calibration service.
3 Apply	SHIFT + 3: Apply	Applies the set calibration date.
← Forward	SHIFT + ←: Forward	Displays the next setup screen.

5 Press 3: Apply (SHIFT+MEMORY 3) to update the calibration date.

To leave the calibration date setup screen and return to the Advanced Menu, press 1: Menu (MEMORY 1). To leave the Advanced Menu and return to the basic setup screen, press STOP.

Setting Other Test Features

See p.88

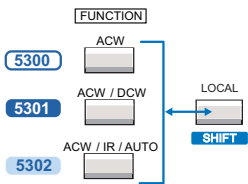

You can use the configuration setup screen (Configuration Menu) to set the following settings.

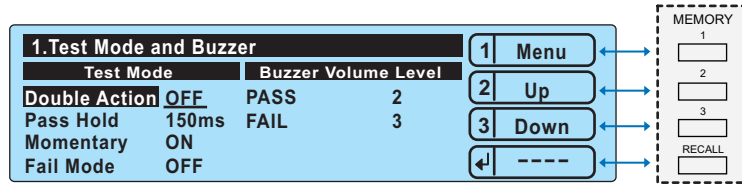

Example: Selecting the value of the Double Action setting on the 1. Test Mode and Buzzer

- Double action feature
- Length of time to maintain a PASS judgment result
- Momentary feature
- Fail mode
- Buzzer volume

- 1 Press **CONFIG (SHIFT+FUNCTION)** to display the configuration setup screen (Configuration Menu), and then select **1. Test mode and Buzzer**.
- 2 Press **2: Up (MEMORY 2)** or **3: Down (MEMORY 3)** to select the setting that you want to set, and then use the rotary knob to set the value.

Double action feature

This feature enables you to start a test by first pressing STOP and then pressing START within 0.5 seconds. If you do not press START within this time limit, the test does not start (the READY LED turns off). This feature ensures that tests are started safely because it requires you to use both the STOP and START switches.

ON	The double action feature is turned on.
OFF	The double action feature is turned off.

Length of time to maintain a PASS judgment result

This feature enables you to set the length of time that the TOS5300 Series maintains a PASS judgment state. If you set Pass Hold to HOLD, the measured results remain displayed on the screen until you press STOP. When a FAIL judgment occurs, the FAIL judgment's measured results remain displayed on the screen until you press STOP, regardless of the value of the Pass Hold setting.

Time	50 ms, 100 ms, 200 ms, 1 s, 2 s, 5 s
HOLD	The PASS judgment state is maintained until STOP is pressed.

Momentary feature

This feature enables you to perform tests only while you are pressing START. This ensures safe testing because it means that your hand must be fixed to the panel or to an optional START switch.

Using this feature with the optional RC02-TOS (two-hand-type remote control box [See](#) p.16) provides an even higher level of safety.

While this feature is on, testing stops as soon as you release START. The stop operation is the same as if you had pressed STOP.

ON	The momentary feature is turned on.
OFF	The momentary feature is turned off.

Fail mode feature

This feature enables you to prevent remotely transmitted stop signals from clearing FAIL judgments and protection modes.

If you are using the optional high voltage test probe (model HP01A-TOS/HP02A-TOS [See](#) p.17), turn fail mode on. When a test ends with a FAIL judgment, the FAIL judgment is not cleared even if you let go of the probe. To clear the FAIL judgment, press STOP on the front panel.

ON	The fail mode feature is turned on.
OFF	The fail mode feature is turned off.

Buzzer volume

You can set the volume level of the buzzer that is sounded when PASS and FAIL judgments occur. When a PASS judgment occurs, the buzzer sounds for approximately 50 ms, regardless of the value of the Pass Hold setting. When a FAIL judgment occurs, the buzzer sounds until you press STOP.

PASS judgment setting range	0 to 10
FAIL judgment setting range	0 to 10

Starting Testing



Possible electric shock. During testing, do not touch the test leads and the DUT.

To start testing

- 1 Check that the TOS5300 Series is correctly connected to the DUT.
- 2 When the READY LED lights in light blue, press START.

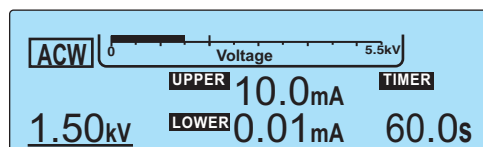

See p.60

If the test does not start, see "If you cannot start testing."

See p.78

If you want to start another test after testing finishes, set a wait time between tests as necessary.

When testing starts

The TEST and DANGER LEDs light. The TEST LED lights in red.

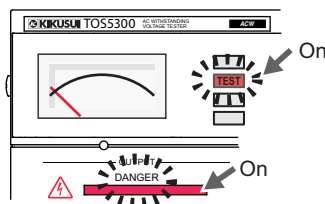

The TEST and DANGER LEDs light. The TEST LED lights in red.

If the start voltage and the voltage rise time have been set

See p.47, p.48, p.51

After the voltage rises to the start voltage or after the voltage rise time elapses, the TEST LED lights in red, and the test starts. While the voltage is rising, the TEST LED blinks in red, and the display counts up to the set rise time.

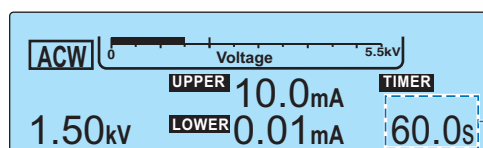

Counts up the voltage rise time

If the start voltage has been turned off and the voltage rise time has not been set

After 0.1 seconds, the TEST LED lights in red, and the test starts.

If the test time has been set or if the test time has been turned off

See p.47 , p.48

The TEST LED lights in red during testing. If the test time has been turned on, the display counts down from the set test time. If the test time has been turned off, the display counts up to represent the elapsed test time.

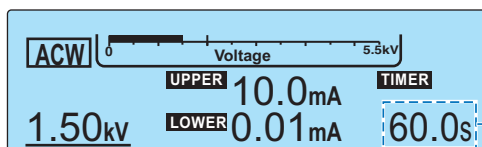

The time display after you start testing differs depending on whether TIMER is set to ON or OFF.

TIMER ON	The timer's remaining test time is counted down.
TIMER OFF	The elapsed test time is counted up. When the test time exceeds 999 seconds, "999" blinks.

If the judgment wait time has been set 5301 5302

See p.53

The TEST LED lights in red and the test starts, but judgment doesn't begin until the judgment wait time elapses.

To change the voltage setting during testing

While the TEST LED is lit in red, press SET to select the voltage setting, and then use the rotary knob to change the value. The voltage is changed immediately.

The changed voltage is immediately applied to the test, but the voltage value on the display shows the measured value. After the test finishes, when the TOS5300 Series returns to the READY state, the new voltage value is shown on the display.

If you cannot start testing

In the following situations, you will not be able to start testing, and the READY LED will not light.

See p.42

- **If the memory number is not fixed while panel settings are being recalled from or saved to memory.**

See p.64

- **If STOP is being pressed (including when a STOP signal is being applied to the SIGNAL I/O connector).**

See p.46

- **If a message is displayed in the level bar area.**

A message blinks in the level bar area when an invalid setting has been made. In this situation, you cannot start testing. Specify a valid value.

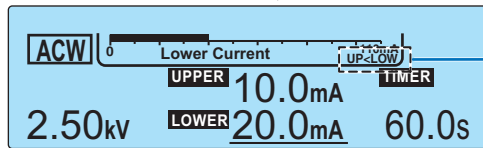

A message that indicates the invalid setting blinks here.

- **If PASS or FAIL is displayed.**

You cannot start testing while a judgment result is displayed. Press STOP to switch the TOS5300 Series to the READY state.

- **If a PROTECTION message is displayed.**

If a PROTECTION message is displayed, the TOS5300 Series has switched to protection mode and will not allow you to start testing. Remove the cause of the problem.

See p.93

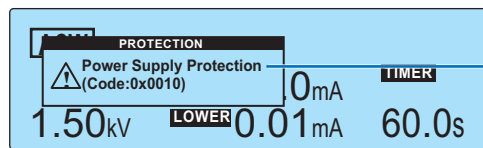

The cause that activated the protection feature and the code number are displayed.

- **If the double action feature has been turned on.**

When the double action feature is turned on, you cannot start tests just by pressing START. Press STOP, and then press START within 0.5 seconds.

See p.56

Stopping Testing

To stop testing



Press STOP.

When testing finishes

A test will stop under one of the following conditions.

- a. If the test time elapses (when TIMER is set to ON).
- b. If a current greater than or equal to the upper limit (U-FAIL) or less than or equal to the lower limit (L-FAIL) is measured.
- c. If you press STOP.

After a test finishes, the DANGER LED turns off, and the high voltage output is turned off.

If the test finished under condition a or b given above, the judgment result will be displayed on the screen.

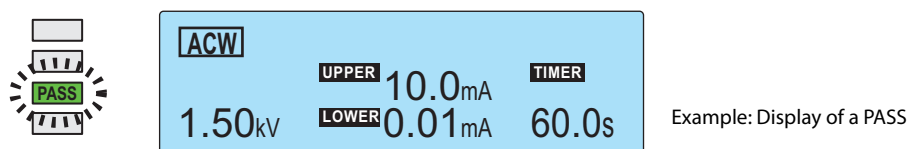

If the test time has been set

See p.47 , p.48

After the test time elapses, the PASS LED lights in green, and the test finishes. The PASS LED remains lit in green for the length of time specified by Pass Hold. The READY LED then lights in light blue, and the TOS5300 Series switches to the READY state.

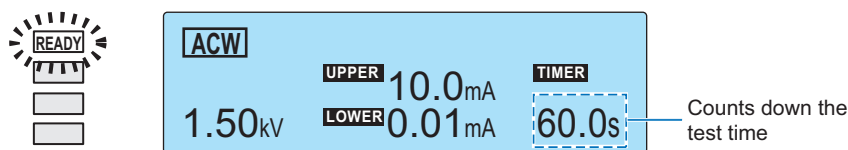

See p.46

For details on how measured values are judged, see "About Judgment."

The operations that the TOS5300 Series performs after testing finishes for each judgment condition are shown below.

Operation	PASS	U-FAIL	L-FAIL
Display	PASS LED lights in green. Measured value remains displayed for the length of time specified by Pass Hold.	The FAIL LED lights in yellow. "OVER" and the UPPER setting are displayed on the screen.	The FAIL LED lights in yellow. "UNDER" and the LOWER setting are displayed on the screen.
Buzzer	Sounds for 50 ms. ¹	Sounds until STOP is pressed.	
SIGNAL I/O connector	The PASS signal is generated for the length of time specified by the Pass Hold setting.	The U-FAIL signal is generated until the FAIL judgment is cleared.	The L-FAIL signal is generated until the FAIL judgment is cleared.

¹ The length of time that the buzzer sounds when a PASS judgment occurs is fixed to 50 ms. The specified Pass Hold time has no effect.

To clear judgment results

Press STOP to switch the TOS5300 Series to the READY state (the READY LED lights).



This page is intentionally blank.





6

External Control

This chapter explains how to use the SIGNAL I/O connector to externally start tests and recall panel memory entries and sequence programs.

SIGNAL I/O Connector



WARNING Possible electric shock. Ensure that all devices are off before you connect or disconnect cables between them.



CAUTION Possible damage to the internal circuitry.

- Keep the signal wire at least 500 mm away from the high-voltage test lead and the DUT.
- Do not short the output voltage circuit.
- If you use the TOS5300 Series with incomplete connections, burn outs caused by heating may occur when the output is turned on.
- Do not touch the contacts or attach insulators to them. Doing so may reduce the quality of the contacts or cause other problems.
- Do not short the +24 V of pin 24 to the chassis or the circuit common.

The SIGNAL I/O connector is the D-sub 25-pin connector on the rear panel.

This connector is used to start and stop tests, recall panel memory entries and test modes, and monitor the status of the TOS5300 Series.

- Connector on the rear panel
XM3B-2522 D-sub 25-pin female connector (socket) ;
manufactured by OMRON Corporation, Screw M2.6 x 0.45
- Complies connector (plug)
D-sub 25-pin male (with fix screw M2.6)

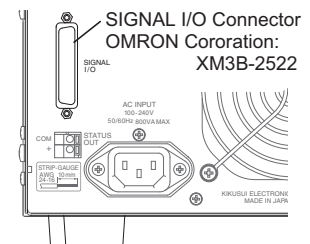

To avoid malfunctions caused by noise, use shielded-type D-sub 25-pin connectors and a cable that is 2.5 m or less in length.

For information about how to obtain replacement parts, contact your Kikusui agent or distributor.

For information about how to use these components, see the OMRON Corporation catalogs.

Wire and tool that are necessary to make the connection

Wire	Single wire: 0.32 mm (AWG28) to 0.65 mm (AWG22) in diameter
	Twisted wire: 0.32 mm ² (AWG22) to 0.08 mm ² (AWG28)
Wire stripper	A wire stripper that matches the wires listed above

SIGNAL I/O specifications

Input signal	
Low-active control input	
High-level input voltage	11 V to 15 V
Low-level input voltage	0 V to 4 V
Low-level input current	-5 mA maximum ¹
Input time width	5 ms minimum

Output signal	
Open drain output	
Output withstanding voltage	30 VDC
Output saturation voltage	Approx. 1.1 V at 25 °C
Maximum output current	400 mA in total

¹ Excluding the interlock signal

■ SIGNAL I/O connector pinout

Pin no.	Signal name	I/O	TOS5300	TOS5301	TOS5302																
1	INTERLOCK+	I	If you open the positive and negative terminals, the output is turned off, and the TOS5300 Series is switched to Protection mode. Open: The resistance between the two terminals is 1.2 kΩ or greater. Short: The resistance between the two terminals is 1 kΩ or less.																		
2	PM0	I	Panel memory selection signal. The selection signal is latched on the rising edge of the input strobe signal to recall panel memory. * The selection of memory is prioritized over TEST SEL and AUTO SEL.																		
3	PM1	I																			
						<table border="1"> <thead> <tr> <th>PM0</th> <th>PM1</th> <th>Recalled panel memory number</th> </tr> </thead> <tbody> <tr> <td>H</td> <td>H</td> <td>Memory 1</td> </tr> <tr> <td>L</td> <td>H</td> <td>Memory 2</td> </tr> <tr> <td>H</td> <td>L</td> <td>Memory 3</td> </tr> <tr> <td>L</td> <td>L</td> <td>Enables the selection of TEST SEL and AUTO SEL</td> </tr> </tbody> </table>	PM0	PM1	Recalled panel memory number	H	H	Memory 1	L	H	Memory 2	H	L	Memory 3	L	L	Enables the selection of TEST SEL and AUTO SEL
PM0	PM1	Recalled panel memory number																			
H	H	Memory 1																			
L	H	Memory 2																			
H	L	Memory 3																			
L	L	Enables the selection of TEST SEL and AUTO SEL																			
4	NC	—	—	—	—																
5	NC	—	—	—	—																
6	NC	—	—	—	—																
7	NC	—	—	—	—																
8	NC	—	—	—	—																
9	STB	I	Panel memory strobe signal input terminal.																		
10	TEST SEL	I	NA	ACW/DCW selection signal input. L: ACW. H: DCW.	Single test selection signal and auto test order selection signal. If AUTO SEL specifies single test, L: ACW and H: IR. If AUTO SEL specifies auto operation, L: ACW→IR and H: IR→ACW.																
11	AUTO SEL	I	NA	NA	Auto test/single test selection. L: Single test. H: Auto test.																
12	COM	—	Circuit common terminal.																		
13	INTERLOCK-	I	If you open the positive and negative terminals, the output is turned off, and the TOS5300 Series is switched to Protection mode. Open: The resistance between the two terminals is 1.2 kΩ or greater. Short: The resistance between the two terminals is 1 kΩ or less.																		
14	HV.ON	O	On during testing and when a voltage remains across the output terminals.	On during testing, when a voltage remains across the output terminals, and during auto tests (AUTO TEST).																	
15	TEST	O	On during testing (excluding when voltage is rising or falling).																		
16	PASS	O	On for at least 0.2 seconds (the PASS HOLD time) when a PASS judgment occurs. On continuously when the PASS HOLD time is set to HOLD.																		
17	U-FAIL	O	On continuously when an UPPER FAIL judgment occurs because a value greater than or equal to the upper limit is detected.																		
18	L-FAIL	O	On continuously when a LOWER FAIL judgment occurs because a value less than or equal to the lower limit is detected.																		
19	READY	O	On when the TOS5300 Series is waiting (when it is in the READY state).																		
20	PROTECTION	O	On when protective features have been activated.																		
21	START	I	Start signal input terminal.																		
22	STOP	I	Stop signal input terminal.																		
23	ENABLE	I	Input terminal for the start signal's ENABLE signal. If the ENABLE signal changes, the TOS5300 Series is switched to Protection mode.																		
24	+24 V	—	+24 V internal power supply output terminal; maximum output current 100 mA.																		
25	COM	—	Circuit common terminal.																		

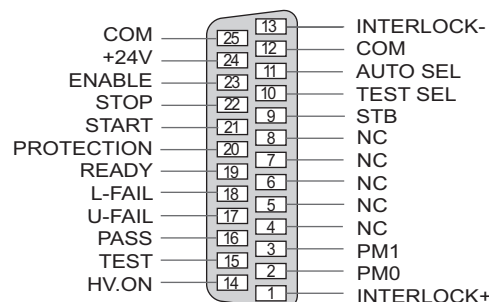

Internal construction

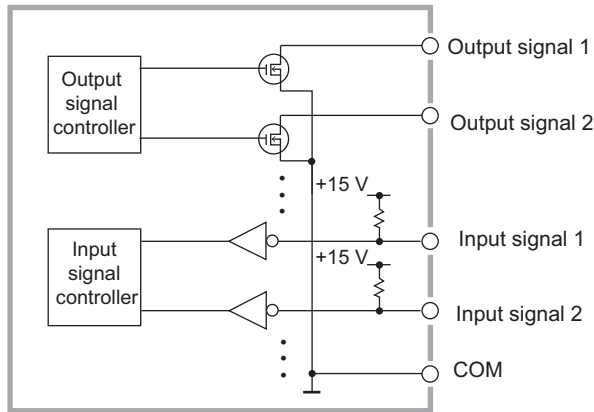

Internal construction of the SIGNAL I/O connector

The input signal circuit and the output signal circuit share the same common.

The input signals are pulled up to +15 V. If the input terminals are opened, the input signal circuit is put into the same state as when a high-level signal is applied.

Input signal usage example

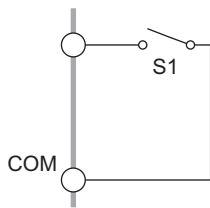

Using a make contact to control input

Use a make contact, such as a relay or switch, to set the input terminal to low level.

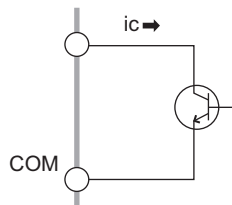

Using a logic element to control input

Use a logic element, such as a transistor, in place of the switch in the above example.

Design the circuit so that a transistor collector current (i_c) of 5 mA or greater flows.

Output signal usage example

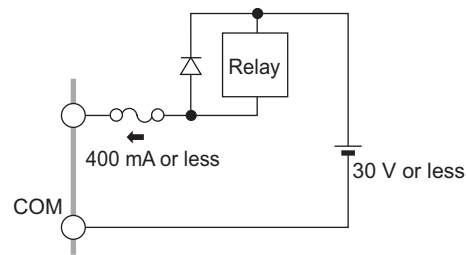

Driving a relay

Use the output signal to drive a relay.

To improve the safety of the circuit, we recommend that you insert a protection fuse or connect a diode.

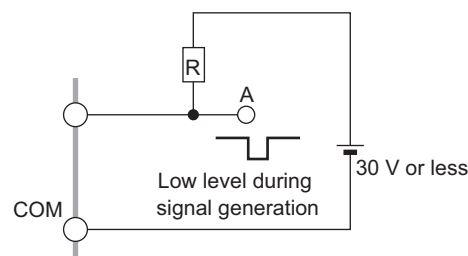

Obtaining a low-level digital signal

Use the output signal to obtain a low-level digital signal.

Starting Testing

To use the SIGNAL I/O connector to start testing, set the ENABLE signal to low level.

If the ENABLE signal changes, the TOS5300 Series is switched to Protection mode. Use the STOP signal to clear the Protection mode.

When at least 1 ms has elapsed after the READY signal was set to low level, set the START signal to low level for at least 5 ms. After a valid START signal has been detected, the READY signal is set to high level.

When the ENABLE signal is low, the START signal of the SIGNAL I/O connector is enabled, and the panel's START switch and the START input of the REMOTE terminal are both disabled.

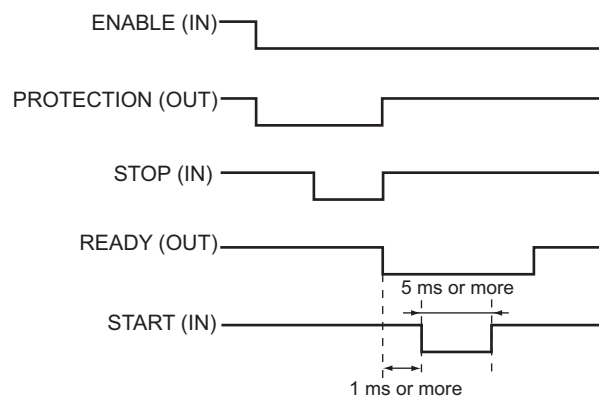

Recalling Panel Memory and Test Modes

Selecting the panel memory

The PM and STB signals are processed with the timing shown below. Check that the READY signal is low level.

The relationship between the PM0 and PM1 signals and the panel memory number that is recalled is shown in the table below.

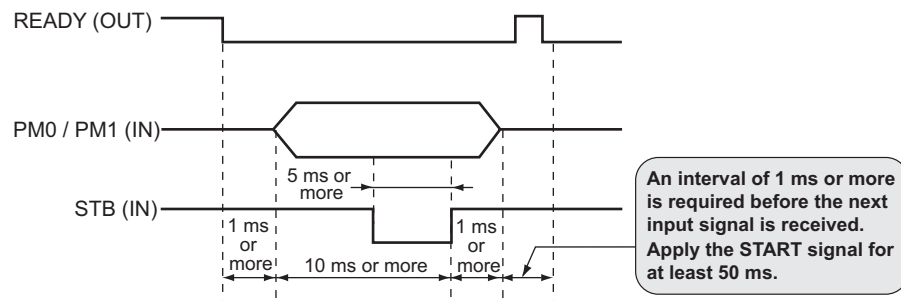

PM0	PM1	TEST SEL	AUTO SEL	Recalled panel memory number
H	H	L	L	memory 1
L	H	L	L	memory 2
H	L	L	L	memory 3
L	L	L	L	Enables TEST SEL and AUTO SEL

Selecting the test mode

The relationship between the PM0, PM1, TEST SEL, and AUTO SEL signals and the test mode that is recalled is shown in the table below.

PM0	PM1	TEST SEL	AUTO SEL	Recalled test mode
L	L	L	L	ACW
L	L	H	L	DCW 5301
				IR 5302
L	L	H	H	IR → ACW 5302
L	L	L	H	ACW → IR 5302

Interlock Feature

This feature links the TOS5300 Series to an external device to stop output appropriately. This ensures the safety of the operator.

While the interlock feature is active, even if you press the START switch or apply a start signal from an external controller, the TOS5300 Series will not perform testing. While the interlock signal is being applied, you cannot release PROTECTION mode by pressing the STOP switch or applying a stop signal.

By using the interlock feature, you can control the TOS5300 Series output from an external source. This ensures safe operation of the tester.

 p.23

The first time that you turn the POWER switch on after you purchase the TOS5300 Series, the tester will be in PROTECTION mode through the interlock feature. You can use the included SIGNAL I/O plug to easily release the PROTECTION mode.

Attaching the included SIGNAL I/O plug connects pin numbers 1 and 13, the INTERLOCK+ and INTERLOCK- pins. Only use this plug to easily release the PROTECTION mode.

When you are actually performing tests, use the interlock feature to ensure safety.

During withstanding voltage and insulation resistance tests in which you are using tools, (1) placing a cover over the DUT so that output is turned off whenever the cover is removed to prevent electric shock and (2) placing a safety fence around the work area where withstanding voltage and insulation resistance tests are being performed so that output is turned off whenever the fence is opened are both examples of effective safety measures.

■ Interlock signal input conditions

Open across terminals

- When the resistance across the positive and negative terminals is 1.2 k Ω or greater.
- If you are using transistors or an optical device, when the current across the positive and negative terminals is 5 mA or less.

■ Interlock signal release conditions

Short across terminals

- When the resistance across the positive and negative terminals is 1 k Ω or less.
- If you are using transistors or an optical device, when the current across the positive and negative terminals is 6 mA or greater.

How to use the interlock feature

When SIGNAL I/O connector pins 1 and 13 are opened, the interlock feature is enabled. When the pins are shorted, the interlock feature is released.

When the interlock feature is active, the TOS5300 Series is in PROTECTION mode. To release the interlock feature, connect the included SIGNAL I/O plug to the rear-panel SIGNAL I/O connector. Then press STOP to release PROTECTION mode.

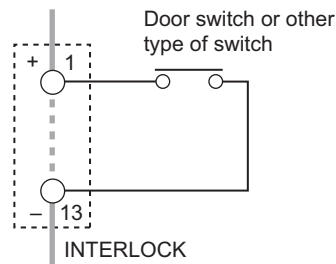

Using an open/close switch

When the contact is open, the interlock signal also becomes open, and the interlock feature is activated. To release the interlock feature, close the contact, and then press STOP or apply a STOP signal.

Use a door switch or other type of switch that has a voltage rating of 30 VDC or greater and a current rating of 10 mA or greater.

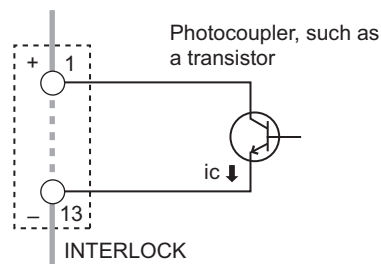

Using a transistor or optical device

When the transistor collector current is 5 mA or less, the interlock feature is activated. To release the interlock feature, allow an i_c of 6 mA or greater to flow, and then press STOP or apply a STOP signal.

STATUS OUT Connector

See p.17, p.90

This is the output connector for connecting the optional warning light unit, PL02-TOS.

Under 2. Status Signal Output on the Configuration Menu, select the status that you want to output. Select H.V ON, Test, Pass, Upper Fail, Lower Fail, Ready, Protection, or Power ON. If you select multiple items, the status that is generated will be the logical sum of the items. When the selected status is true, the TOS5300 Series generates a +24 VDC signal.

For details, see the "WARNING LIGHT PL02-TOS OPERATION MANUAL."



7

Maintenance

This chapter explains daily inspections such as measurement checks, system clock adjustment, calibration management, and battery replacement.

Pre-Test Inspection

Inspection of test leads and the judgment feature

Allow a current to flow between the HIGH VOLTAGE and LOW VOLTAGE terminals to check the judgment feature. During this inspection, the two test leads are shorted, so you can check for breaks in the test leads at the same time.

We recommend that you perform this pre-test inspection before you use the TOS5300 Series.

The test leads are consumable parts. Check them periodically for tears and breaks.



WARNING

Breaks or tears in the insulation may cause electric shock or fire. If a break or tear is found, stop using the damaged test lead immediately.

See p.26

- 1 Short the LOW test lead (black) and HIGH VOLTAGE test lead (red).**
- 2 Connect the LOW test lead (black) to the LOW VOLTAGE terminal.**
- 3 Connect the HIGH VOLTAGE test lead (red) to the HIGH VOLTAGE terminal.**

See p.47, p.49

- 4 Set the test conditions.**
For a withstanding voltage test, be sure to set the upper limit (UPPER). For an insulation resistance test, be sure to set the lower limit (LOWER).
- 5 Press START to start the test.**
- 6 If a withstanding voltage test results in a U-FAIL judgment or if an insulation resistance test results in an L-FAIL judgment, both the test leads and the TOS5300 Series judgment feature are working properly according to this simple check.**

If a U-FAIL or L-FAIL result does not occur even after you perform this check multiple times, there may be breaks in the test leads. Double-check whether this is the case. If there are no breaks in the test leads, the TOS5300 Series needs to be repaired.

To have your TOS5300 Series repaired, contact your Kikusui agent or distributor.

Time Settings and Calibration Management

The TOS5300 Series keeps track of the scheduled calibration date by using the internal system clock. When the tester is turned on after the previously set calibration period has elapsed, the message, "Calibration Protection" is displayed.

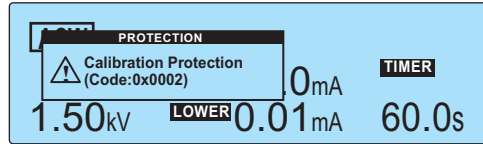

If the system clock is incorrect, set it to match the current date and time.

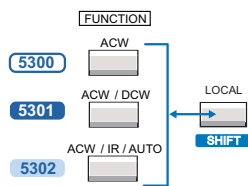

1 Press CONFIG (SHIFT+FUNCTION) to display the configuration setup screen (Configuration Menu).

2 Press 2: Up (MEMORY 2) or 3: Down (MEMORY 3) to highlight 3.Date and Time, and then press Select (↵: RECALL) to select this setting.

The 3.Date and Time screen of the Configuration Menu is displayed.

3 Press 2: Up (MEMORY 2) or 3: Down (MEMORY 3) to select the setting that you want to change, and then use the rotary knob to set the value.

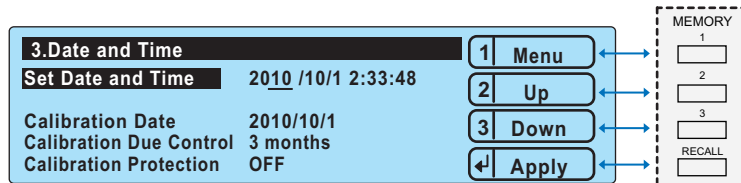

Example: Selecting the value of Set Date and Time on the 3.Date and Time screen of the Configuration Menu

The factory default settings are shown below.

Set Date and Time (the system clock)	Japan standard time at the time when the product left the factory
Calibration Date (the calibration date)	The date when the product was calibrated before it left the factory
Calibration Due Control (the calibration period)	After 12 months
Calibration Protection (notification of when the calibration period elapses)	OFF

Set Date and Time (the system clock)

Set the present date in the following format: year/month/day hour:minutes:seconds. The displayed date and time is the same as what is shown on the configuration setup screen's 3.Date and Time screen.

After you enter the date and time, press ↵:Apply (RECALL) to set it.

Calibration Date (the calibration date)

Displays the year/month/day of calibration.

Whenever you calibrate the TOS5300, save the calibration date.

See p.55

Calibration Due Control (the calibration period)

The next day that calibration is necessary is set as a period after the previous calibration date. This setting can be set to a value in the range of 3 months to 36 months, and it can also be set to infinity.

Calibration Protection (notification of when the calibration period elapses)

 **Memo**

When this setting is set to ON, the screen of the TOS5300 Series remains in the PROTECTION state even if you press STOP. Press CONFIG (SHIFT+FUNCTION) to display the configuration setup screen.

 See p.88 , p.91

You can set how the TOS5300 Series will operate when the specified number of days after calibration have elapsed.

When this calibration period elapses, the message "Calibration Protection (Code:0x0002)" will be displayed when you turn the TOS5300 Series on.

If Calibration Protection is set to ON, the TOS5300 Series displays the message, and then switches to the PROTECTION state. In this state, you cannot use the TOS5300 Series.

To continue using the TOS5300 Series, press STOP and then CONFIG (SHIFT+FUNCTION) to display the configuration setup screen. Next, select 3.Date and Time, and then set Calibration Protection to OFF.

If you set Calibration Protection to OFF, you can continue using the TOS5300 Series by pressing STOP to clear the PROTECTION state.

Calibration

The TOS5300 Series is calibrated before shipment. To maintain long-term performance, we recommend periodic calibration.

To perform periodic calibration, set the calibration period (Calibration Due Control). To have your TOS5300 Series calibrated, contact your Kikusui agent or distributor.

Backup Battery Replacement

The TOS5300 Series uses a lithium battery for memory backup.

When the battery is low, the TOS5300 Series cannot store data such as test conditions. (Battery life varies depending on the environment.) As a guideline, we recommend that the battery be replaced once every three years. You can also have the TOS5300 Series inspected and cleaned at the same time.

You must open the cover to replace the backup battery. For battery replacement, contact your Kikusui agent or distributor.



8

Specifications

This chapter contains the specifications and gives the dimensions of the TOS5300 Series.

Unless specified otherwise, the specifications are for the following settings and conditions.

- The warm-up time is 30 minutes.
- TYP: These are typical values. These values do not guarantee the performance of the product.
- rdng: Indicates the readout value.
- set: Indicates a setting.
- f.s: Indicates full scale.

Withstanding voltage tester

		TOS5300	TOS5301	TOS5302	
AC output section	Output range	0.05 kV to 5.00 kV			
	Accuracy	±(2 % of set + 20 V) when no load is connected			
	Setting range	0.00 kV to 5.50 kV			
	Resolution	10-volt steps			
	Max. rated output ¹	500 VA (5 kV/100 mA)			
	Max. rated voltage	5 kV			
	Max. rated current	100 mA (when the output voltage is 0.5 kV or greater)			
	Transformer rating	500 VA			
	Output voltage waveform ²	Sine			
	Distortion	If the output voltage is 0.5 kV or more: 3 % or less (when no load or a pure resistive load is connected).			
	Frequency	50 Hz or 60 Hz			
	Accuracy	±0.5 % (excluding during voltage rise time)			
	Voltage regulation	10 % or less (when changing from maximum rated load to no load)			
	Input voltage variation	±0.3 % (5 kV when no load is connected; power supply voltage: 90 V to 250 V)			
	Short-circuit current	200 mA or more (when the output voltage is 1.0 kV or greater)			
Output method	PWM switching				
DC output section	Output range		0.05 kV to 6.00 kV		
	Accuracy		±(2 % of set + 20 V) when no load is connected		
	Setting range		0.00 kV to 6.20 kV		
	Resolution		10 V steps		
	Max. rated output ¹		50 W (5 kV/10 mA)		
	Max. rated voltage		6 kV		
	Max. rated current		10 mA		
	Ripple (TYP)	5 kV when no load is connected	—	50 Vp-p	—
		Max. rated load		100 Vp-p	
	Voltage regulation			3 % or less (when changing from maximum rated load to no load)	
	Short-circuit current (TYP)			40 mA (when generating 6 kV output)	
Discharge feature			Forced discharge after test completion (discharge resistance: 125 kΩ)		
Start voltage	The voltage at the start of withstanding voltage tests can be set to 50 % of the test voltage.				
Limit voltage	The test voltage upper limit can be set. AC: 0.00 kV to 5.50 kV. DC: 0.00 kV to 6.20 kV.				
Output voltage monitor feature	If output voltage exceeds the specified value + 350 V or is lower than the specified value - 350 V, output is turned off, and protective features are activated.				

			TOS5300	TOS5301	TOS5302																				
Voltmeter	Analog	Scale	6 kV AC/DC f.s																						
		Accuracy	±5 % f.s																						
		Indication	Mean-value response/rms scale																						
	Digital	Measurement range	0.000 kV to 6.500 kV AC/DC																						
		Display	□ . □□□ kV																						
		Accuracy	V < 500 V: ±(1.5 % of rdng + 20 V); V ≥ 500 V: ±1.5 % of rdng																						
		Response ³	True rms/ Mean-value response rms display Can be switched																						
Hold feature	After a test is finished, the measured voltage is retained until the PASS or FAIL judgment is cleared.																								
Ammeter	Digital	Measurement range	AC: 0.00 mA to 110 mA	AC: 0.00 mA to 110 mA DC: 0.00 mA to 11 mA	AC: 0.00 mA to 110 mA																				
		Display	i = measured current																						
			i < 1 mA	1 mA ≤ i < 10 mA	10 mA ≤ i < 100 mA	100 mA ≤ i																			
			□□□ μA	□ . □□□ mA	□□ . □□ mA	□□□ . □ mA																			
		Accuracy ⁴	1.00 mA ≤ i: ±(1.5 % of rdng); i < 1.00 mA: ±(1.5 % of rdng + 30 μA)																						
		Response ³	True rms/ Mean-value response rms display Can be switched																						
Hold feature	After a test is finished, the measured current is retained until the PASS judgment is cleared.																								
Judgment feature	Judgment method and judgment operation	<table border="1"> <thead> <tr> <th>Judgment</th> <th>Judgment method</th> <th>Display</th> <th>Buzzer</th> <th>SIGNAL I/O</th> </tr> </thead> <tbody> <tr> <td>UPPER FAIL</td> <td>If a current that is greater than or equal to the upper limit is detected, the output is turned off, and an UPPER FAIL judgment occurs.</td> <td>FAIL LED lights OVER is displayed on the screen</td> <td>ON</td> <td>Generates a U-FAIL signal</td> </tr> <tr> <td>LOWER FAIL</td> <td>If a current that is less than or equal to the lower limit is detected, the output is turned off, and a LOWER FAIL judgment occurs. This judgment is not performed during voltage rise time (Rise Time) of all tests and during the voltage fall time (Fall Time) of AC withstanding voltage tests.</td> <td>FAIL LED lights UNDER is displayed on the screen</td> <td>ON</td> <td>Generates an L-FAIL signal</td> </tr> <tr> <td>PASS</td> <td>If the specified time elapses without any problems, the output is turned off, and a PASS judgment occurs.</td> <td>PASS LED lights</td> <td>ON</td> <td>Generates a PASS signal</td> </tr> </tbody> </table>				Judgment	Judgment method	Display	Buzzer	SIGNAL I/O	UPPER FAIL	If a current that is greater than or equal to the upper limit is detected, the output is turned off, and an UPPER FAIL judgment occurs.	FAIL LED lights OVER is displayed on the screen	ON	Generates a U-FAIL signal	LOWER FAIL	If a current that is less than or equal to the lower limit is detected, the output is turned off, and a LOWER FAIL judgment occurs. This judgment is not performed during voltage rise time (Rise Time) of all tests and during the voltage fall time (Fall Time) of AC withstanding voltage tests.	FAIL LED lights UNDER is displayed on the screen	ON	Generates an L-FAIL signal	PASS	If the specified time elapses without any problems, the output is turned off, and a PASS judgment occurs.	PASS LED lights	ON	Generates a PASS signal
		Judgment	Judgment method	Display	Buzzer	SIGNAL I/O																			
		UPPER FAIL	If a current that is greater than or equal to the upper limit is detected, the output is turned off, and an UPPER FAIL judgment occurs.	FAIL LED lights OVER is displayed on the screen	ON	Generates a U-FAIL signal																			
		LOWER FAIL	If a current that is less than or equal to the lower limit is detected, the output is turned off, and a LOWER FAIL judgment occurs. This judgment is not performed during voltage rise time (Rise Time) of all tests and during the voltage fall time (Fall Time) of AC withstanding voltage tests.	FAIL LED lights UNDER is displayed on the screen	ON	Generates an L-FAIL signal																			
		PASS	If the specified time elapses without any problems, the output is turned off, and a PASS judgment occurs.	PASS LED lights	ON	Generates a PASS signal																			
		<ul style="list-style-type: none"> If PASS HOLD is enabled, the PASS signal is generated continuously until the TOS5300 Series receives a STOP signal. The UPPER FAIL and LOWER FAIL signals are generated continuously until the TOS5300 Series receives a STOP signal. The FAIL and PASS buzzer volume levels can be changed. For PASS judgments, the length of time that the buzzer sounds for is fixed to 0.2 seconds. Even if PASS HOLD is enabled, the buzzer turns off after 0.2 seconds. 																							
		Upper limit setting	AC: 0.01 mA to 110 mA	AC: 0.01 mA to 110 mA DC: 0.01 mA to 11 mA	AC: 0.01 mA to 110 mA																				
		Lower limit setting	AC: 0.01 mA to 110 mA / OFF	AC: 0.01 mA to 110 mA / OFF DC: 0.01 mA to 11 mA / OFF	AC: 0.01 mA to 110 mA / OFF																				
		Judgment accuracy ⁴	1.00 mA ≤ i: ±(1.5 % of set), i < 1.00 mA: ±(1.5 % of set + 30 μA)																						
		Current detection method	Calculates the current's true rms value or mean-value and compares this value with the reference value																						
Calibration	Calibrated with the rms of a sine wave using a pure resistive load																								

		TOS5300	TOS5301	TOS5302
Time	Voltage rise time	0.1 s to 10.0 s		
	Resolution	0.1 s		
	Voltage fall time	0.1 s / OFF (only enabled when a PASS judgment occurs)		
	Test time	0.1 s to 999 s, can be turned off (TIMER OFF)		
	Resolution	0.1 s to 99.9 s: 0.1 s. 100 s to 999 s: 1 s.		
Accuracy	±(100 ppm + 20 ms) AC: Excluding Fall Time DC: Rise Time Add ±50 ms at 1 kV or more, Add ±100 ms at less than 1kV.			

- Regarding the output time limits:
 Taking size, weight, and cost into consideration, the heat dissipation capability of the voltage generator that is used for withstanding voltage tests has been designed to be one half that of the rated output. Use the TOS5300 Series within the following limits. If you use the product in a manner that exceeds these limits, the output section may overheat, and the internal protection circuits may be activated. If this happens, stop testing, and wait until the TOS5300 Series returns to its normal temperature.

Ambient temperature	Upper limit	Pause time	Output time
t ≤ 40 °C	AC	50 mA < i ≤ 110 mA	Greater than or equal to the output time
		i ≤ 50 mA	Not necessary
	DC	5 mA < i ≤ 11 mA	Greater than or equal to the output time
		i ≤ 5 mA	Greater than or equal to the wait time (WAIT TIME)

(Output time = voltage rise time + test time + voltage fall time)

- Regarding the test voltage waveform:
 Waveform distortions may occur if an DUT whose capacitance is dependent on voltage (for example, an DUT that consists of ceramic capacitors) is connected as the load. However, if the test voltage is 1.5 kV, the effect of a capacitance of 1 000 pF or less can be ignored. Because the product's high-voltage power supply uses the PWM switching method, if the test voltage is 500 V or less, the switching and spike noise proportions are large. The lower the test voltage, the greater the waveform is distorted.
- For both True rms and Mean-value response, 50 ms or above response time is required to satisfy the measurement accuracy.
- Regarding ammeter and judgment accuracy:
 During AC withstanding voltage tests, current also flows in the stray capacitance of items such as the measurement leads and jigs. This current that flows in the stray capacitances is added to the current that flows in the DUT, and the sum of these currents is measured. Especially if you want to perform judgments with high sensitivity and accuracy, it is necessary to consider methods to limit the current that flows in these stray capacitances, such as by adding upper and lower limits.

Output voltage	1 kV	2 kV	3 kV	4 kV	5 kV
When using 350 mm long test leads that are suspended in air (TYP)	2 μA	4 μA	6 μA	8 μA	10 μA
When using the accessory, high-voltage test lead TL31-TOS (TYP)	16 μA	32 μA	48 μA	64 μA	80 μA

Insulation resistance test section

		TOS5302							
Output section	Output voltage	25 V, 50 V, 100 V, 125 V, 250 V, 500 V, 1000 VDC (negative)							
		Accuracy	-0 %, +5 %						
	Max. rated load	1 W (-1000 VDC/1 mA)							
	Max. rated current	1 mA							
	Ripple	1000 V when no load is connected	2 Vp-p or less						
		Max. rated load	10 Vp-p or less						
	Voltage regulation	1 % or less (when changing from maximum rated load to no load)							
	Short-circuit current	12 mA or less							
	Discharge feature	Forced discharge after test completion (discharge resistance: approx. 25 kΩ)							
	Limit voltage	The test voltage upper limit can be set: 25 V, 50 V, 100 V, 125 V, 250 V, 500 V, 1000 V							
Output voltage monitor feature	If output voltage exceeds "10 % of set + 10 V" or is lower than "-(10 % of set + 10 V)," output is turned off, and protective features are activated.								
Voltmeter	Analog	Scale	6 kV AC/DC f.s						
		Accuracy	±5 % f.s						
		Indication	Mean-value response/rms scale						
	Digital	Measurement range	0 V to -1200 V						
		Display	Measured voltage	V < 100 V 100 V ≤ V < 1000 V 1000 V ≤ V					
			Display	□□ V □□□ V □□□□ V					
Accuracy	± (1 % of rdng + 1 V)								
Resistance meter	Measurement range / measurement accuracy ^{1, 2}	25 V	0.03 MΩ ≤ R ≤ 25 MΩ / ±(2 % of rdng + 2 digits) 25 MΩ < R ≤ 125 MΩ / ±5 % of rdng 125 MΩ < R ≤ 250 MΩ / ±10 % of rdng						
		50 V	0.05 MΩ ≤ R ≤ 50 MΩ / ±(2 % of rdng + 2 digits) 50 MΩ < R ≤ 250 MΩ / ±5 % of rdng 250 MΩ < R ≤ 500 MΩ / ±10 % of rdng						
		100 V	0.100 MΩ ≤ R ≤ 100 MΩ / ±2 % of rdng 100 MΩ < R ≤ 500 MΩ / ±5 % of rdng 500 MΩ < R ≤ 1 GΩ / ±10 % of rdng						
		125 V	0.125 MΩ ≤ R ≤ 125 MΩ / ±2 % of rdng 125 MΩ < R ≤ 625 MΩ / ±5 % of rdng 625 MΩ < R ≤ 1.25 GΩ / ±10 % of rdng						
		250 V	0.250 MΩ ≤ R ≤ 250 MΩ / ±2 % of rdng 250 MΩ < R ≤ 1.25 GΩ / ±5 % of rdng 1.25 GΩ < R ≤ 2.5 GΩ / ±10 % of rdng						
		500 V	0.50 MΩ ≤ R ≤ 500 MΩ / ±2 % of rdng 500 MΩ < R ≤ 2.5 GΩ / ±5 % of rdng 2.5 GΩ < R ≤ 5 GΩ / ±10 % of rdng						
		1000 V	1 MΩ ≤ R < 1 GΩ / ±2 % of rdng 1 GΩ ≤ R ≤ 5 GΩ / ±5 % of rdng						
	Display ²	<table border="1"> <tr> <td>25 kΩ ≤ R < 1.00 MΩ</td> <td>1.00 MΩ ≤ R < 10.0 MΩ</td> <td>10.0 MΩ ≤ R < 100 MΩ</td> </tr> <tr> <td>□□□ kΩ</td> <td>□ . □□ MΩ</td> <td>□□ . □ MΩ</td> </tr> </table>		25 kΩ ≤ R < 1.00 MΩ	1.00 MΩ ≤ R < 10.0 MΩ	10.0 MΩ ≤ R < 100 MΩ	□□□ kΩ	□ . □□ MΩ	□□ . □ MΩ
		25 kΩ ≤ R < 1.00 MΩ	1.00 MΩ ≤ R < 10.0 MΩ	10.0 MΩ ≤ R < 100 MΩ					
	□□□ kΩ	□ . □□ MΩ	□□ . □ MΩ						
<table border="1"> <tr> <td>100.0 MΩ ≤ R < 1.00 GΩ</td> <td>1.00 GΩ ≤ R ≤ 9.99 GΩ</td> </tr> <tr> <td>□□□ MΩ</td> <td>□ . □□ GΩ</td> </tr> </table>		100.0 MΩ ≤ R < 1.00 GΩ	1.00 GΩ ≤ R ≤ 9.99 GΩ	□□□ MΩ	□ . □□ GΩ				
100.0 MΩ ≤ R < 1.00 GΩ	1.00 GΩ ≤ R ≤ 9.99 GΩ								
□□□ MΩ	□ . □□ GΩ								
Hold feature	After a test is finished, the measured resistance is retained until the PASS judgment is cleared.								

		TOS5302																				
Current detection response speed		Can be switched between three levels: Fast, Mid, Slow																				
Judgment feature	Judgment method and judgment operation	<table border="1"> <thead> <tr> <th>Judgment</th> <th>Judgment method</th> <th>Display</th> <th>Buzzer</th> <th>SIGNAL I/O</th> </tr> </thead> <tbody> <tr> <td>UPPER FAIL</td> <td>If a resistance that is greater than or equal to the upper limit is detected, the output is turned off, and an UPPER FAIL judgment occurs. This judgment is not performed during voltage rise time (Rise Time).</td> <td>FAIL LED lights; OVER is displayed on the screen</td> <td>ON</td> <td>Generates a U-FAIL signal</td> </tr> <tr> <td>LOWER FAIL</td> <td>If a resistance that is less than or equal to the lower limit is detected or if a problem occurs during the voltage rise time (Rise Time), the output is turned off, and a LOWER FAIL judgment occurs.</td> <td>FAIL LED lights; UNDER is displayed on the screen</td> <td>ON</td> <td>Generates an L-FAIL signal</td> </tr> <tr> <td>PASS</td> <td>If the specified time elapses without any problems, the output is turned off, and a PASS judgment occurs.</td> <td>PASS LED lights</td> <td>ON</td> <td>Generates a PASS signal</td> </tr> </tbody> </table>	Judgment	Judgment method	Display	Buzzer	SIGNAL I/O	UPPER FAIL	If a resistance that is greater than or equal to the upper limit is detected, the output is turned off, and an UPPER FAIL judgment occurs. This judgment is not performed during voltage rise time (Rise Time).	FAIL LED lights; OVER is displayed on the screen	ON	Generates a U-FAIL signal	LOWER FAIL	If a resistance that is less than or equal to the lower limit is detected or if a problem occurs during the voltage rise time (Rise Time), the output is turned off, and a LOWER FAIL judgment occurs.	FAIL LED lights; UNDER is displayed on the screen	ON	Generates an L-FAIL signal	PASS	If the specified time elapses without any problems, the output is turned off, and a PASS judgment occurs.	PASS LED lights	ON	Generates a PASS signal
		Judgment	Judgment method	Display	Buzzer	SIGNAL I/O																
		UPPER FAIL	If a resistance that is greater than or equal to the upper limit is detected, the output is turned off, and an UPPER FAIL judgment occurs. This judgment is not performed during voltage rise time (Rise Time).	FAIL LED lights; OVER is displayed on the screen	ON	Generates a U-FAIL signal																
		LOWER FAIL	If a resistance that is less than or equal to the lower limit is detected or if a problem occurs during the voltage rise time (Rise Time), the output is turned off, and a LOWER FAIL judgment occurs.	FAIL LED lights; UNDER is displayed on the screen	ON	Generates an L-FAIL signal																
	PASS	If the specified time elapses without any problems, the output is turned off, and a PASS judgment occurs.	PASS LED lights	ON	Generates a PASS signal																	
<ul style="list-style-type: none"> • If PASS HOLD is enabled, the PASS signal is generated continuously until the TOS5300 Series receives a STOP signal. • The UPPER FAIL and LOWER FAIL signals are generated continuously until the TOS5300 Series receives a STOP signal. • The FAIL and PASS buzzer volume levels can be changed. • For PASS judgments, the length of time that the buzzer sounds for is fixed to 0.2 seconds. Even if PASS HOLD is enabled, the buzzer turns off after 0.2 seconds. 																						
Upper limit setting range	0.03 MΩ to 5.00 GΩ																					
Lower limit setting range	0.03 MΩ to 5.00 GΩ																					
Judgment accuracy (the same for UPPER and LOWER)	Measurement accuracy + 2 digits Humidity: 20 %rh to 70 %rh (no condensation). No interference caused by wobbly test leads or other problems. For judgments of 5 μA or less, a test time of at least 1.0 seconds is necessary. If the current detection response speed is set to Mid, a test time of at least 0.3 seconds is necessary. If the current detection response speed is set to Slow, a test time of at least 0.5 seconds is necessary.																					
Time	Voltage rise time	10 ms (TYP)																				
	Test time	0.1 s to 999 s, can be turned off (TIMER OFF)																				
	Resolution	0.1 s to 99.9 s: 0.1 s. 100 s to 999 s: 1 s.																				
	Accuracy	± (100 ppm + 20 ms)																				

- 1 Humidity: 20 %rh to 70 %rh (no condensation). No bends in the test leads.
- 2 R = measured insulation resistance

Other features

	TOS5300	TOS5301	TOS5302
Double action feature (Double Action)	Tests can only be started by pressing and releasing STOP and then pressing START within 0.5 seconds of releasing the STOP switch.		
Length of time to maintain a PASS judgment result (Pass Hold)	You can set the length of time to maintain a PASS judgment: 50 ms, 100 ms, 200 ms, 1 s, 2 s, 5 s, or HOLD.		
Momentary feature (Momentary)	Tests are only executed while the START switch is held down.		
Fail mode feature (Fail Mode)	This feature enables you to prevent remotely transmitted stop signals from clearing FAIL judgments and PROTECTION modes.		
Timer feature (TIMER)	This feature finishes tests when the specified time elapses.		
Output voltage monitor feature (Volt Error)	If output voltage exceeds "setting + 350 V" or is lower than "setting - 350 V," the TOS5300 Series switches to PROTECTION mode, output is turned off, and testing finishes.		
Memory	Up to three sets of test conditions can be saved to memory.		
Key lock	Locks panel key operations (settings and changes).		
Protective features	Under any of the following conditions, the TOS5300 Series switches to the PROTECTION state, immediately turns output off, and stops testing. A message is displayed on the screen.		
Interlock Protection	An interlock signal has been detected.		
Power Supply Protection	An error was detected in the power supply.		
Volt Error Protection	While monitoring the output voltage, a voltage outside of the rated limits was detected. AC or DC withstanding voltage tests: ± 350 V Insulation resistance test: $\pm(10\%$ of set + 10 V)		
Over Load Protection	During a withstanding voltage test, a value that is greater than or equal to the output limit power was specified. AC withstanding voltage test: 550 VA. DC withstanding voltage test: 55 VA.		
Over Heat Protection	The internal temperature of the TOS5300 Series became too high.		
Over Rating Protection	During a withstanding voltage test, the output current was generated for a length of time that exceeds the regulated time.		
Calibration Protection	The specified calibration period has elapsed.		
Remote Protection	A connection to or disconnection from the front-panel REMOTE connector was detected.		
SIGNAL I/O Protection	The rear-panel SIGNAL I/O connector's ENABLE signal has changed.		
USB Protection	The USB connector has been disconnected while the TOS5300 Series was being controlled through the USB interface.		
System clock	Set in the following format: year/month/day hour/minutes/seconds.		
Calibration date	Set when the TOS5300 Series is calibrated.		
Calibration period setting	Sets the period before the next calibration is necessary.		
Notification of when the calibration period elapses	Sets the operation that is performed when the specified calibration period elapses. When the TOS5300 Series turns on, it can display a notification or switch to the protection mode and disable testing.		

Interfaces

		TOS5300	TOS5301	TOS5302															
USB		USB Specification 2.0, Standard Type B connector																	
REMOTE		Front-panel 9-pin MINI DIN connector. By connecting an optional device to this connector, you can control the starting and stopping of tests remotely.																	
SIGNAL I/O		Rear-panel D-sub 25-pin connector																	
Output specifications	Output method	Open drain output (4.5 VDC to 30 VDC)																	
	Output withstanding voltage	30 VDC																	
	Output saturation voltage	Approx. 1.1 V at 25 °C																	
	Maximum output current	400 mA in total																	
Input specifications ¹	High-level input voltage	11 V to 15 V																	
	Low-level input voltage	0 V to 4 V																	
	Low-level input current	5 mA max.																	
	Input time width	5 ms minimum																	
1 INTERLOCK+	I	If you open the positive and negative terminals, the output is turned off, and the TOS5300 Series is switched to Protection mode. Open: If the resistance between the terminals is 1.2 kΩ or greater. Short: If the resistance between the terminals is 1 kΩ or less.																	
2 PM0	I	Panel memory selection signal. The selection signal is latched on the rising edge of the input strobe signal to recall panel memory.	<table border="1"> <thead> <tr> <th>PM0</th> <th>PM1</th> <th>Recalled panel memory number</th> </tr> </thead> <tbody> <tr> <td>H</td> <td>H</td> <td>Memory 1</td> </tr> <tr> <td>L</td> <td>H</td> <td>Memory 2</td> </tr> <tr> <td>H</td> <td>L</td> <td>Memory 3</td> </tr> <tr> <td>L</td> <td>L</td> <td>Enables the selection of TEST SEL and AUTO SEL.</td> </tr> </tbody> </table>		PM0	PM1	Recalled panel memory number	H	H	Memory 1	L	H	Memory 2	H	L	Memory 3	L	L	Enables the selection of TEST SEL and AUTO SEL.
PM0	PM1	Recalled panel memory number																	
H	H	Memory 1																	
L	H	Memory 2																	
H	L	Memory 3																	
L	L	Enables the selection of TEST SEL and AUTO SEL.																	
3 PM1	I	* The selection of memory is prioritized over TEST SEL and AUTO SEL.																	
4 NC	—																		
5 NC	—																		
6 NC	—																		
7 NC	—																		
8 NC	—																		
9 STB	I	Panel memory strobe signal input terminal.																	
10 TEST SEL	I	NA	ACW/DCW selection signal input. L: ACW. H: DCW.	Single test selection signal and auto test order selection signal. If AUTO SEL specifies single test, L: ACW and H: IR. If AUTO SEL specifies auto operation, L: ACW→IR and H: IR→ACW.															
11 AUTO SEL	I	NA	NA	Auto test/single test selection. L: Single test. H: Auto test.															
12 COM	—	Circuit common terminal.																	
13 INTERLOCK-	I	If you open the positive and negative terminals, the output is turned off, and the TOS5300 Series is switched to Protection mode. Open: If the resistance between the terminals is 1.2 kΩ or greater. Short: If the resistance between the terminals is 1 kΩ or less.																	
14 HV.ON	O	On during testing and when a voltage remains across the output terminals.	On during testing, when a voltage remains across the output terminals, and during auto tests (AUTO TEST).																
15 TEST	O	On during testing (excluding when voltage is rising or falling).																	
16 PASS	O	On for approximately 0.2 seconds when a PASS judgment occurs. On continuously when the PASS HOLD time is set to HOLD.																	
17 U-FAIL	O	On continuously when UPPER FAIL results from judgment because a value greater than or equal to the upper limit is detected.																	

		TOS5300	TOS5301	TOS5302
SIGNAL I/O (continued)				
18 L-FAIL	O	On continuously when LOWER FAIL results from judgment because a value less than or equal to the lower limit is detected.		
19 READY	O	On when the TOS5300 Series is waiting (when it is in the READY state).		
20 PROTECTION	O	On when protective features have activated (the TOS5300 Series is in the Protection state).		
21 START	I	Start signal input terminal.		
22 STOP	I	Stop signal input terminal.		
23 ENABLE	I	Start signal enable signal input terminal.		
24 +24V	—	+24 V internal power supply output terminal; maximum output current 100 mA.		
25 COM	—	Circuit common terminal.		
STATUS SIGNAL OUTPUT		Output terminal for a warning light.		
	+ Terminal	A +24 V signal is generated from this terminal when output has been turned on.		
	COM	+24 V circuit common terminal		

- 1 The input signals are all low-active control. The input terminal is pulled up to +15V by a resistor. Leaving the input terminal open is equivalent to applying a high level signal.

General

		TOS5300	TOS5301	TOS5302
Display		VFD: 256 × 64 dots + 4 status indicators		
Backup battery life		3 years (at 25 °C or 77 °F)		
Environment	Installation location		Indoors, at a height of up to 2000 m	
	Spec guaranteed range	Temperature	5 °C to 35 °C (41 °F to 95 °F)	
		Humidity	20 %rh to 80 %rh (no condensation)	
	Operating range	Temperature	0 °C to 40 °C (32 °F to 104 °F)	
		Humidity	20 %rh to 80 %rh (no condensation)	
	Storage range	Temperature	-20 °C to 70 °C (-4 °F to 158 °F)	
Humidity		90 %rh or less (no condensation)		
Power supply	Nominal voltage range (allowable voltage range)		100 VAC to 240 VAC (90 VAC to 250 VAC)	
	Power consumption	When no load is connected (READY)	100 VA or less	
		When rated load is connected	800 VA max.	
	Allowable frequency range		47 Hz to 63 Hz	
Insulation resistance (between AC LINE and the chassis)		30 MΩ or more (500 VDC)		
Withstanding voltage (between AC LINE and the chassis)		1 400 VAC, 2 seconds (Routine test) / 1 500 VAC, 1 minutes (Type test)		
Earth continuity		25 AAC, 0.1 Ω or less		
Electromagnetic compatibility ^{1 2}		Complies with the requirements of the following directive and standards. EMC Directive 2014/30/EU EN 61326-1 (Class A ³) EN 55011 (Class A ³ , Group 1 ⁴) EN 61000-3-2 EN 61000-3-3 Applicable under the following conditions The maximum length of all cabling and wiring connected to the TOS5300 is less than 2.5 m. Shielded cables are being used when using the SIGNAL I/O. The high-voltage test lead TL31-TOS is being used. Electrical discharges are not occurring outside the DUT.		
Safety ¹		Complies with the requirements of the following directive and standard. Low Voltage Directive 2014/35/EU ² EN 61010-1 (Class I ⁵ , Pollution degree 2 ⁶)		

Dimensions		See "Outline drawing."		
Weight		Approx. 14 kg (30.9 lb.)	Approx. 15 kg (33.1 lb.)	Approx. 14 kg (30.9 lb.)
Accessories	Power cord	1 pc.		
	High-voltage test lead (TL31-TOS)	1 set (1 red wire and 1 black wire, each with alligator clips); 1.5 m		
	D-sub 25-pin plug	1 set ; assembly type		
	High-voltage warning sticker	1 pc.		
	User's manual	1 pc.		
	CD-R	1 pc.		

- 1 Does not apply to specially ordered or modified TOS5300s.
- 2 Limited to products that have the CE mark on their panels. Not be in compliance with EMC limits unless the ferrite core is attached on the cable for connection of J1 connector.
- 3 This is a Class A equipment. The TOS5300 is intended for use in an industrial environment. This product may cause interference if used in residential areas. Such use must be avoided unless the user takes special measures to reduce electromagnetic emissions to prevent interference to the reception of radio and television broadcasts.
- 4 This is a Group 1 equipment. The TOS5300 does not generate and/or use intentionally radio-frequency energy, in the form of electromagnetic radiation, inductive and/or capacitive coupling, for the treatment of material or inspection/analysis purpose.
- 5 This is a Class I equipment. Be sure to ground the TOS5300's protective conductor terminal. The safety of this product is only guaranteed when the product is properly grounded.
- 6 Pollution is addition of foreign matter (solid, liquid or gaseous) that may produce a reduction of dielectric strength or surface resistivity. Pollution Degree 2 assumes that only non-conductive pollution will occur except for an occasional temporary conductivity caused by condensation.

Outline drawing

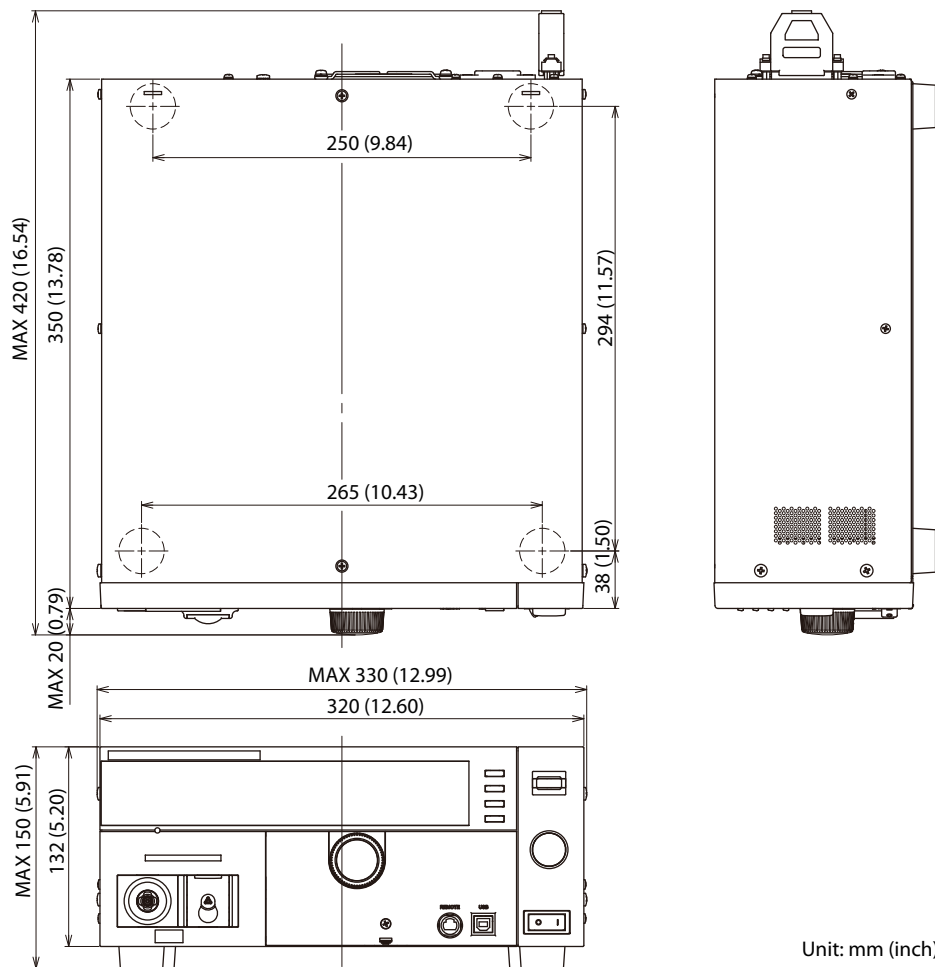



Appendix

- A List of Default Settings
- B Configuration Settings
- C Protective Features
- D Timing chart
- E Troubleshooting

A List of Default Settings

Initializing the TOS5300 Series

While holding down SHIFT, turn the POWER switch on. "Initializing" will be displayed in the lower right of the firmware version display screen, and the TOS5300 Series will be initialized.

When you initialize the TOS5300 Series, all settings (such as test conditions) and saved data are reset to the default values shown below.

TOS5302 WITHSTANDING VOLTAGE /
INSULATION RESISTANCE TESTER
Version 1.00

KIKUSUI ELECTRONICS CORP.

Initializing...

Default values

Item	Setting after initialization	
Withstanding voltage test conditions (ACW)	Measurement method	RMS
	Test voltage	0 V
	Test voltage's limit voltage	5.50 kV
	Upper limit	0.02 mA
	Lower limit	0.01 mA
	Lower limit on and off	OFF
	Test time	0.1 s
	Test timer on and off	ON
	Start voltage on and off	OFF
	Voltage rise time	0.1 s
	Voltage fall time	OFF
	Test voltage frequency	50 Hz
	Withstanding voltage test conditions (DCW)	Test voltage
Test voltage's limit voltage		6.2 kV
Upper limit		0.02 mA
Lower limit		0.01 mA
Lower limit on and off		OFF
Test time		0.1 s
Test timer on and off		ON
Start voltage on and off		OFF
Voltage rise time		0.1 s
Judgment wait time		0.1 s
Insulation resistance test conditions (IR)	Test voltage	25 V
	Test voltage's limit voltage	1000 V
	Upper limit	100 MΩ
	Upper limit on and off	OFF
	Current detection response speed	Mid
	Lower limit	1.00 MΩ

Item	Setting after initialization		
	Test timer on and off		ON
	Test time		0.1 s
	Test time on and off		ON
	Judgment wait time		0.1 s
Test mode			ACW
Panel memory			See p.87
Interface setting			USB
Configuration settings	Test Mode	Double Action	OFF
		Pass Hold	50 ms
		Momentary	OFF
		Fail Mode	OFF
	Buzzer Volume Level	Pass	3
		Fail	5
	Status Signal Output	H.V ON	OFF
		Test	OFF
		Pass	OFF
		Upper Fail	OFF
		Lower Fail	OFF
		Ready	OFF
		Protection	OFF
		Power ON	OFF
	Date and Time	Set Date and Time	No change ¹
		Calibration	
		Calibration Due Control	12 months
		Calibration Protection	OFF

¹ The factory default settings are shown below.

Set Date and Time: Japan standard time at the time when the product left the factory.

Calibration Date: The date when the product was calibrated before it left the factory.

App

Default panel memory values

There are three panel memory entries. Initially, these entries all contain AC withstanding voltage test conditions that comply with safety standards.

If you initialize the TOS5300 Series, the panel memory entries are also returned to their default values.

Memory number	Setting	Setting after initialization
1 to 3	Test mode	ACW
	Test voltage	0.00 kV
	Limit voltage	5.5 kV
	Upper limit	0.02 mA
	Lower limit	0.01 mA
	Test time	0.1 s
	Start voltage	OFF
	Voltage rise time	0.1 s
	Voltage fall time	OFF
	Output frequency	50 Hz

B Configuration Settings

The configuration settings are contained on the following screens of the Configuration Menu.

Configuration Menu	
1. Test Mode and Buzzer	Test mode and buzzer settings
2. Status Signal Output	Status signal output settings
3. Date and Time	Date, time, and calibration period settings
4. Communication	Time settings and calibration management
5. Information	Display of device information

★ Memo

The first screen that is displayed when you perform configuration settings is known as the Configuration Menu.

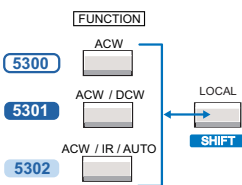
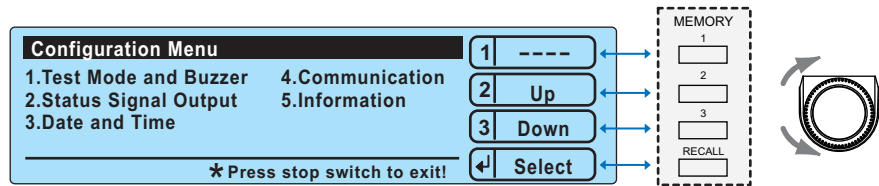

Press CONFIG (SHIFT+FUNCTION) to display the configuration setup screen (Configuration Menu).

On the Configuration Menu, press 2: Up (MEMORY 2) or 3: Down (MEMORY 3) to highlight the configuration item that you want to set, and then press Select (↵: RECALL) to select it.

On the configuration item's setup screen, press 2: Up (MEMORY 2) or 3: Down (MEMORY 3) or use the rotary knob to highlight the item that you want to set, press Select (↵: RECALL) to select it, and then use the rotary knob to set the value.

When a configuration item's setup screen is displayed, pressing SHIFT changes the operation of the MEMORY 1 and RECALL keys.

1 Back	SHIFT+1: Back	Displays the previous configuration item setup screen.
↵ Forward	SHIFT+↵: Forward	Displays the next configuration item setup screen.

To leave the configuration item setup screen and return to the Configuration Menu, press 1: Menu (MEMORY 1). To leave the Configuration Menu and return to the basic setup screen, press STOP.

If you perform configuration setup again without first turning the power off, the screen that you previously were viewing will be displayed.

Test Mode and Buzzer settings

You can set the following settings on the Test Mode and Buzzer screen.

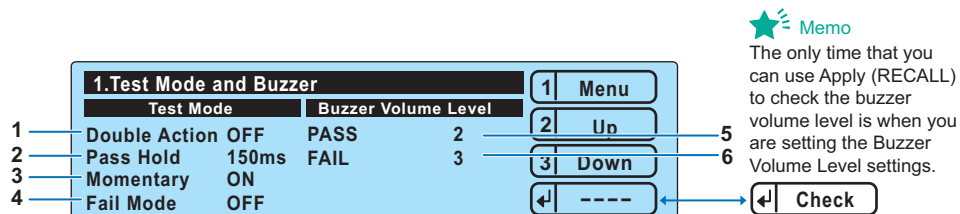

Item	Description	Panel operation
Test Mode		
1 Double Action	Sets the double action feature.	MEMORY 2 and MEMORY 3 keys
	ON Turns the double action feature on.	Rotary knob
	OFF Turns the double action feature off.	Rotary knob
2 Pass Hold	Sets the length of time that a PASS judgment result will be maintained.	MEMORY 2 and MEMORY 3 keys
	50 ms, 100 ms, 200 ms, 1s,2s,5s Setting	Rotary knob
	HOLD The results are maintained until you press STOP.	Rotary knob
3 Momentary	Sets the momentary feature.	MEMORY 2 and MEMORY 3 keys
	ON Turns the momentary feature on.	Rotary knob
	OFF Turns the momentary feature off.	Rotary knob
4 Fail Mode	Sets the fail mode.	MEMORY 2 and MEMORY 3 keys
	ON Turns the fail mode on.	Rotary knob
	OFF Turns the fail mode off.	Rotary knob
Buzzer Volume Level		
5 Pass	Sets the volume level of the buzzer that is sounded when a PASS judgment occurs.	MEMORY 2 and MEMORY 3 keys
	0 to 10 ¹ Setting	Rotary knob
6 Fail	Sets the volume level of the buzzer that is sounded when a FAIL judgment occurs.	MEMORY 2 and MEMORY 3 keys
	0 to 10 ¹ Setting	Rotary knob

1 After you set the value, you can use the Apply (RECALL) key to check the buzzer volume.

Status Signal Output settings

You can set the following settings on the Status Signal Output screen.

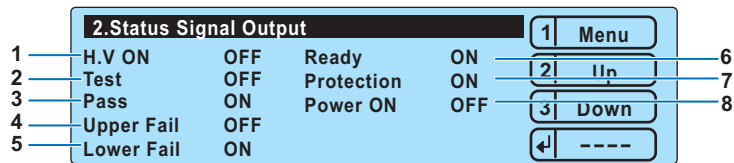

Item	Description	Panel operation
1 H.V ON	Sets whether the 24 VDC output is generated while there is a residual voltage and during tests.	MEMORY 2 and MEMORY 3 keys
	ON Turns the 24 VDC output on while there is a residual voltage and during tests.	Rotary knob
	OFF Turns the 24 VDC output off while there is a residual voltage and during tests.	
2 Test	Sets whether the 24 VDC output is generated while tests are being performed with the test voltage at the specified voltage value. ¹	MEMORY 2 and MEMORY 3 keys
	ON Turns the 24 VDC output on during testing.	Rotary knob
	OFF Turns the 24 VDC output off during testing.	
3 Pass	Sets whether the 24 VDC output is generated after a PASS judgment has occurred.	MEMORY 2 and MEMORY 3 keys
	ON Turns the 24 VDC output on after a PASS judgment has occurred.	Rotary knob
	OFF Turns the 24 VDC output off after a PASS judgment has occurred.	
4 Upper Fail	Sets whether the 24 VDC output is generated after an upper limit FAIL judgment has occurred.	MEMORY 2 and MEMORY 3 keys
	ON Turns the 24 VDC output on after an upper limit FAIL judgment has occurred.	Rotary knob
	OFF Turns the 24 VDC output off after an upper limit FAIL judgment has occurred.	
5 Lower Fail	Sets whether the 24 VDC output is generated after a lower limit FAIL judgment has occurred.	MEMORY 2 and MEMORY 3 keys
	ON Turns the 24 VDC output on after a lower limit FAIL judgment has occurred.	Rotary knob
	OFF Turns the 24 VDC output off after a lower limit FAIL judgment has occurred.	
6 Ready	Sets whether the 24 VDC output is generated while the READY LED is lit.	MEMORY 2 and MEMORY 3 keys
	ON Turns the 24 VDC output on while the READY LED is lit.	Rotary knob
	OFF Turns the 24 VDC output off while the READY LED is lit.	
7 Protection	Sets whether the 24 VDC output is generated while the TOS5300 Series is in the protection state.	MEMORY 2 and MEMORY 3 keys
	ON Turns the 24 VDC output on when the TOS5300 Series enters the protection state.	Rotary knob
	OFF Turns the 24 VDC output off when the TOS5300 Series enters the protection state.	
8 Power ON	Sets whether the 24 VDC output is generated while the POWER switch is on.	MEMORY 2 and MEMORY 3 keys
	ON Turns the 24 VDC output on when the POWER switch is turned on.	Rotary knob
	OFF Turns the 24 VDC output off when the POWER switch is turned on.	

1 The 24 VDC output is not generated during voltage rise time (Rise Time) and voltage fall time (Fall Time).

Date and Time settings

You can set the following settings on the Date and Time screen.

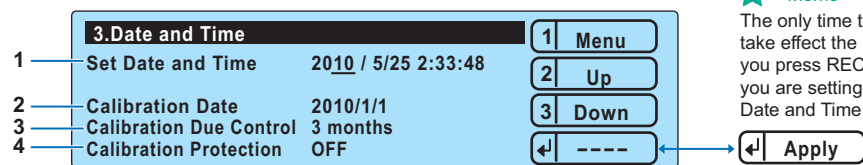

Item	Description	Panel operation
1 Set Date and Time	Sets the system clock. After you enter the current time, press Apply (RECALL) to apply the changes.	MEMORY 2 and MEMORY 3 keys
	Year/Month/Day Hour:Minute:Second Sets the current time.	MEMORY 2 and MEMORY 3 keys Rotary knob
2 Calibration Date	Displays the calibration date. Displays the date that was set during the last calibration service or the date that you calibrated the TOS5300.	See p.55
	3 Calibration Due Control	Sets the calibration period.
4 Calibration Protection	3 months to 36 months Sets the number of months.	MEMORY 2 and MEMORY 3 keys
	INF Infinity	Rotary knob
	ON When the calibration period elapses, the message "Calibration Protection (Code:0x0002)" will be displayed when you turn the TOS5300 Series on. While this message is displayed, you cannot use the TOS5300 Series. To continue using the TOS5300 Series, press STOP and then CONFIG (SHIFT+FUNCTION) to display the configuration setup screen. Next, select 3.Date and Time, and then set Calibration Protection to OFF.	MEMORY 2 and MEMORY 3 keys
OFF	When the calibration period elapses, the message "Calibration Protection (Code:0x0002)" will be displayed when you turn the TOS5300 Series on. If you press STOP, you can continue using the TOS5300 Series.	STOP switch CONFIG (SHIFT+FUNCTION) key MEMORY 2 and MEMORY 3 keys

Communication display items

The following items are displayed on the Communication screen. You cannot set these items.

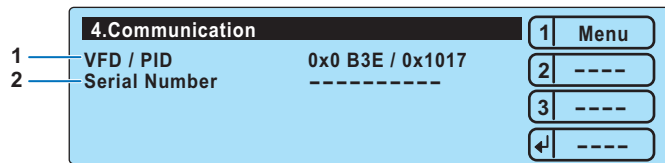

Item	Description	Panel operation
VFD / PID	Displays the vendor ID and product ID	—
Serial Number	Displays the serial number	—

Information display items

The following items are displayed on the Information screen. You cannot set these items.

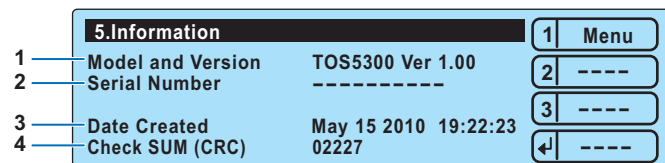

Item	Description	Panel operation
1 Model and Version	Displays the model name and firmware version	—
2 Serial Number	Displays the serial number	—
3 Date Created	Displays the date that the firmware was made	—
4 Check SUM (CRC)	Displays the firmware's check code	—

C Protective Features

If one or more of the causes of the following problems occur, the protective circuits will activate, and you will no longer be able to use the TOS5300 Series. This is referred to as PROTECTION mode.

When the TOS5300 Series switches to PROTECTION mode, a "PROTECTION" message is displayed on the screen. Follow the instructions below to remove the cause of the problem and clear the PROTECTION mode.

If the TOS5300 Series has switched to PROTECTION mode because of multiple causes, the PROTECTION message that has highest priority is displayed with "..." to indicate that there are multiple causes. The code number indicates the sum of all the causes' code numbers.

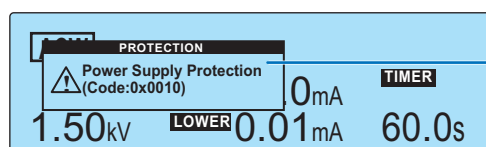

The cause that activated the protection feature and the code number are displayed.

Example: Detection of an input voltage problem

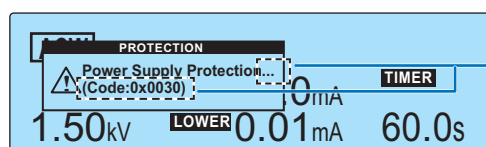

"..." is displayed after the PROTECTION message. The code number indicates the sum of all the causes' code numbers.

Example: Detection of multiple causes that made protection activate (An error was detected in the power supply and an output voltage outside of the rated limits was detected.)

Priority	Displayed message	Code no.	Description	Corrective action
1	Interlock Protection	0x0001	An interlock signal was detected.	Remove the interlock signal input, and then press STOP.
2	Power Supply Protection	0x0010	An error was detected in the power supply.	You can clear the PROTECTION mode by pressing STOP, but if this message appears frequently, repairs are necessary.
3	Volt Error Protection	0x0020	An output voltage outside of the rated limits was detected. AC or DC withstanding voltage tests: ± 350 V Insulation resistance test: $\pm(10\%$ of setting 10 V)	Press STOP.
4	Over Load Protection ¹	0x0100	The output power exceeded the output limit power. AC withstanding voltage tests: 550 VA DC withstanding voltage tests: 55 VA	Press STOP.
5	Over Heat Protection	0x0200	The internal temperature of the TOS5300 Series became too high.	Confirm that the internal temperature of the TOS5300 Series has decreased, and then press STOP.
6	Over Rating Protection ¹	0x0400	The output current was generated for a length of time that exceeds the regulated time.	Press STOP.
7	Calibration Protection	0x0002	The calibration period specified by Calibration Due Control on the Configuration Menu's 3.Date and Time screen has expired.	If this setting is set to ON, press STOP, and then set Calibration Protection to OFF on the Configuration Menu's 3.Date and Time screen. If this setting is set to OFF, press STOP.
8	Remote Protection	0x1000	A connection to or disconnection from the REMOTE connector was detected.	Check the REMOTE connector, and then press STOP.
9	SIGNAL I/O Protection	0x2000	The SIGNAL I/O connector's ENABLE signal has changed.	Press STOP.
10	USB Protection	0x4000	The USB connector has been disconnected, or a defect was detected while the TOS5300 Series was being controlled through the USB interface.	Check the USB connector, and then press STOP.

¹ Only during withstanding voltage tests

D Timing chart

PASS judgment

AC withstanding voltage test (ACW)

■ Setting conditions

Model: TOS5302
Voltage rise time (Rise Time) : 100 ms
Test time (Test Time) : 100 ms
Voltage fall time (Fall Time) : 0 ms
Frequency : 50 Hz
Start at SIGNAL I/O (Low-active control input).

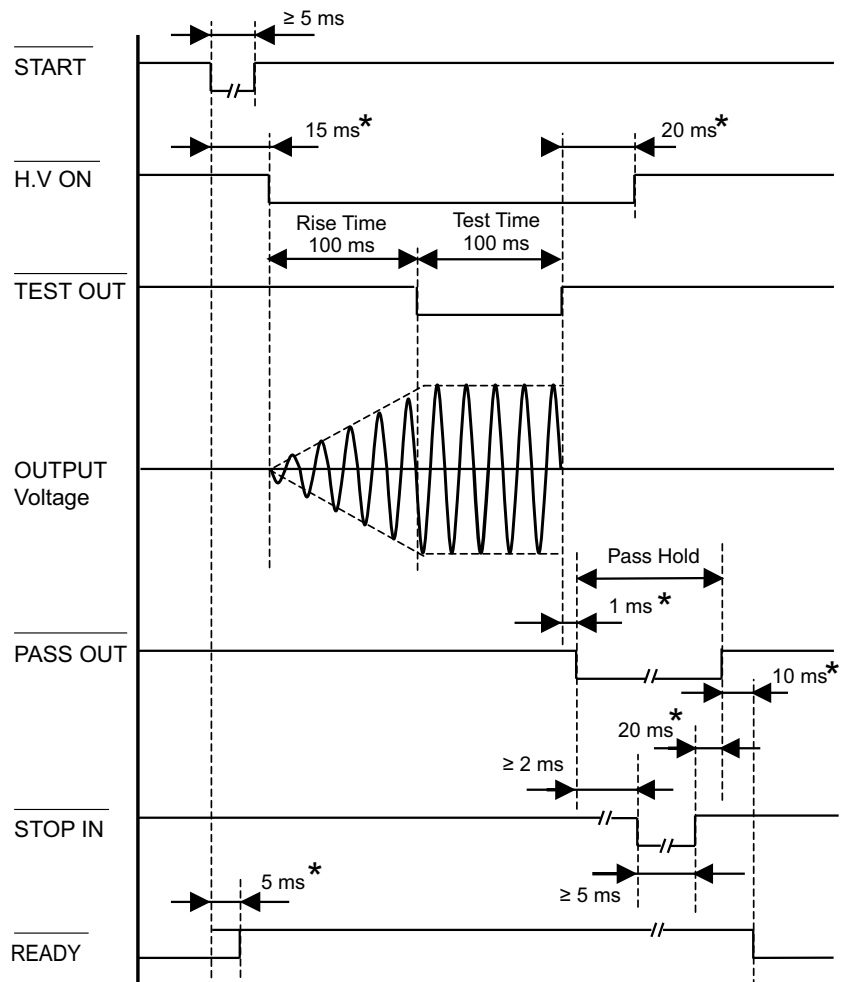

* Typical value

DC withstanding voltage test (DCW)

■ Setting conditions

Model: TOS5302
 Voltage rise time (Rise Time) : 100 ms
 Test time (Test Time) : 100 ms
 Judgment wait time (Wait Time): 100 ms
 Start at SIGNAL I/O (Low-active control input).

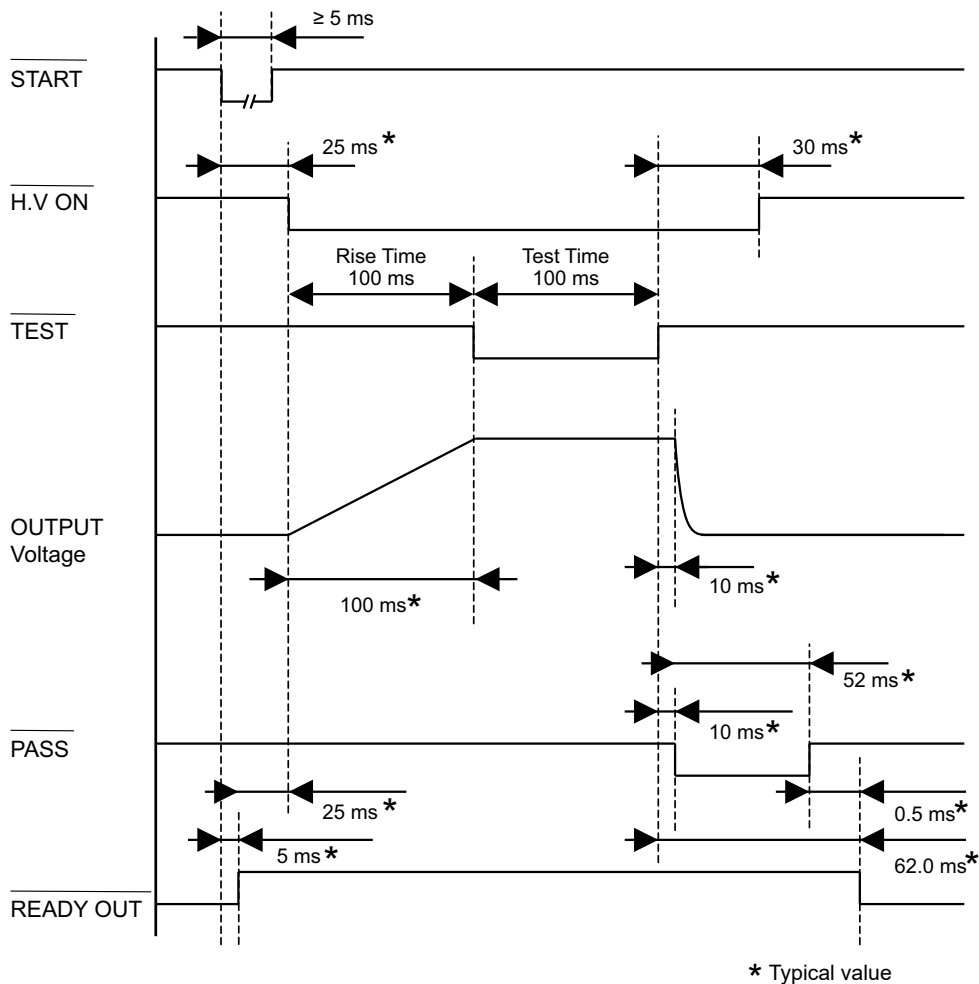

Insulation resistance test (IR)

■ Setting conditions

Model: TOS5302

Test time (Test Time): 100 ms

Start at SIGNAL I/O (Low-active control input).

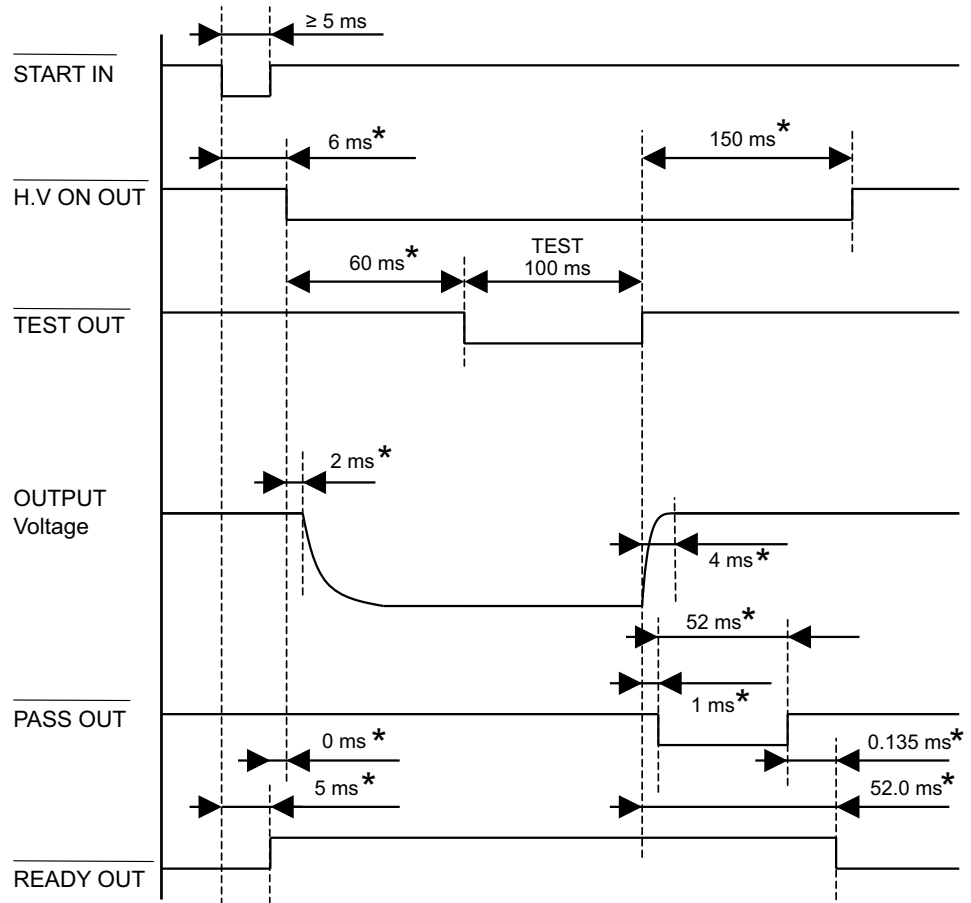

* Typical value

Auto Test (AUTO) [Insulation resistance test (IR)→AC withstanding voltage test (ACW)]

■ Setting conditions

Model: TOS5302

IR Test time (Test Time) : 100 ms

ACW Voltage rise time (Rise Time) : 100 ms

Test time (Test Time) : 100 ms

Voltage fall time (Fall Time) : 0 ms

Frequency : 50 Hz

Start at SIGNAL I/O (Low-active control input).

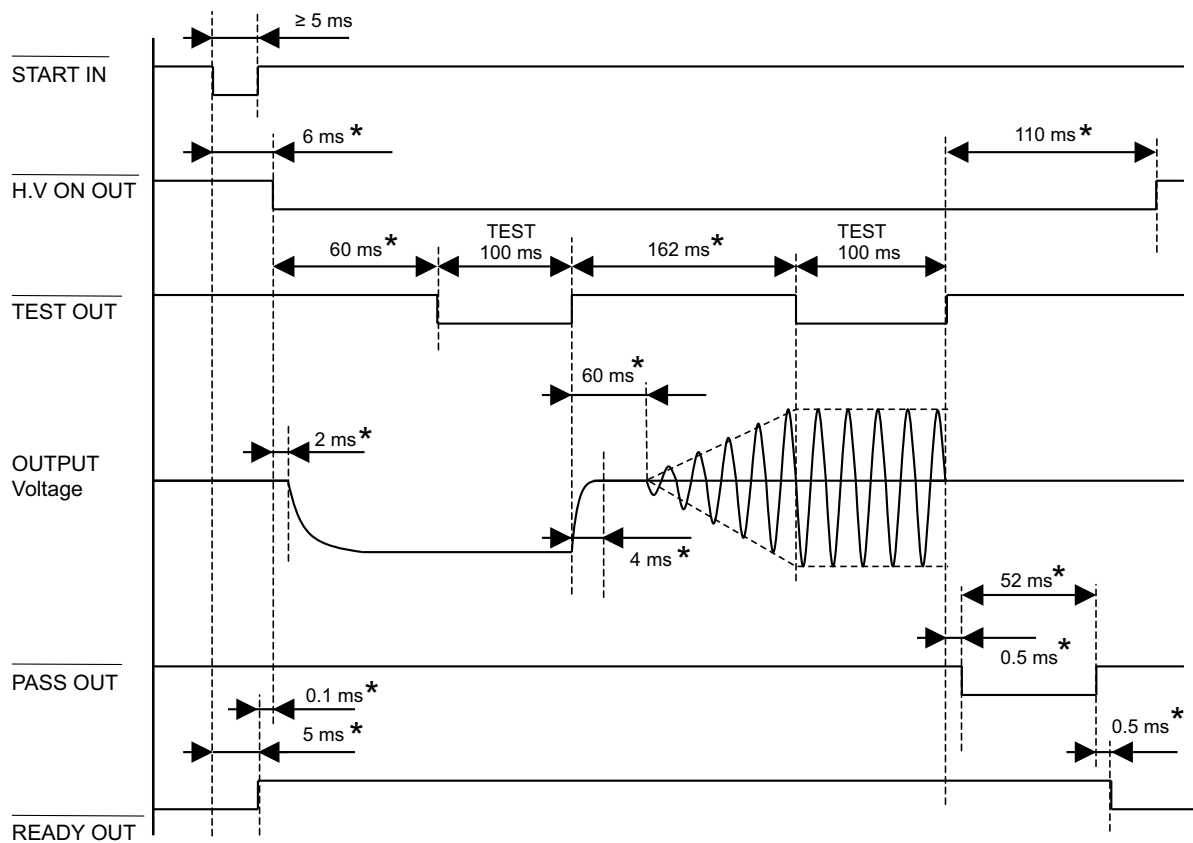

* Typical value

Auto Test (AUTO)
[AC withstanding voltage test (ACW) → Insulation resistance test (IR)]

■ **Setting conditions**

Model: TOS5302
 ACW Voltage rise time (Rise Time) : 100 ms
 Test time (Test Time) : 100 ms
 Voltage fall time (Fall Time) : 0 ms
 Frequency : 50 Hz
 IR Test time (Test Time) : 100 ms
 Start at SIGNAL I/O (Low-active control input).

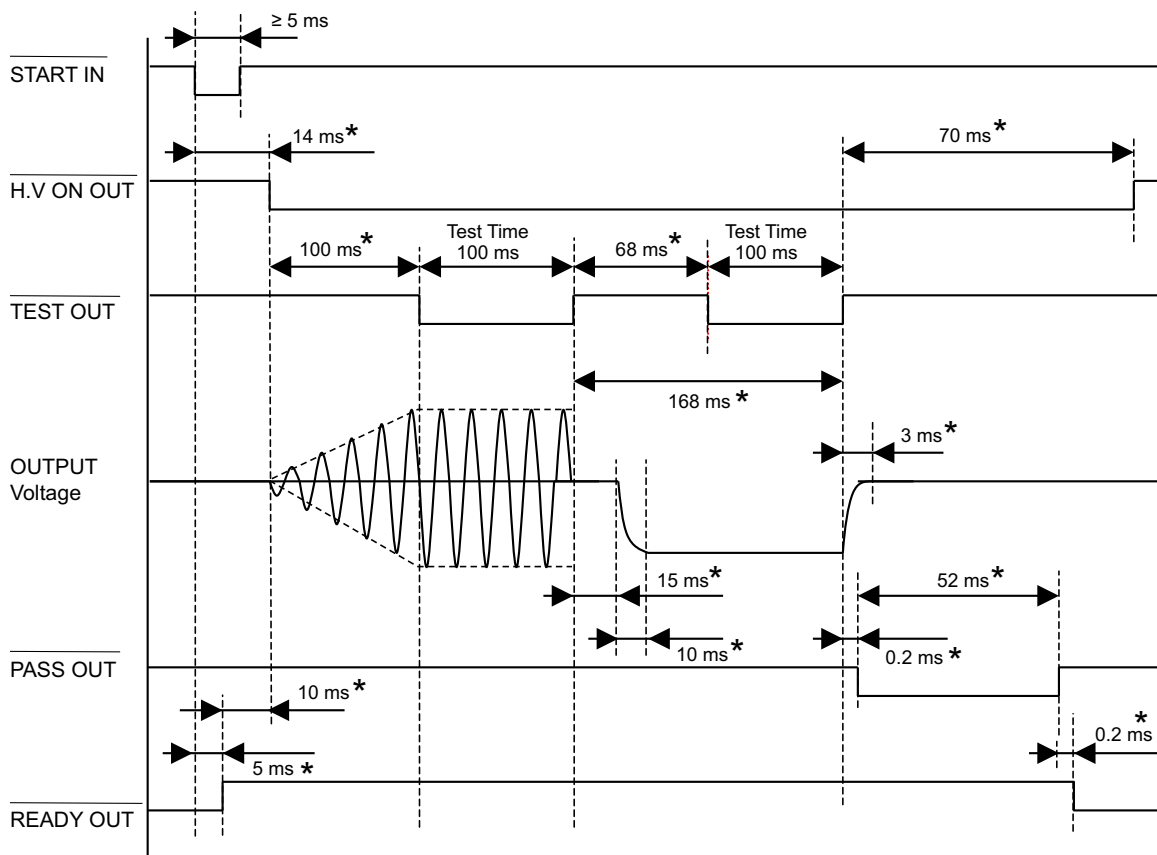

* Typical value

FAIL judgment

AC withstanding voltage test (ACW)

■ Setting conditions

Model: TOS5302
 Voltage rise time (Rise Time) : 100 ms
 Test time (Test Time) : OFF
 Frequency : 50 Hz
 Start at SIGNAL I/O (Low-active control input).

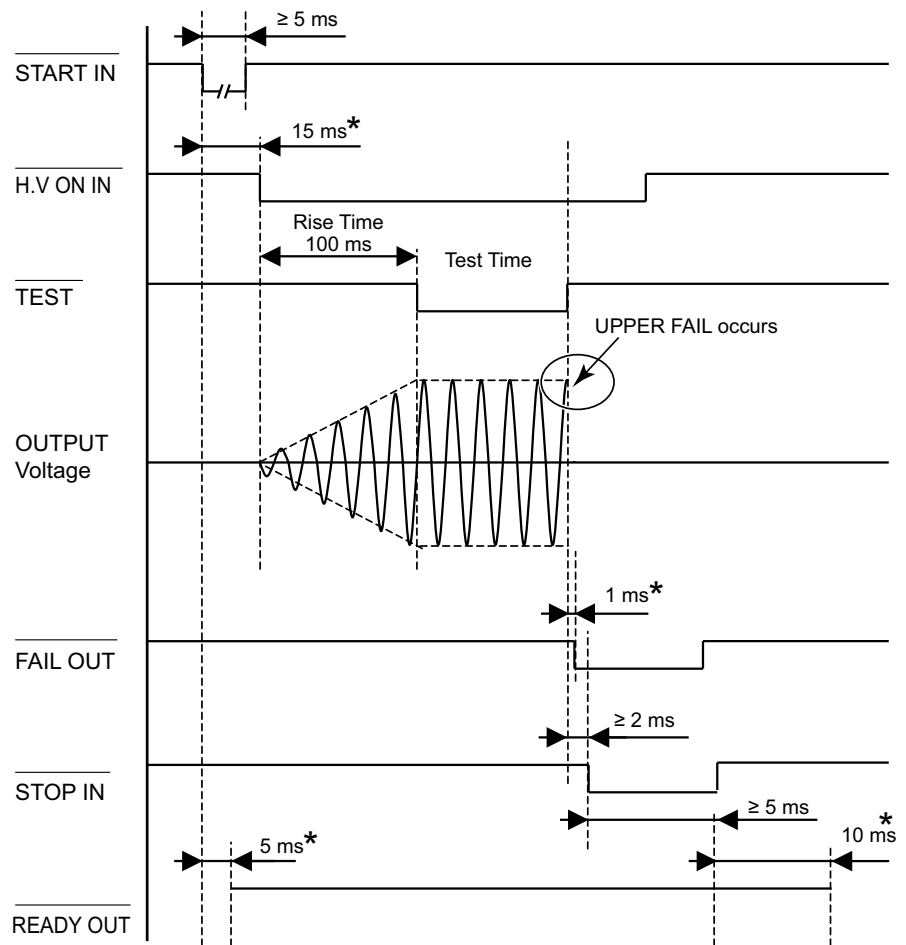

* Typical value

Takt time

■ Setting conditions

Model: TOS5300
 Voltage rise time (Rise Time) : 100 ms
 Test time (Test Time) : 100 ms
 Voltage fall time (Fall Time) : 0 ms
 Frequency : 50 Hz
 Start at SIGNAL I/O (Low-active control input).

NOTE

This is the minimum takt time for test currents less than equal to 50 mA. If the test current is greater than 50 mA, set an interval time that is at least twice as long as [Rise time + Test time].

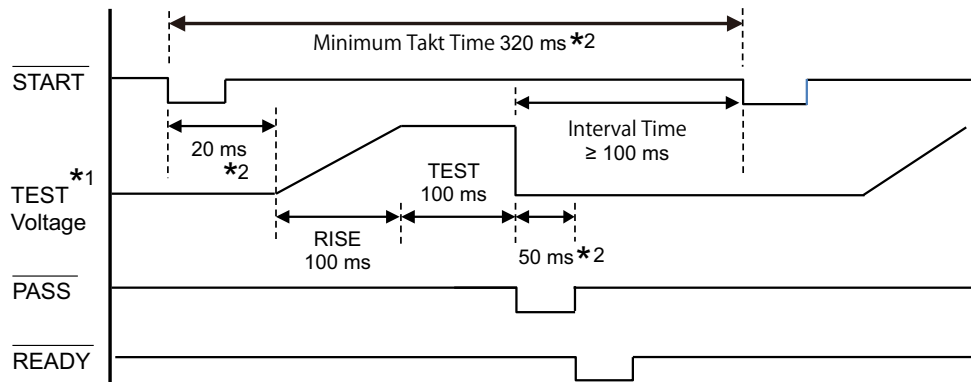

*1. For simplicity, only the positive test voltage is indicated with an envelope curve.
 *2. Reference value

E Troubleshooting

This section introduces troubleshooting measures. Typical symptoms are listed. Check whether any of the items listed below apply to your case. In some cases, the problem can be solved quite easily.



 p.86

If none of the items apply to your case, we recommend that you initialize the TOS5300 Series to its factory default settings. If the remedy does not correct the problem, Contact your Kikusui agent or distributor.

The power does not turn on

Symptom	Items to check and possible remedy	
The TOS5300 Series does not operate when the POWER switch is turned on.	Is the power cord disconnected?	p.21
	Has the interlock feature been activated?	p.23
	Release the interlock feature.	p.69

Unable to carry out panel operations

Symptom	Items to check and possible remedy	
Testing does not begin when the START switch is pressed.	Is a probe connected to the REMOTE connector? When a probe is connected, only the probe's START switch is enabled.	p.28
	Is a STOP signal being applied to the SIGNAL I/O connector? When you are using the SIGNAL I/O connector to control the TOS5300 Series, the START switch on the panel is disabled.	p.67
	Is the TEST LED blinking? The TOS5300 Series is in the middle of the voltage rise time. The test will begin when the rise time elapses.	p.58
	Is "PROTECTION" message displayed on the screen? The TOS5300 Series is in PROTECTION mode. See "Protective Features."	p.93
	Is the double action feature on? Press STOP, and then press START within 0.5 seconds of pressing STOP. Alternatively, turn the double action feature off.	p.56
	You cannot start tests while panel memory is being accessed.	p.42
	Is a message displayed in the level bar area? A setting is invalid. Specify settings that are within the correct range.	p.46
	Panel operations are not being registered.	Is "KEY LOCK  " displayed (or blinking) in the upper right of the screen? Release the key lock.
Is the USB icon () displayed? The USB interface is in use. To control the TOS5300 Series from the panel, press the LOCAL key to switch to local mode.		—
The TOS5300 Series does not switch to local mode even when the LOCAL key is pressed.	Was a local lockout (LLO) command sent through the communication interface? Use a communication command to clear LLO command.	—

App

Unable to perform measurements

Symptom	Items to check and possible remedy	 See
The measured values are abnormal.	Are the test leads connected to the correct terminals? Connect the test leads properly.	p.26
Judgments do not begin.	Has the judgment wait time been set? Judgments will not begin until the specified judgment wait time elapses. Set an appropriate judgment wait time.	p.53
Testing does not finish.	Is the timer turned off? The specified test time has not been enabled. Turn the timer on.	p.46 p.47 p.48 p.49
The time when test data was saved is incorrect.	Is the system clock correct? Set the system clock to match the current time.	p.73

Index

A	
accessories	20
ACW	36, 47
AUTO	36
auto test	50
B	
backup lithium battery	74
Buzzer Volume	57
C	
Calibration Date	91
Calibration Due Control	91
calibration period	73
Calibration Protection	73, 91, 93
Check SUM (CRC)	92
Communication	92
configuration setup screen	88
connecting	
DUT	26
D	
Date and Time	91
Date Created	92
DCW	36, 48
default settings, list	86
dimensions	84
Double Action	56, 89
DUT	26
F	
Fail	89
Fail Mode	57, 89
Fall time control	52
Frequency	52
H	
HP01A-TOS	28
HP02A-TOS	28
I	
Information	92
initializing	86
inspection	72
judgment feature	72
test leads	72
Interlock Protection	93
IR	36, 49
J	
judgment	46
judgment wait time	53
K	
KEY LOCK	40
key lock	40
L	
L-FAIL	46
Lower Fail	90
M	
measurement check	72
Model and Version	92
Momentary	57, 89
O	
options	16
Over Heat Protection	93
Over Load Protection	93
Over Rating Protection	93
P	
panel memory	43, 87
PASS	46
Pass	89, 90
Pass Hold	56, 89
power cord	21
Power ON	90
Power Supply Protection	93
power, turning on	23
Protection	90
protection mode	93
R	
rack mount adapter	16
Ready	90
Remote Protection	93
Response	52
Rise time control	52
ROM version	2

S

saving	43
Serial Number	92
Set Date and Time	91
setup screen	
AC withstanding voltage test	38, 47
DC withstanding voltage test	38, 48
insulation resistance test	38, 49
SIGNAL I/O connector	64
SIGNAL I/O Protection	93
single test	41
Start Voltage	51
Status Signal Output	90
system clock	73, 91

T

TEST	90
Test Mode and Buzzer	89
test probe	17, 28
testing, finishing	61
testing, starting	58
troubleshooting	101

U

U-FAIL	46
Upper Fail	90
USB Protection	93

V

version	2
Volt Error Protection	93

W

Wait Time	53
warm-up time	76

If you find any misplaced or missing pages in the manuals, they will be replaced. If the manual gets lost or soiled, a new copy can be provided for a fee. In either case, please contact your Kikusui agent or distributor. At that time, inform your agent or distributor of the "Part No." written on the front cover of this manual.

Every effort has been made to ensure the accuracy of this manual. However, if you have any questions or find any errors or omissions, please contact your Kikusui agent or distributor.

After you have finished reading this manual, store it so that you can use it for reference at any time.

KIKUSUI ELECTRONICS CORP.

1-1-3 Higashiyamata, Tsuzuki-ku, Yokohama,
224-0023, Japan

Tel: +81-45-482-6353

Fax: +81-45-482-6261

www.kikusui.co.jp/en

