

Communication Interface Manual

Insulation Resistance Tester

TOS7200

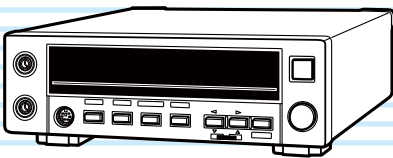

PID Insulation Tester

TOS7210S (SPEC80776)

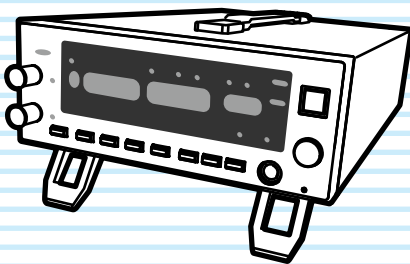

DANGER

This product generates high voltage!

- Improper operation can lead to serious accidents.
- To prevent accidents, be sure to read the section “Safety Precautions during Testing” in the user’s manual.

1. Remote Control

- Overview 3
- Connecting a cable 3
- Protocol 4
- Send and receive via the RS232C 4
- Switching to local mode 5

2. Messages and Terminator

- Program message 6
- Acknowledge message 7
- Terminator 7

3. Device Messages

- Register-Related and General Purpose Messages 9
- Test-Related Messages 14
- System-Related Messages 20
- Memory-Related Messages 23

4. Registers

- Structure of Status Data 26

5. List of Device Messages

- List of Register-Related and General Purpose Device Messages 29
- List of Device Messages Relating to Tests 30
- List of System-Related Device Messages 31
- List of Memory-Related Device Messages 32

Index 33

About the Operation Manuals

There are five TOS7200/ 7210S Manuals listed as follows.

- **Setup Guide**
Setup Guide is intended for first-time users of this product. It provides an overview of the product and notes on usage. It also explains how to set up the product for testing the DUT. Always read this manual before using the product.
- **Quick Reference**
Quick Reference explains Panel description and operation briefly.
- **Safety Information**
Safety information contains general safety precautions for this product. Keep them in mind and make sure to observe them.
- **User's Manual**
User's manual is intended for first-time users of this product. It provides an overview of the product and notes on usage. It also explains how to configure the product, operate the product, perform maintenance on the product, and so on.
- **Communication Interface Manual (This manual)**
Interface Manual contains details about remote control. The manual is provided on the accompanying CD-ROM.
Interface manual is written for readers with sufficient basic knowledge of how to control instruments using a personal computer.

TOS7200/ TOS7210S Manuals are intended for users of the PID InsulationTester and their instructors. Explanations are given under the presumption that the reader has knowledge about the electrical aspects of electrical safety testing.

Before reading this manual

First read the User's Manual, which includes information on the product's hardware, to avoid connecting or operating the product incorrectly.

Product firmware versions

This manual applies to products with ROM versions 1.0X.

For information on how to check the product's firmware version, see the user's manual.

Copyrights

The contents of this manual may not be reproduced, in whole or in part, without the prior consent of the copyright holder.

The specifications of this product and the contents of this manual are subject to change without prior notice.

©2014 Kikusui Electronics Corporation

Notations Used in This Manual

- Device under test is also referred to as DUT.
- The term "PC" is used to refer generally to both personal computers and workstations.
- The following markings are used in the explanations in the text.

WARNING

Indicates a potentially hazardous situation which, if ignored, could result in death or serious injury.

CAUTION

Indicates a potentially hazardous situation which, if ignored, may result in damage to the product or other property.

NOTE

Indicates information that you should know.

DESCRIPTION

Explanation of terminology or operation principle.

1 Remote Control

Overview

This chapter describes device messages and preparations for remotely controlling the TOS7200/ TOS7210S via the RS232C interface. Remote control can be used in an automated system to set various functions, acquire measured data, and so on.



WARNING The remote control uses an external signal to turn ON/OFF the high voltage, which may result in great danger in some cases. Therefore, thorough safety measures must be taken to ensure that high voltage is not generated accidentally and that no one touches the DUT, high-voltage test leadwire, high-voltage probe, output terminals, or the like while high voltage is being generated. If such measures cannot be taken, do not perform remote control.



NOTE Performing remote control through the RS232C interface causes the REMOTE LED to light up, notifying the operator that no input other than the STOP switch and the STOP signal of the SIGNAL I/O is accepted. To restore local control, press the LOCAL key.

Connecting a cable

- 1 Turn off the POWER switch on the tester and the POWER switch on the controller.
- 2 Connect an RS232C cross-cable to the 9-pin RS232C connector on the rear panel of the tester.

The pin configuration of the connector is as shown below.

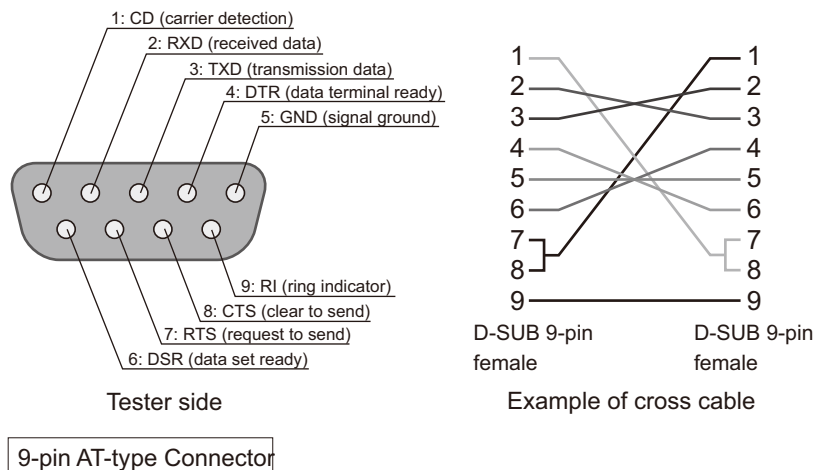

Protocol

The RS232C protocol allows only the communication rate to be selected. Other items are fixed.

■ RS232C Protocol

Item	Set value
Communication rate	9600/19200/38400 bps
Data length	8 bits
Parity bit	None
Stop bit	2 bits

■ Setting the communication rate

The communication rate is set after entering system setting. For details, see "System Settings" of chapter 4 "Basic Operation" on the user's manual.

1 With the SHIFT key held down, press the VOLT key to enter system mode.

This causes the leftmost digit (digit indicated as DOUBLE ACTION) of the voltmeter to blink, indicating that the cursor is positioned at this digit.

2 Press the ◀ or ▶ key to move the cursor to the SPEED position.

3 With the SHIFT key held down, press the ▼ or ▲ key to change the communication rate.

The communication rate can be selected from among 0: 9 600 bps; 1: 19 200 bps; and 2: 38 400 bps.

4 Press the STOP switch to exit system setting.

Send and receive via the RS232C

Sending and receiving via the RS232C interface should be controlled by flow control or the use of acknowledge messages. One-way transmission may fail to send and receive data properly. For details, see "Acknowledge message" (p.7)."

■ RS232C flow control

Performing Xon/Xoff control allows sending and receiving of the tester to be controlled. These control codes are executed by DC (device control) codes.

The DC code is as shown below.

Code	Function	ASCII code
DC1	Request to send	11h
DC3	Request to stop sending	13h

Control of transmission from the RS-232C terminal to the power-supply controller

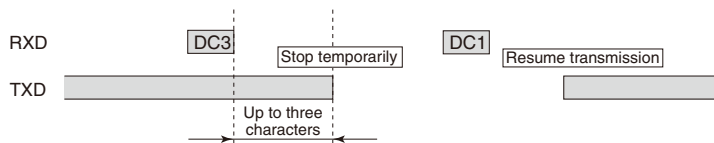

The tester temporarily stops transmission within three characters after receiving a DC3.

Control of transmission from the power-supply controller to the RS-232C terminal

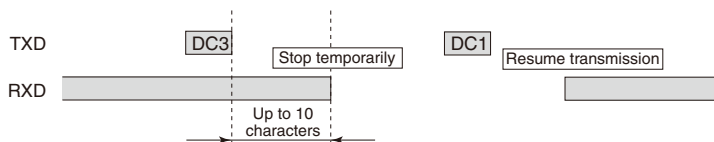

The RS-232C terminal must temporarily stop transmission within 10 characters after receiving a DC3.

Transmission Control between the RS232C Terminal and Tester

Switching to local mode

When the TOS7200/TOS7210S is being controlled remotely via RS232C, press LOCAL key on the front panel to return to local mode.

2 Messages and Terminator

This section specifies the designations and descriptions used in this manual for communications between a controller(PC) and the tester (device).

Commands sent from the controller to the tester are designated as program messages. Responses sent from the tester to the controller are designated as response messages.

Each message consists of the program header section and data section.

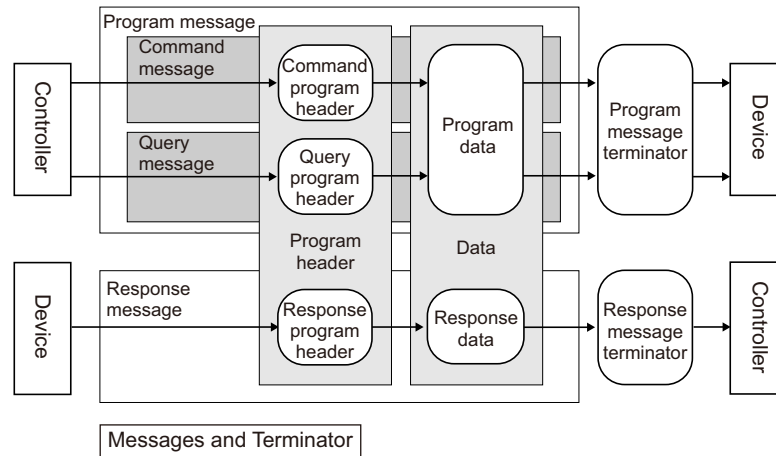

Program message

Program messages are further divided into a command message and a query message. A command message executes a specific function of the tester or modifies settings. A query message inquires of the setting or status of the tester.

Writing a program message

A space (ASCII: 20h) is required between the program header section and data section.

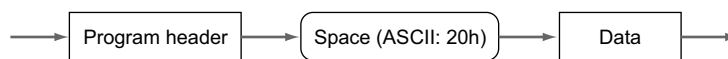

If there are multiple pieces of data, use commas (,) (ASCII: 2Ch) to link them.

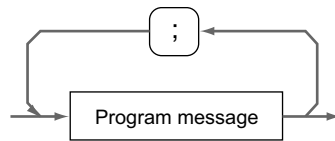

The concatenation of program messages is performed using a semicolon (;) (ASCII: 3Bh).

**NOTE**

When writing data using hexadecimal numbers, append "#H" to each piece of data.
Example: To write decimal number 10 in hexadecimal numbers, write "#H0A."

Acknowledge message

An acknowledge message is information sent from the tester to the controller. It informs the controller of the completion of processing of a program message.

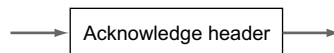

The acknowledge message is an ASCII-codye character string consisting of the header only. It can be of either of the following two types:

- OK: Normal end
- ERROR: Occurrence of an abnormality such as a syntax error, etc.

The SILENT command message can be used to set whether an acknowledge message is to be returned.

Terminator

A terminator indicating the end of a program message is designated as a program message terminator. A terminator indicating the end of a response message is designated as a response message terminator.

- Program message terminator

Either of the following two program message terminators may be used. This does not need to be preset.

CR、 CR+LF

- Response message terminator

Fixed to CR+LF

3 Device Messages

The program messages and response messages supported by this tester are designated as device messages.

This section describes each device message supported by the tester.

An item enclosed in parentheses next to a device message indicates the abbreviation of that device message.

Special symbols and characters

The special symbols and characters used in this manual to describe a program message or response message are defined as shown in the table below.

Symbol and character	Description
<>	These brackets indicate program data. Do not use them in actual programs.
{ }	Characters or numbers enclosed in these brackets and separated by “ ” indicate that one in brackets should be selected. In actual programs, do not use the brackets.
_	This character indicates a space.

Register-Related and General Purpose Messages

This subsection describes the device messages used to set, reset, or inquire about each register, and the general purpose device messages used to specify a terminator or other element.

*CLS

Resets the status byte register, event status register, device status register, fail register, invalid setting register, and error register ([p.26](#)).

Program message

- **Syntax**

Comand message: *CLS

*ESR

Inquires about the contents of the event status register ([p.27](#)). The event status register is reset when it is read by the *ESR? message.

Program message

- **Syntax**

Query message: *ESR?

Response message

Returns the contents of the event status register in response to *ESR? and resets the register.

(Example) When bit 5 of the event status register has been set, 32 is returned.

*IDN

Inquires about the model number and firmware version of the tester.

Program message

- **Syntax**

Query message: *IDN?

Response message

Returns the model number of the tester as shown in the following example, in response to *IDN?.

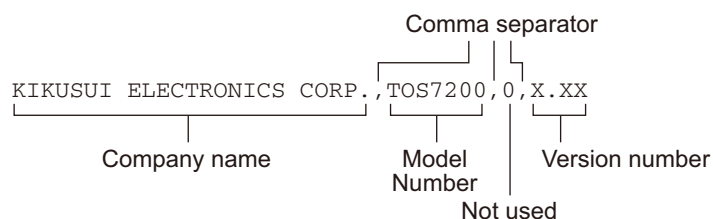

The model number is "7210S" for the TOS7210S.

*RST

Initializes the tester (restores factory default settings). Note that the communication rate will not be initialized.

For initialization, see “Initialize.” of chapter 4 “Basic Operation” on the user’s manual.

Program message

- **Syntax**

Command message: *RST

*SRE

Sets or resets each bit of the service-request enable register, or inquires about the contents of the register (p.27).

Program message

- **Syntax**

Command message: *SRE_<value>

This command message will be disabled during a test or while a PASS or FAIL judgment is being made.

Query message: *SRE?

- **Program data**

Data format: Hexadecimal or decimal numbers

Set value: 00H to FFH (0 to 255)

Resolution: 1H (1)

(Example) To set the service-request enable register to #50H,

*SRE #H50

Response message

Returns the contents of the service-request enable register in response to *SRE?

(Example) When bits 5 and 6 of the service-request enable register are set, 96 is returned.

*STB

Inquires about the contents of the status byte register (p.27).

Program message

- **Syntax**

Query message: *STB?

Response message

Returns the contents of the status byte register in response to *STB?

(Example) When bits 5 and 6 of the status byte register are set, 96 is returned.

CLR

Resets all registers (not including the enable register) to set the STOP flag.
This device message is also used to perform the same processing as DCL from the RS232C interface.

Program message

- **Syntax**
Command message: CLR

DSE

Sets or resets each bit of the device-status enable register (p.27). Also inquires about the contents of that register.

Program message

- **Syntax**
Command message: DSE_<value>
This command message will be disabled during a test or while a PASS or FAIL judgment is being made.
Query message: DSE?

- **Program data**
Data format: Hexadecimal or decimal numbers
Set value: 00H to FFH (0 to 255)
Resolution: 1H (1)

(Example) To set the device-status enable register to 01H,
DSE #H01

Response message

Returns the contents of the device-status enable register in response to DSE?
(Example) When bit 5 of the device-status enable register is set,
32 is returned.

DSR

Inquires about the contents of the device status register (p.27).

Program message

- **Syntax**
Query message: DSR?

Response message

Returns the contents of the device status register in response to DSR?
(Example) When bit 5 of the device status register is set,
32 is returned.

ERR

Inquires about the contents of the error register (p.28).

The error register will be reset when read by the ERR? message.

Program message

- **Syntax**

Query message: ERR?

Response message

Returns the contents of the error register in response to ERR?, and resets the register.

(Example) When bit 3 of the error register is set,
8 is returned.

FAIL

Inquires about the contents of the fail register (p.28).

Program message

- **Syntax**

Query message: FAIL?

Response message

Returns the contents of the fail register in response to FAIL?

(Example) When bit 4 of the fail register is set,
16 is returned.

INVALID (INV)

Inquires about the contents of the invalid register (p.28).

Program message

- **Syntax**

Query message: INVALID?
INV?

Response message

Returns the contents of the invalid register in response to INV?

(Example) When bit 3 of the invalid register is set,
8 is returned.

SILENT (SIL)

Sets whether an acknowledge message is returned in response to a message delimited by the response-message terminator. Also inquires about the set value indicating whether an acknowledge message is returned by the SILENT? message.

The acknowledge message returns either "OK" or "ERROR." To receive the acknowledge message, the RS232C setting should be full duplex communications.

NOTE

Full duplex communications: A communications system capable of always flowing data in both directions in data transmission between two parties. For setting of full duplex communications, see the operating manual of the PC.

Program message

- **Syntax**

Command message: SILENT_<{0|1}>
SIL_<{0|1}>

Query message: SILENT?
SIL?

- **Program data**

Data format: Integer

Set value: 0: Returns an acknowledge message.
1: Does not return an acknowledge message.

(Example) To makes a setting such that no acknowledge message is returned,
SIL 1

Response message

Returns the set value of the acknowledge message in response to SIL?

(Example) When the current setting is "Does not to return the acknowledge message",
1 is returned.

START

Starts a test.

Program message

- **Syntax**

Command message: START

This command message will be disabled during a test or while a PASS or FAIL judgment is being made.

STOP

Stops a test, or cancels a FAIL judgment, a PASS judgment, or the PASS HOLD status.

Program message

- **Syntax**

Command message: STOP

Test-Related Messages

This subsection describes the device messages used to set the test conditions or to check settings.

AUTORANGE (AUTOR)

Sets ON/OFF for auto-range or inquires about the current auto-range setting.

Program message

- **Syntax**

Command message: `AUTORANGE_<{ON|OFF|1|0}>`
`AUTOR_<{ON|OFF|1|0}>`

This command message will be disabled during a test or while a PASS or FAIL judgment is being made.

Query message: `AUTORANGE?`
`AUTOR?`

- **Program data**

Data format: Character (integer)

Set value: OFF (0): Auto-range OFF (The fixed range applies.)
 ON (1) : Auto-range ON

(Example) To make settings so that measurement is made in auto-range,
`AUTOR ON`

Response message

Returns the current setting in response to `AUTOR?`

(Example) When the current setting is auto-range,
 1 is returned.

LOWER (LOW)

Sets the lower resistance (LOWER) and ON/OFF for lower judgment. Also inquires about the current lower resistance and the setting for lower judgment.

NOTE

FAIL judgments are not made when the lower judgment and upper judgment functions are set to OFF. In this situation, if the timer is set to ON, a PASS judgment will be made, so you need to be careful.

Program message

- **Syntax**

Command message: `LOWER_<lower resistance>, {ON|OFF|1|0}>`
`LOW_<lower resistance>, {ON|OFF|1|0}>`

This command message will be disabled during a test or while a PASS or FAIL judgment is being made.

Query message: `LOWER?`
`LOW?`

- **Program data <lower resistance>**

Data format: Real number
 Set value: 0.01E6 to 5 000E6
 Resolution: 0.01E6 (0.01E6 to 9.99E6)
 0.1E6 (10.0E6 to 99.9E6)
 1E6 (100E6 to 5 000E6)
 unit: Ω

- **Program data** <{ON|OFF|1|0}>

Data format: Character (integer)
 Set value: OFF (0): Lower judgment OFF
 ON (1) : Lower judgment ON

(Example) To set the lower resistance to 999 MW,
 LOW 999E6,1

Response message

Returns the current lower resistance and ON/OFF for the lower judgment in response to LOW?

(Example) When the current lower resistance is 100 M Ω and the lower judgment is OFF,
 100E6,0 is returned.

MON

Inquires about the current monitored values.

Program message

- **Syntax**

Query message: MON?

Response message

Returns the current monitored values in the form of “monitored voltage, monitored resistance, monitored current (TOS7210S only), elapsed (remaining) time” in response to MON?. Returns the previous test results if a test is not in progress.

(Example) When the monitored voltage is 500 V, the monitored resistance is 500 M Ω , the monitored current is 1 000 μ A, and the remaining time is 2.6 s,
 500,500E6,1000E6,2.6 is returned.

RDATA (RDAT)

Inquires about a monitored resistance value.

Returns the measured value during a test, and returns the previous resistance value after the test.

Program message

- **Syntax**

Query message: RDATA?
 RDAT?

Response message

Returns the monitored resistance value in response to RDAT?

(Example) When the current monitored resistance is 10 M Ω ,
 10.0E6 is returned.

IDATA (IDAT) (TOS7210S only)

Inquires about a monitored current value.

Returns the measured value during a test, and returns the previous resistance value after the test.

Program message

- **Syntax**

Query message: IDATA?
TDAT?

Response message

Returns the monitored current value in response to IDAT?

(Example) When the current monitored current is 1000 μ A,
1000E6 is returned.

TIMER

Sets the test duration (TEST TIME) and ON/OFF for the timer function. Also inquires about the current test time and the setting of the timer function.

Program message

- **Syntax**

Command message: TIMER_<test time>, {ON|OFF|1|0}>

This command message will be disabled during a test or while a PASS or FAIL judgment is being made.

Query message: TIMER?

- **Program data <test time>**

Data format: Real number

Set value: 0.5 to 999

Resolution: 0.5 to 99.9: 0.1
100 ~ 999: 1

unit: s

- **Program data <{ON|OFF|1|0}>**

Data format: Character (integer)

Set value: OFF (0): Timer function OFF
ON (1): Timer function ON

(Example) To set the test time to 5 s,
TIMER 5,ON

Response message

Returns the current test time and ON/OFF for the timer function in response to TIMER?

(Example) When the current test time is 2 s and the timer function is disabled,
2.0,0 is returned.

TESTV (TES)

Sets the test voltage. Also inquires about the current test voltage.

Program message

- **Syntax**

Command message: TESTV_<voltage value>
TES_<voltage value>

This command message will be disabled during a test or while a PASS or FAIL judgment is being made.

Query message: TESTV?
TES?

- **Program data**

Data format: Integer

Set value: TOS7200: 10 to 1020
TOS7210S: 10 to 2040

Resolution: 1

unit: V

(Example) To set the test voltage to 500 V,
TES 500

Response message

Returns the current test voltage in response to TES?

(Example) When the current test voltage is 250 V,
250 is returned.

POLARITY(POL) (TOS7210S only)

Sets the test voltage polarity, also inquire the present test voltage polarity.

Program message

- **Syntax**

Command message: POLARITY_{1|0}
POL_{1|0}

This command message will be disabled during a test or while a PASS or FAIL judgment is being made.

Query message: POLARITY?
POL?

- **Program data<{1|0}>**

Data format: Character (integer)

Set value: 0: A terminal - (negative)
1: A terminal + (positive)

Response message

Returns the current test voltage polarity in response to POL?

(Example) When the current A terminal polarity is negative
0 is returned.

TIME

Inquires about the elapsed time (time remaining when the timer function is activated) of testing.

Program message

- **Syntax**

Query message: TIME?

Response message

Returns the elapsed time (time remaining when the timer function is enabled) in response to TIME?.

(Example) When the current elapsed time (or remaining time) is 7.0 s and a test is underway,
7.0 is returned.

UPPER (UPP)

Sets the upper resistance and ON/OFF for the upper judgment. Also inquires about the current upper resistance and the setting for upper judgment.

Program message

- **Syntax**

Command message: UPPER_ <upper resistance, {ON|OFF|1|0}>
 UPP_ <upper resistance, {ON|OFF|1|0}>

This command message will be disabled during a test or while a PASS or FAIL judgment is being made.

Query message: UPPER?
 UPP?

- **Program data <upper resistance>**

Data format: Real number

Set value: 0.01E6 to 5 000E6

Resolution: 0.01E6 (0.01E6 to 9.99E6)
 0.1E6 (10.0E6 to 99.9E6)
 1E6 (100E6 to 5 000E6)

unit: Ω

- **Program data<{ON|OFF|1|0}>**

Data format: Character (integer)

Set value: OFF (0): Upper judgment OFF
 ON (1) : Upper judgment ON

(Example) To set the upper resistance to 100 MΩ,
 UPP 100E6,1

Response message

Returns the current upper resistance and ON/OFF for upper judgment in response to UPP?

(Example) When the current upper resistance is 500 MΩ and upper judgment is inactivated,
500E6,0 is returned.

VDATA (VDAT)

Inquires about the monitored voltage value for a test. Returns a real-time voltage value during the test, and returns the previous test voltage after the test.

Program message

- **Syntax**

Query message: VDATA?
 VDAT?

Response message

Returns the monitored voltage in response to VDAT?

(Example) When the current monitored voltage value is 500 V,
500 is returned.

WAITTIME (WTIM)

Sets the wait time (WAIT TIME) during a test. Also inquires about the value set for current wait time.

Program message

- **Syntax**

Command message: WAITTIME_<wait time>
 WTIM_<wait time>

This command message will be disabled during a test or while a PASS or FAIL judgment is being made.

Query message: WAITTIME?
 WTIM?

- **Program data**

Data format: Real number

Set value: 0.3 to 10.0

Resolution: 0.1

unit: s

(Example) To set the wait time to 1 s,
WTIM 1

Response message

Returns the current wait time in response to WTIM?

(Example) When the current wait time is 2.0 s,
2.0 is returned.

System-Related Messages

This subsection explains the device messages for items to be set on the System screen.

PASSHOLD (PHOL)

Sets ON/OFF for the pass hold for a PASS judgment. Also inquires about the current setting for pass hold.

Program message

- **Syntax**

Command message: `PASSHOLD_<{ON|OFF|1|0}>`
`PHOL_<{ON|OFF|1|0}>`

This command message will be disabled during a test or while a PASS or FAIL judgment is being made.

Query message: `PASSHOLD?`
`PHOL?`

- **Program data**

Data format: Character (integer)

Set value: OFF (0): Pass hold OFF
 ON (1) : Pass hold ON

(Example) To set pass hold to ON,
`PHOL ON`

Response message

Returns the current pass hold in response to PHOL?

(Example) When the current pass hold is OFF,
 0 is returned.

BUZZERVOL (BVOL)

Sets the buzzer volume. Also inquires about the current buzzer volume.

Program message

- **Syntax**

Command message: `BUZZERVOL_<set value>`
`BVOL_<set value>`

This command message will be disabled during a test or while a PASS or FAIL judgment is being made.

Query message: `BUZZERVOL?`
`BVOL?`

- **Program data**

Data format: Integer

Set value: 0 to 9

Resolution: 1

(Example) To set the buzzer volume to 5,
`BVOL 5`

Response message

Returns the current buzzer volume in response to BVOL?.

(Example) When the current buzzer volume is 3,
3 is returned.

MOMENTARY (MOM)

Sets the momentary (MOMENTARY). Also inquires about the current setting for momentary.

NOTE

The momentary function is useful in operating the tester from the front panel (or locally). For remote control of the tester via the RS232C interface, the ON/OFF settings for momentary have no effect.

Program message

- **Syntax**

Command message: MOMENTARY_<{ON|OFF|1|0}>
MOM_<{ON|OFF|1|0}>

This command message will be disabled during a test or while a PASS or FAIL judgment is being made.

Query message: MOMENTARY?
MOM?

- **Program data**

Data format: Character (integer)

Set value: OFF (0): Momentary OFF
ON (1): Momentary ON

(Example) To set the momentary to OFF,
MOM OFF

Response message

Returns the current momentary setting in response to MOM?

(Example) When the current momentary is ON,
1 is returned.

FAILMODE (FMOD)

Sets the fail mode (FAIL MODE). Also inquires about the current setting for fail mode.

Program message

- **Syntax**

Command message: FAILMODE_<{ON|OFF|1|0}>
FMOD_<{ON|OFF|1|0}>

This command message will be disabled during a test or while a PASS or FAIL judgment is being made.

Query message: FAILMODE?
FMOD?

- **Program data**

Data format: Character (integer)

Set value: OFF (0): Fail mode OFF
ON (1) : Fail mode ON

(Example) To set fail mode to OFF,
FMOD OFF

Response message

Returns the current fail mode setting in response to FMOD?

(Example) When the current fail mode is ON,
1 is returned.

DOUBLEACTION (DAC)

Sets the double-action mode (DOUBLE ACTION). Also inquires about the current setting for double-action mode.

NOTE

The double-action mode is useful in operating the tester from the front panel (locally). For remote control of the tester via the RS232C interface, the ON/OFF settings for double-action mode have no effect.

Program message

- **Syntax**

Command message: DOUBLEACTION_<{ON|OFF|1|0}>
DAC_<{ON|OFF|1|0}>

This command message will be disabled during a test or while a PASS or FAIL judgment is being made.

Query message: DOUBLEACTION?
DAC?

- **Program data**

Data format: Character (integer)

Set value: OFF (0): Double-action mode OFF
ON (1) :Double-action mode ON

(Example) To set the double-action mode to OFF,
DAC OFF

Response message

Returns the current setting for double-action mode in response to DAC?

(Example) When the current double-action mode is ON,
1 is returned.

Memory-Related Messages

This subsection describes the device messages to be used in relation to memory.

RECALL (REC)

Recalls stored panel settings from memory.

Program message

- **Syntax**

Command message: RECALL_<memory No.>
REC_<memory No.>

This command message will be disabled during a test or while a PASS or FAIL judgment is being made.

- **Program data**

Data format: Integer

Set value: 0 to 9

Resolution: 1

(Example) To recall a panel setting from memory number 9,
REC 9

STORE (STOR)

Stores the current panel settings.

Program message

- **Syntax**

Command message: STORE_<memory No.>
STOR_<memory No.>

This command message will be disabled during a test or while a PASS or FAIL judgment is being made.

- **Program data**

Data format: Integer

Set value: 0 to 9

Resolution: 1

(Example) To store the current panel settings for a tester in memory number 9,
STOR 9

MEMORY (MEM)

Stores the test conditions in a specified memory number (location). Also inquires about the contents of a specified memory number.

Program message

- **Syntax**

Command message: MEMORY (MEM) _<memory No., test voltage, lower resistance, upper resistance, test time, upper judgment {ON|OFF|1|0}, timer {ON|OFF|1|0}, wait time>

This command message will be disabled during a test or while a PASS or FAIL judgment is being made.

Query message: MEMORY? _<memory No.>
MEM? _<memory No.>

- **Program data <memory No.>**

Data format: Integer

Set value: 0 to 9

Resolution: 1

- **Program data <test voltage>**

Data format: Real number

Set value: TOS7200: 10 to 1020
TOS7210s: 10 to 2040

Resolution: 1

unit: V

- **Program data <lower resistance>**

Data format: Real number

Set value: 0.01E6 to 5 000E6

Resolution: 0.01E6 (0.01E6 to 9.99E6)
0.1E6 (10.0E6 to 99.9E6)
1E6 (100E6 to 5 000E6)

unit: Ω

- **Program data <upper resistance>**

Data format: Real number

Set value: 0.01E6 to 5 000E6

Resolution: 0.01E6 (0.01E6 to 9.99E6)
0.1E6 (10.0E6 to 99.9E6)
1E6 (100E6 to 5 000E6)

unit: Ω

- **Program data <test time>**

Data format: Real number

Set value: 0.5 to 999

Resolution: 0.1 (0.5 to 99.9)
1 (100 to 999)

unit: s

- **Program data <upper judgment {ON|OFF|1|0}>**

Data format: Character (integer)

Set value: OFF (0): Upper judgment OFF
ON (1) : Upper judgment ON

- **Program data <timer {ON|OFF|1|0}>**

Data format: Character (integer)

Set value: OFF (0): Timer OFF
ON (1) : Timer ON

- **Program data <wait time>**

Data format: Real number

Set value: 0.3 to 10.0

Resolution: 0.1

unit: s

Response message

Returns the contents of a specified memory number in response to MEM?_<memory number>.

The memory contents are returned in the same order as for the program message.

(Example) When the program message inquires about the contents of memory number 9 and the memory contents are test voltage: 50 V; lower resistance: 0.01 MW; upper resistance: 10.0 MW; test time: 2.0 s; upper judgment: OFF; timer: ON; and wait time: 0.5 s, 50,0.01E6,10.0E6,2.0,0,1,0.5 is returned.

4 Registers

Structure of Status Data

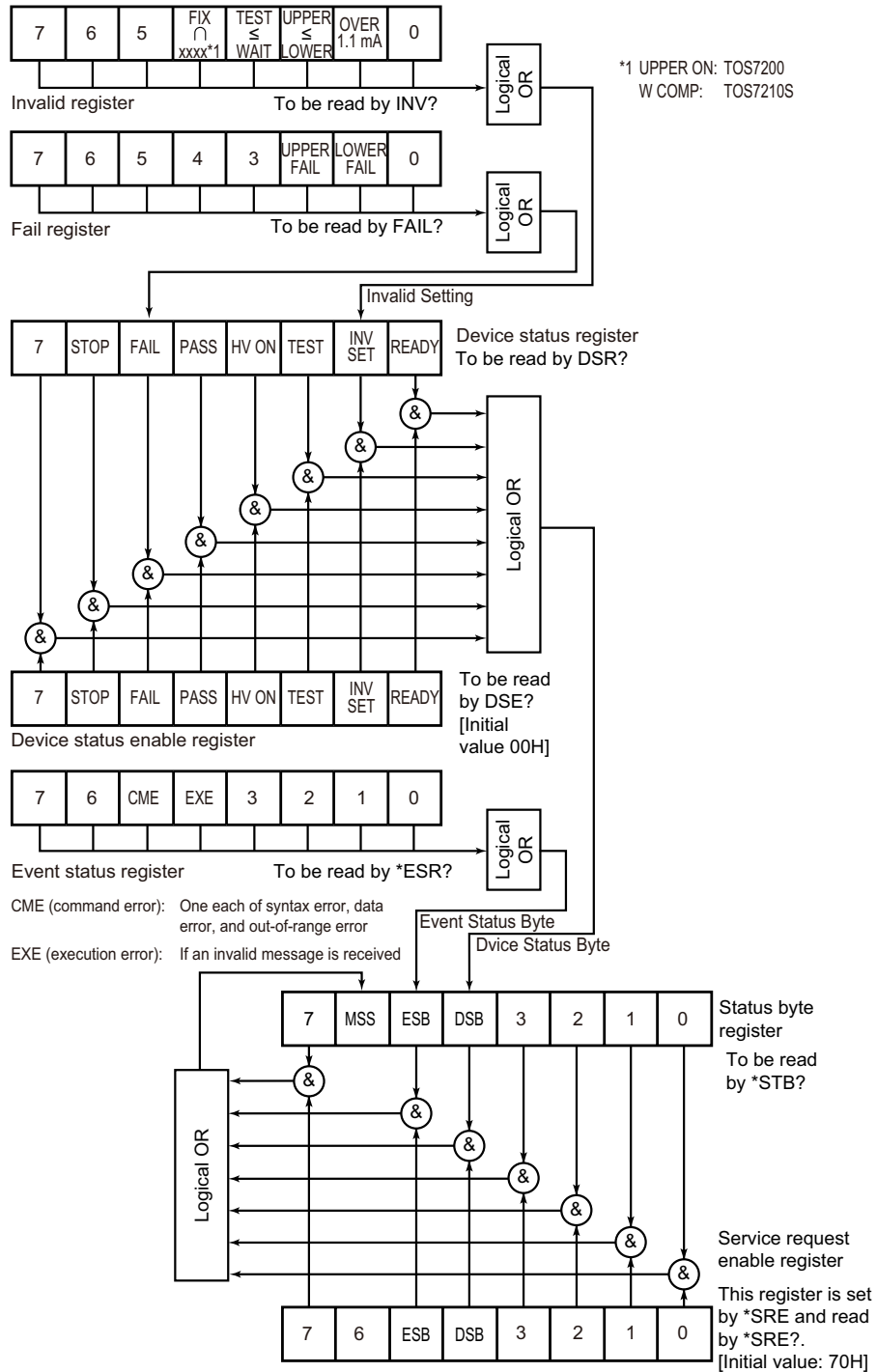

NOTE

- For the command messages of each register, the addition of "#H" allows use of hexadecimal data.
- For the query messages of each register, all response data is in decimal format.
- Each bit of each register indicates that it is set when it is "1" and reset when it is "0."
- The contents of enable registers are not backed up.

Status Byte Register, Service Request Enable Register

Bit	Description
7	Not used in the tester
6	MSS (Master Summary Status) This is the logical OR for the status byte register and service-request enable register and is read by *STB?.
5	ESB (Standard Event Status Bit) Indicates that any of the bits of the event status register has been set.
4	DSB (Device Status Bit) Indicates that any of the bits of the device status register has been set.
3	Not used in the tester
2	Not used in the tester
1	Not used in the tester
0	Not used in the tester

Event Status Register

Bit	Description
7	Not used in the tester
6	Not used in the tester
5	CME (Command Error) Indicates that a syntax error, data error, or out-of-range error has occurred.
4	EXE (Execution Error) Indicates that this bit has received an invalid message during a test.
3	Not used in the tester
2	Not used in the tester
1	Not used in the tester
0	Not used in the tester

Device Status Register, Device Status Enable Register

Bit	Description
7	Not used in the tester
6	STOP A test has stopped.
5	FAIL FAIL judgment
4	PASS PASS judgment
3	HV ON State of voltage output
2	TEST State of test voltage output
1	INV SET (Invalid setting) Invalid setting state in which the LOWER, UPPER, WAIT, or UPPER ON (TOS7200)/ W COMP (TOS7210s) LED is blinking
0	READY Ready state

Fail Register

Bit	Description
7	Not used in the tester
6	Not used in the tester
5	Not used in the tester
4	Not used in the tester
3	Not used in the tester
2	UPPER FAIL Indicates that a FAIL judgment has been made with respect to the upper resistance.
1	LOWER FAIL Indicates that a FAIL judgment has been made with respect to the lower resistance.
0	Not used in the tester

Invalid Register

Bit	Description
7	Not used in the tester
6	Not used in the tester
5	Not used in the tester
4	FIX \cap xxx ^{*1} Set if the fixed range is selected with the upper judgment set to ON.
3	TEST \leq WAIT Set if the wait time is equal to or greater than the test time with the timer function set to ON.
2	UPPER \leq LOWER Set if the lower resistance is equal to or above the upper resistance with the upper and lower judgments set to ON.
1	OVER 1.1 mA Set if a value obtained by dividing the test voltage by the lower resistance exceeds 1.1 mA.
0	Not used in the tester

*1. UPPER ON (TOS7200) / W COMP (TOS7210S)

Error Register

Bit	Description
7	Not used in the tester
6	Not used in the tester
5	Not used in the tester
4	Not used in the tester
3	Invalid message Indicates that an invalid message has been received.
2	Out-of-range error Indicates that an out-of-range error has occurred.
1	Data Error Indicates that a data error has occurred.
0	Syntax Error Indicates that a header error has occurred.

5 List of Device Messages

An item in parentheses in the Header column indicates the abbreviation of a device message.

Note: A check (✓) is used to indicate available device messages, even during a test or while a PASS or FAIL judgment is being made, while a cross (✗) is used to indicate those not available.

List of Register-Related and General Purpose Device Messages

Header	Data				Function and response data	Note
	Min	Max	Resolution	Unit		
*CLS					Clears the status byte register, event status register, device status register, fail register, invalid setting register, and error register.	✓
*ESR?					Returns the value of the event status register and clears this register.	✓
*IDN?					Returns "KIKUSUI ELECTRONICS CORP.,TOSmmmm,0,x.xx. mmmm: "7200" for the TOS7200, "7210S" for the TOS7210S.	✓
*RST					Initializes the device (to the factory default settings).	✓
*SRE	0	255			Sets the service request enable register.	✓
*SRE?					Returns the value of the service request enable register.	✗
*STB?					Returns the value of the status byte register.	✓
CLR					Clears all registers and sets a stop flag (this message is the same as DCL).	✓
DSE	0	255			Sets the device status enable register.	✗
DSE?					Returns the value of the device status enable register.	✓
DSR?					Returns the value of the device status register.	✓
ERR?					Returns the value of the error register and clears this register.	✓
FAIL?					Returns the value of the fail register.	✓
INVALID? (INV?)					Returns the value of the invalid setting register.Returns the value of the invalid setting register.	✓
SILENT (SIL)	0	1			Acknowledge message	✓
SILENT? (SIL?)					Returns the value of an acknowledge message.	✓
START (STAR)					Starts a test.	✗
STOP					Stops a test. Also cancels a FAIL or PASS judgment or PASS HOLD status.	✓

List of Device Messages Relating to Tests

Header	Data				Function and response data	Note
	Min	Max	Resolution	Unit		
AUTORANGE (AUTOR)	OFF(0)	ON (1)			Sets ON/OFF for auto-range.	✗
AUTORANGE? (AUTOR?)					Returns ON/OFF for auto-range . (ON: 1; OFF: 0)	✓
LOWER (LOW)	0.01E6	9.996	0.01E6	Ω	Lower resistance	✗
	10.0E6	99.9E6	0.1E6	Ω		
	100E6	5000E6	1E6	Ω		
	OFF (0)	ON (1)			Sets ON/OFF for lower judgment.	
LOWER? (LOW?)					Returns the lower resistance and ON/OFF for lower judgment. (0.01E6 Ω to 5 000E6 Ω, ON:1, OFF:0)	✓
MON?					Returns a monitored voltage (TOS7200: 0 V to 1 020 V, TOS7210S: 0 V to 2040 V), monitored resistance (0.01E6 Ω to 5 000E6 Ω), monitored current (TOS7210S only 0.000 μA to 1 900 μA), and elapsed (remaining) time (0 s to 999 s), in that order, delimiting them with ", ". Returns the previous test results in any case other than a test in progress.	
RDATA? (RDAT?)					Returns a monitored resistance value. (0.01E6 Ω to 5 000E6 Ω)	✓
IDATA? (IDAT?) (TOS7210S only)					Returns a monitored current value. (0.000 μA to 1 900 μA)	✓
TIMER	0.5	99.9	0.1	s	Timer set value	✗
	100	999	1	s		
	OFF (0)	ON (1)			Sets ON/OFF for the timer function.	
TIMER?					Returns the timer set value and ON/OFF for the timer function. (0.5 s to 999 s, ON:1, OFF:0)	✓
TESTV (TES)	10	TOS7200: 1020 TOS7210S: 2040	1	V	Sets the test voltage.	✗
TESTV? (TES?)					Returns the test-voltage set value. (TOS7200: 0 V to 1020 V, TOS7210S: 0 V to 2040 V)	✓
POLARITY (POL) (TOS7210S only)	0	1			Sets the test voltage polarity. (Positive: 1, negative: 0)	✗
POLARITY? (POL?) (TOS7210S only)					Returns the test voltage polarity. (Positive: 1, negative: 0)	✓
TIME?					Returns the elapsed (remaining) time. (0 s to 999 s) When TIMER is OFF, the elapsed time is returned. When TIMER is ON, the remaining test time is returned.	✓
UPPER (UPP)	0.01E6	9.99E6	0.01E6	Ω	Upper resistance	✗
	10.0E6	99.9E6	0.1E6	Ω		
	100E6	5000E6	1E6	Ω		
	OFF (0)	ON (1)			Sets ON/OFF for upper judgment.	
UPPER? (UPP?)					Returns the upper resistance and ON/OFF for upper judgment (0.01E6 Ω to 5 000E6 Ω, ON:1, OFF:0)	✓
VDATA? (VDAT?)					Monitored voltage (TOS7200: 0 V to 1 020 V, TOS7210S: 0 V to 2040 V)	✓
WAITTIME (WTIM)	0.3	10	0.1	s	Sets the wait time.	✗
WAITTIME? (WTIM?)					Returns the set value for the wait time. (0.3 s to 10.0 s)	✓

List of System-Related Device Messages

Header	Data				Function and response data	Note
	Min	Max	Resolution	Unit		
PASSHOLD (PHOL)	OFF (0)	ON (1)			Sets ON/OFF for pass hold.	✘
PASSHOLD? (PHOL?)					Returns ON/OFF for pass hold. (ON:1, OFF:0)	✔
BUZZERVOL (BVOL)	0	9	1		Sets the buzzer volume.	✘
BUZZERVOL? (BVOL?)					Sets the set value of the buzzer volume. (0 to 9)	✔
MOMENTARY (MOM)	OFF (0)	ON (1)			Sets ON/OFF for momentary.	✘
MOMENTARY? (MOM?)					Returns ON/OFF for momentary. (ON: 1; OFF: 0)	✔
FAILMODE (FMOD)	OFF (0)	ON (1)			Sets ON/OFF for fail mode.	✘
FAILMODE? (FMOD?)					Returns ON/OFF for fail mode. (ON: 1; OFF: 0)	✔
DOUBLEACTION (DAC)	OFF (0)	ON (1)			Sets ON/OFF for double action.	✘
DOUBLEACTION? (DAC?)					Returns ON/OFF for double action. (ON: 1; OFF: 0)	✔

List of Memory-Related Device Messages

Header	Data				Function and response data	Note
	Min	Max	Resolution	Unit		
RECALL (REC)	0	9	1		Recalls memory.	✘
STORE (STOR)	0	9	1		Stores the current panel settings in memory.	✘
MEMORY (MEM)	0	9	1		Stores the following data in a specified memory number.	✘
	10	TOS7200: 1020 TOS7210S: 2040	1	V	Test voltage	
	0.01E6	9.99E6	0.01E6	Ω	Lower resistance	
	10.0E6	99.9E6	0.1E6	Ω		
	100E6	5000E6	1E6	Ω		
	0.01E6	9.99E6	0.01E6	Ω	Upper resistance	
	10.0E6	99.9E6	0.1E6	Ω		
	100E6	5000E6	1E6	Ω		
	0.5	99.9	0.1	s	Test time	
	100	999	1	s		
	OFF (0)	ON (1)			Sets ON/OFF for upper judgment.	
	OFF (0)	ON (1)			Timer ON/OFF	
0.3	10	0.1	s	Wait time		
MEMORY? (MEM?)	0	9	1		Returns the contents of a specified memory number (test voltage, lower resistance, upper resistance, test time, ON/OFF for upper judgment, timer ON/OFF, and wait time)	✓

Index

AUTORANGE(AUTOR)	14
BUZZERVOL (BVOL)	20
CLR	11
DOUBLEACTION (DAC)	22
DSE	11
DSR	11
ERR	12
FAIL	12
FAILMODE (FMODE)	21
IDATA (IDAT)	16
INVALID (INV)	12
LOWER (LOW)	14
MEMORY (MEM)	24
MOMENTARY (MOM)	21
MON	15
PASSHOLD (PHOL)	20
POLARITY(POL)	17
RDATA (RDAT)	15
RECALL (REC)	23
SILENT (SIL)	13
START	13
STOP	13
STORE (STOR)	23
TESTV (TES)	17
TIME	18
TIMER	16
UPPER (UPP)	18
VDATA (VDAT)	19
WAITTIME (WTIM)	19
*CLS	9
*ESR	9
*IDN	9
*RST	10
*SRE	10
*STB	10

D

device message	8
----------------------	---

L

LOCAL key	5
localmode, switching	5

M

message	
list	29

P

program message	6
-----------------------	---

R

RS232C flow control	4
RS232C interface	3
RS232C protocol	4

T

terminator	7
------------------	---



If the manual gets lost or soiled, a new copy can be provided for a fee. In either case, please contact your Kikusui agent or distributor. At that time, inform your agent or distributor of the "Part No." written on the front cover of this manual.

Every effort has been made to ensure the accuracy of this manual. However, if you have any questions or find any errors or omissions, please contact your Kikusui agent or distributor.

After you have finished reading this manual, store it so that you can use it for reference at any time.

KIKUSUI ELECTRONICS CORP.

1-1-3 Higashiyamata, Tsuzuki-ku, Yokohama,
224-0023, Japan

Tel: +81-45-482-6353 Fax: +81-45-482-6261



Website

<http://www.kikusui.co.jp/en>